

127-1263

AOP534 LED-FT

**we-ef**



#### Description

IP55, Class I. IK10. Marine-grade, die-cast aluminium alloy. 5CE superior corrosion protection including PCS hardware. Polycarbonate lens. Silicone rubber gasket.

Integral EC electronic converter. DALI interface. CAD-optimised lens for superior illumination and glare control.

Weight	7.60 kg
Light distribution	symmetric distribution [C60]
Light source	LED-FT-24W / 700 mA - 4000 K
CRI	80
Power supply	EC
BUG	B1 U2 G1
LEDs	1
Rated input power	27 W

#### Rated lumens (lm)

LED Lumen	3008.5
Total Lumen	3008.5
Ta	25

#### Nominal Lumen (lm)

LED Lumen	4400
Total Lumen	4400
Tc	25

**WE-EF LIGHTING (Thailand) Co., Ltd.**

57 Moo 5, Kingkaew Rd., Bangplee, 10540 Samutprakarn - Phone: +66 2 738 96 20 - Fax: +66 2 738 96 29

<https://we-ef.com/asia>

Subject to technical changes and errors. - Generated on 23/11/2024

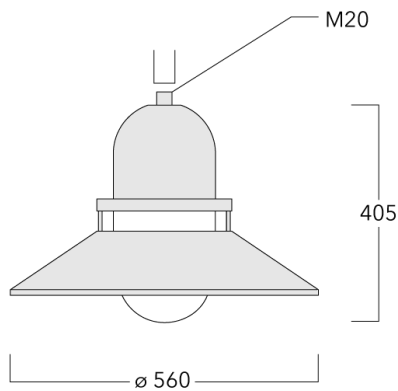

## Specifications

### Material description

Body	Marine-grade, die-cast aluminium alloy
Lens	Polycarbonate lens
Colours	<div style="display: flex; align-items: center;"> <div style="width: 20px; height: 15px; background-color: black; margin-right: 5px;"></div> <span>RAL9004 Signal black</span> </div> <div style="display: flex; align-items: center; margin-top: 5px;"> <div style="width: 20px; height: 15px; background-color: grey; margin-right: 5px;"></div> <span>RAL9007 Grey aluminium</span> </div> <div style="display: flex; align-items: center; margin-top: 5px;"> <div style="width: 20px; height: 15px; background-color: darkgrey; margin-right: 5px;"></div> <span>RAL7016 Anthracite grey</span> </div> <div style="display: flex; align-items: center; margin-top: 5px;"> <div style="width: 20px; height: 15px; background-color: white; margin-right: 5px;"></div> <span>RAL9016 Traffic white</span> </div>
Gasket	Silicone rubber gasket
Fasteners	PCS hardware
Ingress protection	IP55
Impact resistance	IK10
Corrosion resistance	5CE
Windage	0.12 m <sup>2</sup>

### Electrical description

Power supply	220-240V / 50-60 Hz
Driver / Ballast	Integral electronic converter with DALI interface
Power factor	> 0.9

### Additional information

Lifetime	T <sub>a</sub> =25° L70B50 > 50000h
BUG Rating	Please see individual Spec Sheets for classification of Backlight, Uplight and Glare

#### WE-EF LIGHTING (Thailand) Co., Ltd.

57 Moo 5, Kingkaew Rd., Bangplee, 10540 Samutprakarn - Phone: +66 2 738 96 20 - Fax: +66 2 738 96 29

<https://we-ef.com/asia>

Subject to technical changes and errors. - Generated on 23/11/2024

**Mounting Accessories**

**Wall and pole brackets BA**

Description	Part ID	C1	D × L1	H1	H2	M1	Weight (kg)	C	H
Wall bracket BA0-420, single	300-0152	460		1000	132	9	2	460	1000

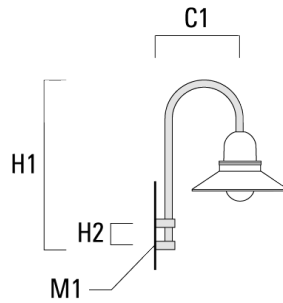

Pole bracket BA1-420, single	300-0099	420	76 x 80	1000			4	420	1000
------------------------------	----------	-----	---------	------	--	--	---	-----	------

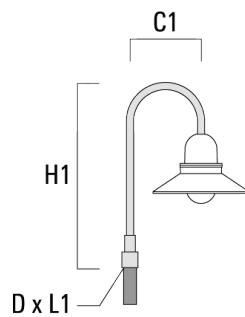

**AOP534 LED-FT**

Description	Part ID	C1	D x L1	H1	H2	M1	Weight (kg)	C	H
Pole bracket BA2-420, double	300-0104	500	76 x 80	1000			8	500	1000

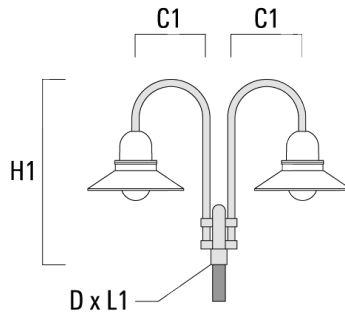

Pole bracket BA3-420, triple	300-0109	500	76 x 80	1000			10	500	1000
------------------------------	----------	-----	---------	------	--	--	----	-----	------

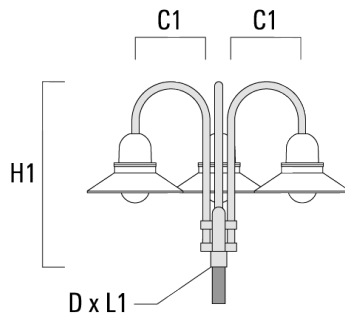

**Wall and pole brackets BC**

Description	Part ID	C1	H1	H2	M1	Weight (kg)	C	H
BC0-420 Wall bracket, single	300-0808	460	1230	300	8	2.30	460	1230

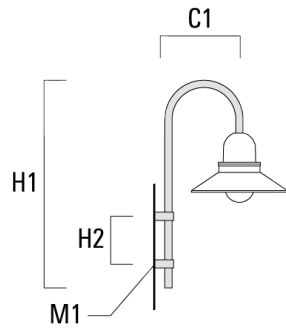

BC1-420 Pole bracket, single	300-0768	500	1230	300	8	2.30	500	1230
------------------------------	----------	-----	------	-----	---	------	-----	------

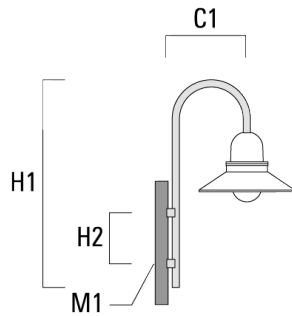

**AOP534 LED-FT**

Description	Part ID	C1	H1	H2	M1	Weight (kg)	C	H
BC2-420 Pole bracket, double	300-0767	500	1230	300	8	4.60	500	1230

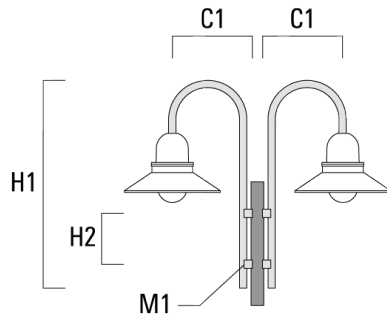

**Wall and pole brackets DA**

Description	Part ID	C1	C2	D × L1	H1	Weight (kg)	C	H
Wall bracket DA0-500, single	300-0146	510	70		650	5.70	510	650

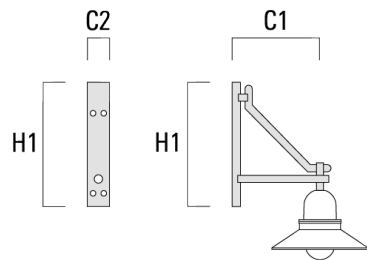

**AOP534 LED-FT**

Description	Part ID	C1	C2	D × L1	H1	Weight (kg)	C	H
Pole bracket DA1-500, single	300-0138	510		76 x 80	700	5.70	510	700

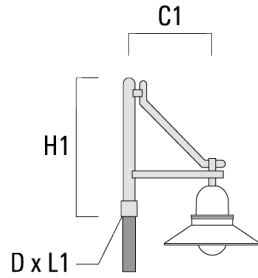

Pole bracket DA2-500, double	300-0141	510		76 x 80	700	8.30	510	700
------------------------------	----------	-----	--	---------	-----	------	-----	-----

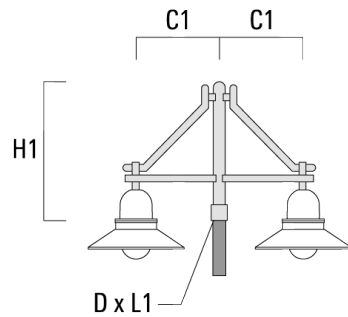

**AOP534 LED-FT**

Description	Part ID	C1	C2	D × L1	H1	Weight (kg)	C	H
Pole bracket DA3-500, triple	300-0144	510		76 x 80	700	10.90	510	700

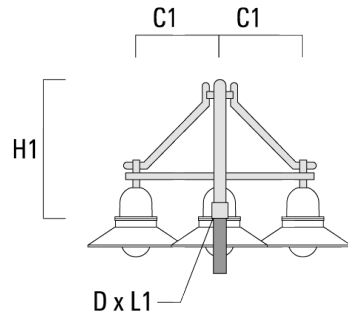

**Wall and pole brackets DB**

Description	Part ID	C1	C2	D × L1	H1	Weight (kg)	C	H
Wall bracket DB0-500, single	300-0169	510	70		650	5.50	510	650

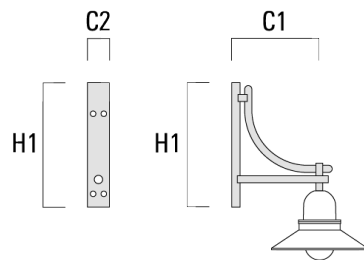



**AOP534 LED-FT**

Description	Part ID	C1	C2	D × L1	H1	Weight (kg)	C	H
Pole bracket DB1-500, single	300-0190	510		76 x 80	700	5.50	510	700

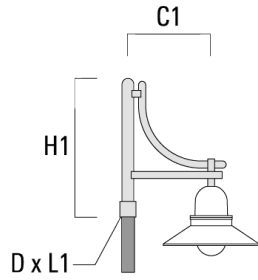

Pole bracket DB2-500, double	300-0191	510		76 x 80	700	7.90	510	700
------------------------------	----------	-----	--	---------	-----	------	-----	-----

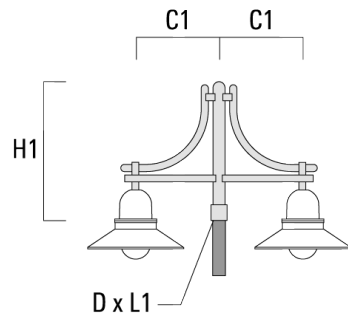

**AOP534 LED-FT**

Description	Part ID	C1	C2	D × L1	H1	Weight (kg)	C	H
Pole bracket DB3-500, triple	300-0192	510		76 x 80	700	10.30	510	700

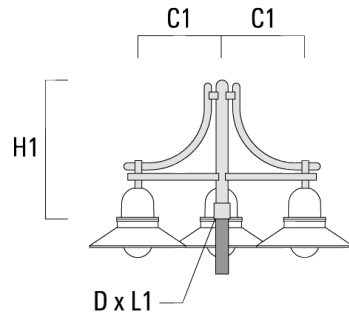

**Wall and pole brackets DS**

Description	Part ID	C1	C2	D × L1	H1	Weight (kg)	C	H
Wall bracket DS0-500, single	300-0064	510	70		650	2.50	510	650

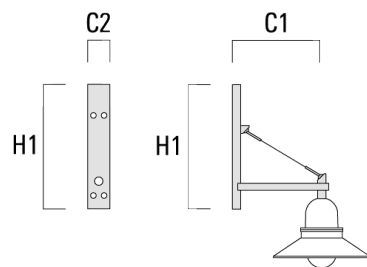

**AOP534 LED-FT**

Description	Part ID	C1	C2	D x L1	H1	Weight (kg)	C	H
Pole bracket DS1-500, single	300-0063	510		76 x 80	725	3.90	510	725

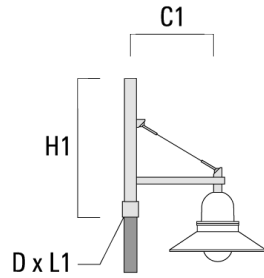

Pole bracket DS2-500, double	300-0066	510		76 x 80	725	5.30	510	725
------------------------------	----------	-----	--	---------	-----	------	-----	-----

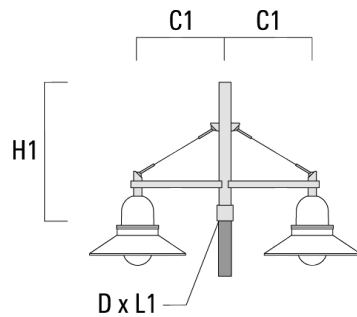

127-1263

AOP534 LED-FT

**we-ef**

Description	Part ID	C1	C2	D x L1	H1	Weight (kg)	C	H
Pole bracket DS3-500, triple	300-0069	510		76 x 80	725	6.70	510	725

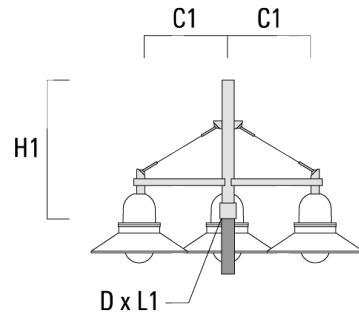

**WE-EF LIGHTING (Thailand) Co., Ltd.**

57 Moo 5, Kingkaew Rd., Bangplee, 10540 Samutprakarn - Phone: +66 2 738 96 20 - Fax: +66 2 738 96 29

<https://we-ef.com/asia>

Subject to technical changes and errors. - Generated on 23/11/2024