



### Description

IP67, Class I. IK09. Marine-grade, all aluminium construction. 5CE superior corrosion protection + primer including PCS hardware. PMMA cover. Silicone rubber gasket. Linear PMMA LED lens. 1.2 m connecting cable, UV stabilized, PVC free. Luminaire is factory sealed and does not need to be opened during installation and can be tilted up to 180°. Integral LED driver with DALI interface.

Separate LED driver on request.

Weight	4.00 kg
Light distribution	symmetric linear, medium beam [LM]
Light source	LED-64/40W / 225 mA - 4000 K
CRI	80
Power supply	EC
LEDs	64
Rated input power	44 W
<b>Nominal Lumen (lm)</b>	
LED Lumen	90
Total Lumen	5760
T <sub>j</sub>	85
<b>Rated lumens (lm)</b>	
LED Lumen	66.9
Total Lumen	4280.8
T <sub>a</sub>	25

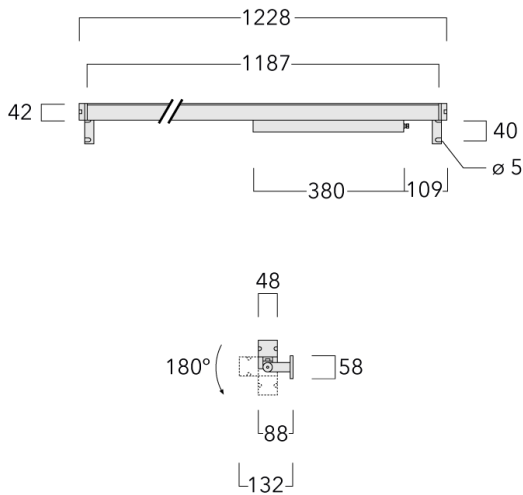

## Specifications

### Material description

Body	Marine-grade, all-aluminium construction
Lens	PMMA
Colours	<div style="display: flex; align-items: center;"> <div style="width: 20px; height: 15px; background-color: black; margin-right: 5px;"></div> <span>RAL9004 Signal black</span> </div> <div style="display: flex; align-items: center; margin-top: 5px;"> <div style="width: 20px; height: 15px; background-color: #cccccc; margin-right: 5px;"></div> <span>RAL9006 White aluminium</span> </div> <div style="display: flex; align-items: center; margin-top: 5px;"> <div style="width: 20px; height: 15px; background-color: #808080; margin-right: 5px;"></div> <span>RAL9007 Grey aluminium</span> </div>
Gasket	Silicone rubber gasket
Fasteners	PCS Polymer Coated Stainless Steel Hardware (unpainted)
Ingress protection	IP67
Impact resistance	IK09
Corrosion resistance	5CE+Primer

### Electrical description

Power supply	230V / 50 Hz
Driver / Ballast	Integral LED driver with DALI Interface

### Additional information

Lifetime	Ta=40° L90B10 > 90000h
Warranty	The product is supplied with 10-year warranty. Please refer to the LED Warranty Statement located on <a href="http://www.we-ef.com">www.we-ef.com</a> for further details.