



Description

IP66. Post top luminaire with shielded light source and canopy highlight feature.

Weight	13.00 lb
Light distribution	[S65] Type III Medium
Light source	LED-9/27W / 1050 mA - 4000 K
CRI	80
Power supply	electronic gear
LEDs	9
Rated input power	30 W
Nominal Lumen (lm)	
LED Lumen	450
Total Lumen	4050
Tj	85
Rated lumens (lm)	
LED Lumen	380.2
Total Lumen	3421.5
Ta	25

WE-EF LIGHTING USA, LLC

410-D Keystone Drive, 15086 Warrendale, PA 15086 - Phone: +1 724 742 0030

customersupport.usa@we-ef.com - <https://we-ef.com/us>

Subject to technical changes and errors. - Generated on 10/23/2024

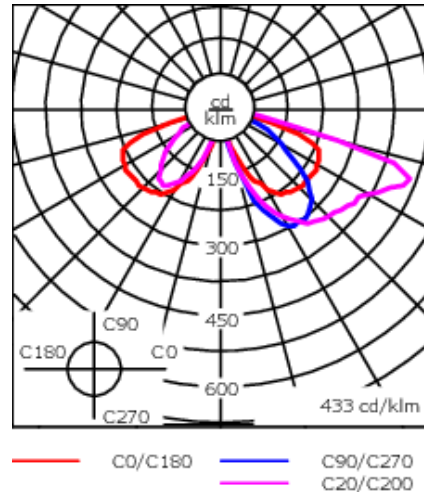
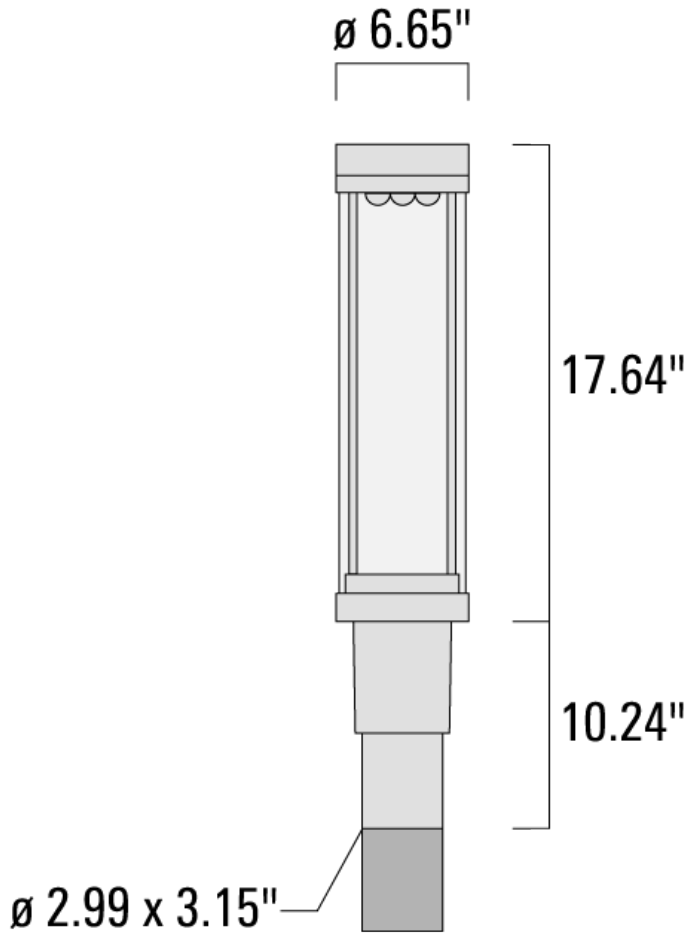

Specifications

WE-EF LIGHTING USA, LLC

410-D Keystone Drive, 15086 Warrendale, PA 15086 - Phone: +1 724 742 0030

customersupport.usa@we-ef.com - <https://we-ef.com/us>





Subject to technical changes and errors. - Generated on 10/23/2024

115-1294

ZFT440 LED

we-ef

Material description

Body	Marine-grade die-cast aluminium alloy
Lens	Clear polycarbonate lens
Colors	 RAL9004 Black  RAL9007 Grey Metallic  RAL9016 White  RAL8019 Dark Bronze
Gasket	Silicone rubber gasket
Fasteners	PCS Polymer Coated Stainless Steel hardware
Ingress protection	IP66
Impact resistance	IK09
Corrosion resistance	5CE
Windage	0.133 m ²

Electrical description

Power supply	Integral [ECG] LED driver in 120 or 277 volt.
Driver / Ballast	Integral EC electronic converter
Power factor	> 0.9

Additional information

Lifetime	Ta=25°/40° L90B10 > 90000h
Listings	Contact WE-EF USA for ETL/UL certification status.

WE-EF LIGHTING USA, LLC

410-D Keystone Drive, 15086 Warrendale, PA 15086 - Phone: +1 724 742 0030

customersupport.usa@we-ef.com - <https://we-ef.com/us>

Subject to technical changes and errors. - Generated on 10/23/2024

Mounting Accessories

Wall and pole brackets RZ

Description	Part ID	C1	D1	D2	D x L1	M1	Weight (lb)
RZ0-400 Wall bracket, single	115-1324	10.90"	9.1"	7.67"	3" x 3"	0.47"	7.72 lbs

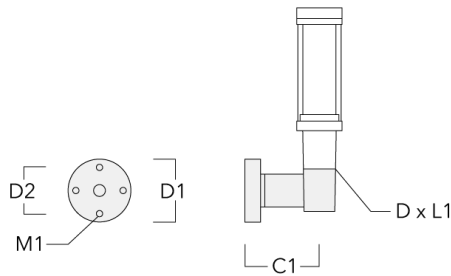

RZ2-400 Pole bracket, double	115-1323	10.16"			3" x 3"		10.8 lbs
------------------------------	----------	--------	--	--	---------	--	----------

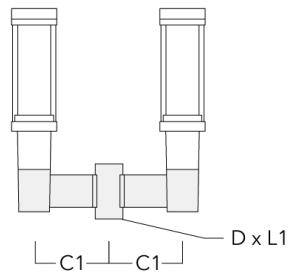

115-1294

ZFT440 LED

WE-EF LIGHTING USA, LLC

410-D Keystone Drive, 15086 Warrendale, PA 15086

Phone: +1 724 742 0030

customersupport.usa@we-ef.com

<https://we-ef.com/us>

Subject to technical changes and errors.

Generated on 10/23/2024

we-ef

A Fagerhult Group Company