



### Description

IP66, Class I. Class II on request. IK10. Marine-grade, die-cast aluminium alloy. 5CE superior corrosion protection including PCS hardware. Silicone CCG® Controlled Compression Gasket. Polycarbonate main lens. Integral EC electronic converter in thermally-separated compartment. Factory installed LED circuit board. CAD-optimised optics for superior illumination and glare control. Pre-wired post complete with cable connecting box and service door for mains connection.

Optional Eco Step Dim® Motion version available. To be specified at time of ordering.

Weight	11.50 kg
Light distribution	symmetric distribution [C60]
Light source	LED-FT-12W / 350 mA - 3000 K
CRI	80
Power supply	EC
LEDs	1
Rated input power	14 W

### Rated lumens (lm)

LED Lumen	1182.8
Total Lumen	1182.8
Ta	25

### Nominal Lumen (lm)

LED Lumen	2050
Total Lumen	2050
Tc	25

115-1933



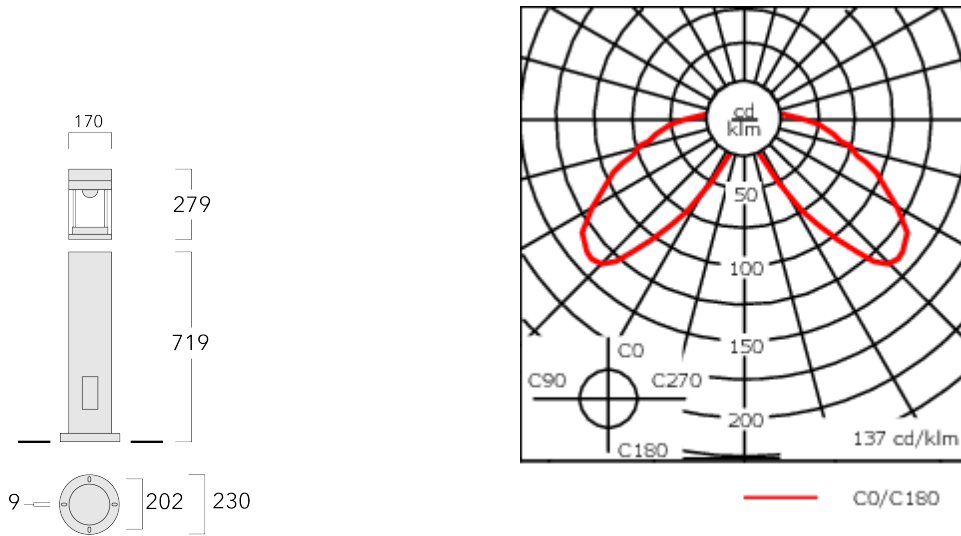

CTY150 LED-FT

**we-ef**



## Specifications

### Material description

Body	Marine-grade, die-cast aluminium alloy
Lens	Polycarbonate
Colours	 RAL9004 Signal black  RAL9006 White aluminium  RAL9007 Grey aluminium  RAL7016 Anthracite grey  RAL9016 Traffic white
Gasket	Silicone CCG® Controlled Compression Gasket
Fasteners	PCS Polymer Coated Stainless Steel Hardware
Ingress protection	IP66
Impact resistance	IK10
Corrosion resistance	5CE

### Electrical description

Power supply	220-240V / 50-60 Hz
Driver / Ballast	Standard. Optional DALI version available. To be specified at time of ordering.
Power factor	> 0.9
Surge protection	10/10kV (SP10)

#### Fagerhult Lighting Ltd

33-34 Dolben Street, SE1 0UQ London, United Kingdom

<https://we-ef.com/uk>

Subject to technical changes and errors. - Generated on 27/11/2024

**115-1933**

**CTY150 LED-FT**

**we-ef**

**Additional information**

---

Lifetime Ta=25° L70B50 > 50000h

Energy efficiency class D-E (Light source)

---

### Mounting Accessories

#### Planted root

Description	Part ID	D1	D2	D3	D4	H1	H2	M1	M2	Weight (kg)
Planted root ESV4	300-0464	220	190	102	108	400	350	8	6	4.30



## Optical Accessories

## Light shield

Description	Part ID	Additional information	H1
LS180-[C60]	159-0321		120



LS180	430-0029	Glare Shield for backlight spill. Glare Shield factory-installed or available as retrofit kit. Suitable for [S60], [S65], [S70], [R65], [P65] lenses. Must be specified at time of ordering.	
-------	----------	--	--

**Control**

**Eco Step Dim® Motion**

---

Description	Part ID
Eco Step Dim® Motion - Linked-Primary	430-0030

---



---

Eco Step Dim® Motion - Linked-Secondary	430-0031
---	----------

---



115-1933

CTY150 LED-FT

**we-ef**

---

Description	Part ID
Eco Step Dim® Motion - Stand-Alone	430-0037

---

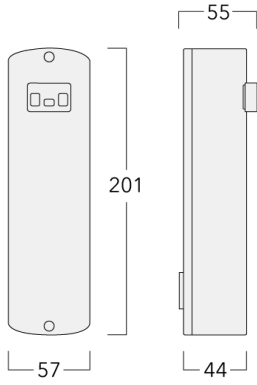

**Fagerhult Lighting Ltd**

33-34 Dolben Street, SE1 0UQ London, United Kingdom

<https://we-ef.com/uk>

Subject to technical changes and errors. - Generated on 27/11/2024