



### Description

IP66, Class I or Class II. IK08. Marine-grade die-cast aluminium alloy. 5CE superior corrosion protection + primer including PCS hardware. Silicone CCG® Controlled Compression Gasket. UV stabilised PC lens in RFC® technology. Integrated heat sinks. Easy removal and replacement of LED board. CAD optimised OLC® PMMA lens for superior illumination and glare control. DALI. The luminaire is factory-sealed and does not need to be opened during the installation.

PC Amber and 2200 K available on request (to be specified at time of ordering).

Max drive current:

PC Amber - 700 mA

2200 K - 1050 mA (CRI70 only)

Spigot D: 76 x 80 mm (optional 60 x 80 mm).

Weight	4.70 kg
Light distribution	asymmetric, side throw [S65]
Light source	LED-12/12W / 350 mA - 4000 K
CRI	80
Power supply	EC
LEDs	12
Rated input power	13.9 W

### Nominal Lumen (lm)

LED Lumen	170
Total Lumen	2040
Tj	85

### Rated lumens (lm)

LED Lumen	159.5
Total Lumen	1913.7
Ta	25

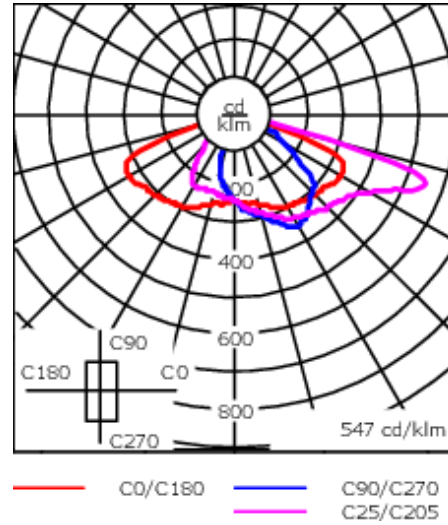
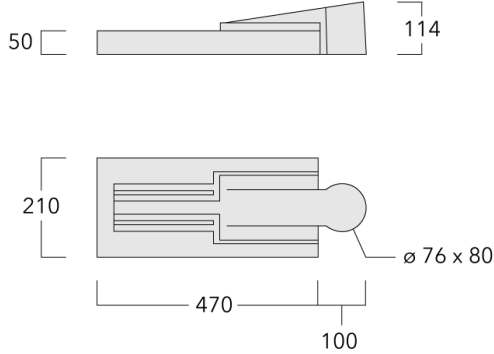

**Specifications**

**Material description**

Body	Marine-grade, die-cast aluminium alloy
Lens	UV stabilised PC lens in RFC® technology.
Colours	<div style="display: flex; align-items: center;"> <div style="width: 20px; height: 15px; background-color: black; margin-right: 5px;"></div> <span>RAL9004 Signal black</span> </div> <div style="display: flex; align-items: center; margin-top: 5px;"> <div style="width: 20px; height: 15px; background-color: #cccccc; margin-right: 5px;"></div> <span>RAL9006 White aluminium</span> </div> <div style="display: flex; align-items: center; margin-top: 5px;"> <div style="width: 20px; height: 15px; background-color: #808080; margin-right: 5px;"></div> <span>RAL9007 Grey aluminium</span> </div>
Gasket	Silicone CCG® Controlled Compression Gasket
Fasteners	PCS Polymer Coated Stainless Steel Hardware (unpainted)
Ingress protection	IP66
Impact resistance	IK08
Corrosion resistance	5CE+Primer
Windage	0.108 m <sup>2</sup>

**Electrical description**

Power supply	230V / 50 Hz
Driver / Ballast	Integral EC electronic converter. DALI
Power factor	> 0.9
Surge protection	In-pole surge protection SP10 device supplied. Please refer to WE-EF installation instructions for details. Use suffix +A for Integral surge protection.

**Additional information**

---

Lifetime	Ta=40° L90B10 > 90000h
Warranty	The product is supplied with 10-year warranty. Please refer to the LED Warranty Statement located on <a href="http://www.we-ef.com">www.we-ef.com</a> for further details.

---

**Control****Eco Step Dim® Basic**

Description	Part ID
Eco Step Dim® Basic LED	430-0001

**Eco Step Dim® Advanced**

Description	Part ID
Eco Step Dim® Advanced LED	430-0002

**R2C Ready to Connect**

Description	Part ID
R2C Ready to Connect (top)	430-0019
R2C Ready to Connect (below)	430-0027
R2C Ready to Connect (top and below)	430-0032

**Mounting Accessories**

**Wall and pole brackets RV**

Description	Part ID	Additional information	C1	C2	C3	D1	D × L1	H1	H2	M1	M2	Weight (kg)	C	D	H
RV0 Wall Bracket	108-0979	RV0 Wall bracket	108	100	60			200	160	38	12	2.00	108		

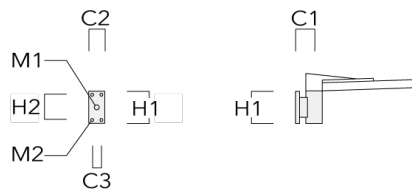

RV2-76 Pole bracket, double	108-0980		147				76 x 100					4.80	147	76	200
-----------------------------	----------	--	-----	--	--	--	----------	--	--	--	--	------	-----	----	-----

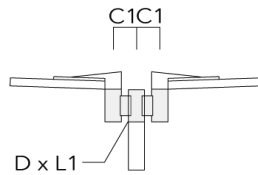

**VFL520 LED**

Description	Part ID	Additional information	C2	C3	D1	D x L1	H1	H2	M1	M2	Weight (kg)	C	D	H
RV2-60 Pole bracket, double	108-0981	147				60 x 100					4.80	147	60	200

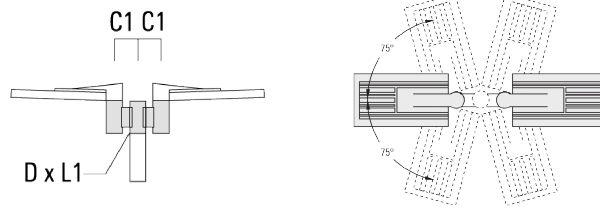

RV5 Pole bracket	108-0982	108			76-240						1.70	106	200
------------------	----------	-----	--	--	--------	--	--	--	--	--	------	-----	-----

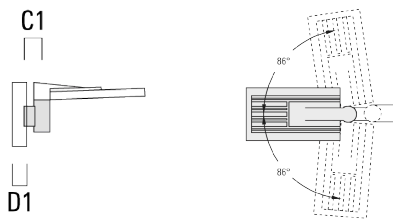

**Post top fitter AKV**

Description	Part ID	C1	D × L1	D × L2	H1	Weight (kg)
AKV2-76	300-0053	180	76x100	76x80	235	1.50

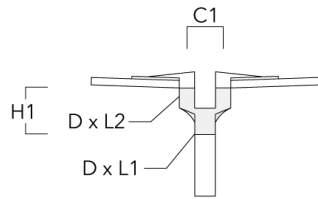

## Optical Accessories

### Light shield

Description	Part ID	Additional information
LS180-[A60]	003-4018	Glare Shield for backlight spill. Glare Shield factory-installed or available as retrofit kit. Suitable for [A60] lenses. Must be specified at time of ordering.
LS180	003-4019	Glare Shield for backlight spill. Glare Shield factory-installed or available as retrofit kit. Suitable for [S60], [S65], [S70], [R65], [P65] lenses. Must be specified at time of ordering.