



**Description**

IP66, Class I or Class II. IK08. Marine-grade, die-cast aluminium alloy. 5CE superior corrosion protection including PCS hardware. Silicone CCG® Controlled Compression Gasket. RFC® Reflection Free Contour main lens. Integral EC electronic converter in thermally separated compartment. DALI. CAD-optimised optics for superior illumination and glare control. OLC® One LED Concept. Factory installed LED circuit board. The luminaire is factory-sealed and does not need to be opened during installation.

Optional 2200 K version available. To be specified at time of ordering.

Spigot Ø 60 x 80 mm optional available. Must be indicated during order placement.

Weight	4.70 kg
Light distribution	asymmetric, side throw beam [S65]
Light source	LED-12/12W / 350 mA - 4000 K
CRI	80
Power supply	EC
LEDs	12
Rated input power	13.9 W

**Nominal Lumen (lm)**

LED Lumen	170
Total Lumen	2040
Tj	85

**Rated lumens (lm)**

LED Lumen	159.5
Total Lumen	1913.7
Ta	25

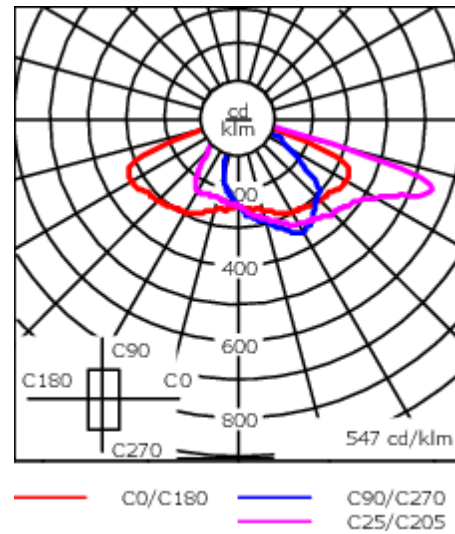
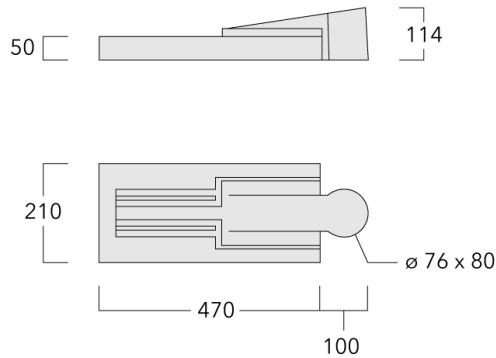

## Specifications

### Material description

Body	Marine-grade, die-cast aluminium alloy
Lens	RFC® Reflection Free Contour technology
Colours	<div style="display: flex; flex-direction: column; gap: 5px;"> <div><span style="display: inline-block; width: 15px; height: 15px; background-color: black; margin-right: 5px;"></span> RAL9004 Signal black</div> <div><span style="display: inline-block; width: 15px; height: 15px; background-color: #cccccc; margin-right: 5px;"></span> RAL9006 White aluminium</div> <div><span style="display: inline-block; width: 15px; height: 15px; background-color: #808080; margin-right: 5px;"></span> RAL9007 Grey aluminium</div> <div><span style="display: inline-block; width: 15px; height: 15px; background-color: #333333; margin-right: 5px;"></span> RAL7016 Anthracite grey</div> <div><span style="display: inline-block; width: 15px; height: 15px; background-color: #e0e0e0; margin-right: 5px;"></span> RAL9016 Traffic white</div> </div>
Gasket	Silicone CCG® Controlled Compression Gasket
Fasteners	PCS Polymer Coated Stainless Steel Hardware
Ingress protection	IP66
Impact resistance	IK08
Corrosion resistance	5CE
Windage	0.108 m <sup>2</sup>

### Electrical description

Power supply	220-240V / 50-60 Hz
Driver / Ballast	Integral EC electronic converter. DALI
Power factor	> 0.9
Surge protection	6/6 kV

#### Fagerhult Lighting Ltd

33-34 Dolben Street, SE1 0UQ London, United Kingdom

<https://we-ef.com/uk>

Subject to technical changes and errors. - Generated on 23/11/2024

**108-1485**

**VFL520 LED**

**we-ef**

**Additional information**

---

Lifetime Ta=25° L90B10 > 90000h

Energy efficiency class C-D (Light source)

---

**Fagerhult Lighting Ltd**

33-34 Dolben Street, SE1 0UQ London, United Kingdom

<https://we-ef.com/uk>

Subject to technical changes and errors. - Generated on 23/11/2024

## Control

### Eco Step Dim® Basic

Description	Part ID
Eco Step Dim® Basic LED	430-0001

### Eco Step Dim® Advanced

Description	Part ID
Eco Step Dim® Advanced LED	430-0002

### Eco Step Dim® Motion

Description	Part ID
Eco Step Dim® Motion - Linked	430-0021

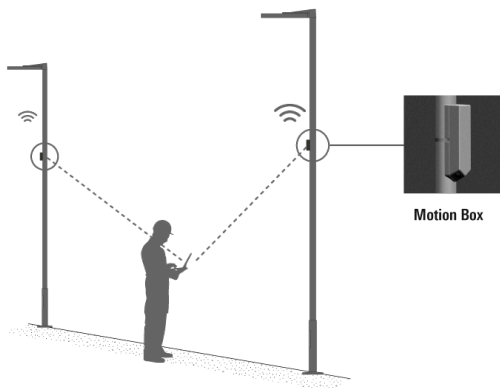

**VFL520 LED**

Description	Part ID
Eco Step Dim® Motion - Connected	430-0022

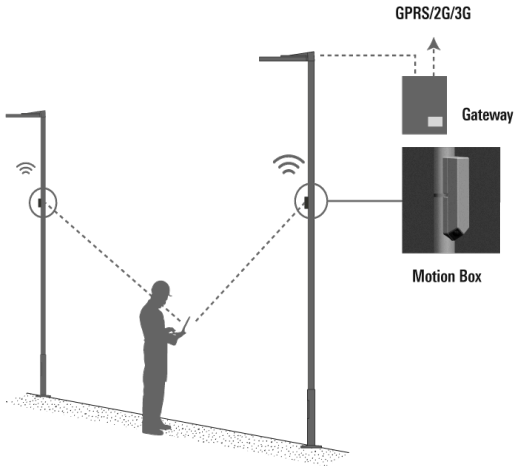

**R2C Ready to Connect**

Description	Part ID
R2C Ready to Connect (top)	430-0019
R2C Ready to Connect (below)	430-0027
R2C Ready to Connect (top and below)	430-0032

**Mounting Accessories**

**Wall and pole brackets RV**

Description	Part ID	Additional information	C1	C2	C3	D1	D × L1	H1	H2	M1	M2	Weight (kg)	C	D	H
RV0 Wall bracket	108-0979	RV0 Wall bracket	108	100	60			200	160	38	12	2.00	108		

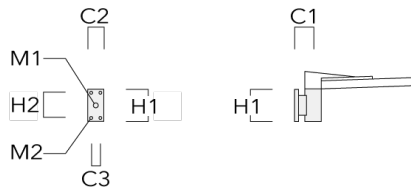

RV2-76 Pole bracket, double	108-0980		147				76 x 100					4.80	147	76	200
-----------------------------	----------	--	-----	--	--	--	----------	--	--	--	--	------	-----	----	-----

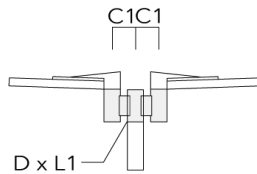

**VFL520 LED**

Description	Part ID	Additional information	C1	C2	C3	D1	D × L1	H1	H2	M1	M2	Weight (kg)	C	D	H
RV2-60 Pole bracket, double	108-0981	147					60 x 100					4.80	147	60	200

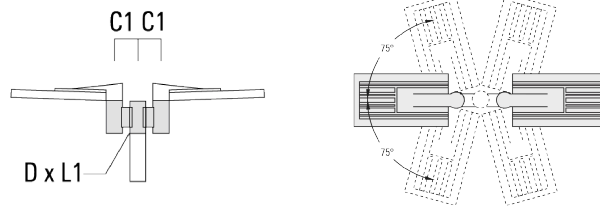

RV5 Pole bracket	108-0982	108				76-240						1.70	106	200
------------------	----------	-----	--	--	--	--------	--	--	--	--	--	------	-----	-----

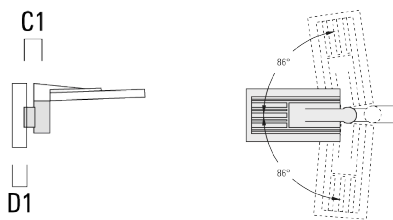

108-1485

VFL520 LED

**we-ef**

**Post top fitter AKV**

Description	Part ID	C1	D × L1	D × L2	H1	Weight (kg)
AKV2-76	300-0053	180	76x100	76x80	235	1.50

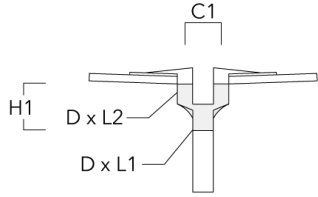



**Optical Accessories****Light shield**

Description	Part ID	Additional information
LS180-[A60]	430-0038	Light shield LS180 to greatly reduce or eliminate light pollution. PA injection moulded component, black matt. Suitable for asymmetric light distribution [A60].
LS180	430-0029	Glare Shield for backlight spill. Glare Shield factory-installed or available as retrofit kit. Suitable for [S60], [S65], [S70], [R65], [P65] lenses. Must be specified at time of ordering.