



### Description

IP66. Class I. IK08. Marine-grade, die-cast aluminium alloy. 5CE superior corrosion protection + primer including PCS hardware. RFC™ Reflection Free Contour main lens. Silicone CCG® Controlled Compression Gasket. Luminaire is factory-sealed and does not need to be opened during installation.

Integral EC electronic converter. Advanced thermal management protects LEDs while optimising lumens output. LED board can be easily removed for upgrading. CAD-optimised OLC® optics for superior illumination and glare control.

Maximum spacing for streetlighting applications depends on wattage and light distribution: 5.5 to 9 times the mounting height.

Weight	18.00 kg
Light distribution	asymmetric, side throw [S70]
Light source	LED-36/108W / 1050 mA - 3000 K
CRI	80
Power supply	EC
LEDs	36
Rated input power	115 W
<b>Nominal Lumen (lm)</b>	
LED Lumen	430
Total Lumen	15480
Tj	85
<b>Rated lumens (lm)</b>	
LED Lumen	333.9
Total Lumen	12019.2
Ta	25

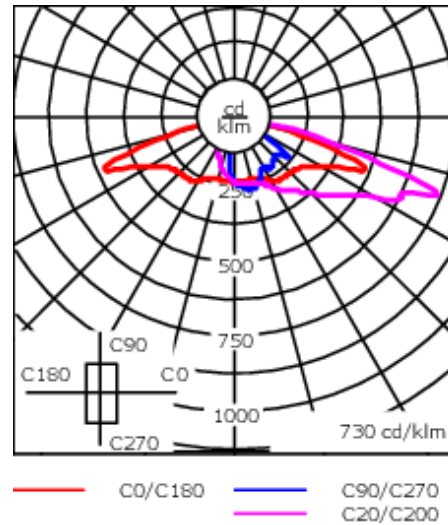
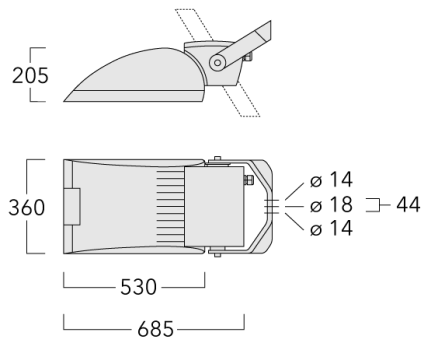

## Specifications

### Material description

Body	Marine-grade, die-cast aluminium alloy
Lens	Safety glass lens, hinged
Colours	<div style="display: flex; align-items: center;"> <div style="width: 20px; height: 15px; background-color: black; margin-right: 5px;"></div> <span>RAL9004 Signal black</span> </div> <div style="display: flex; align-items: center; margin-top: 5px;"> <div style="width: 20px; height: 15px; background-color: #cccccc; margin-right: 5px;"></div> <span>RAL9006 White aluminium</span> </div> <div style="display: flex; align-items: center; margin-top: 5px;"> <div style="width: 20px; height: 15px; background-color: #808080; margin-right: 5px;"></div> <span>RAL9007 Grey aluminium</span> </div>
Gasket	Silicone CCG® Controlled Compression Gasket
Fasteners	PCS Polymer Coated Stainless Steel Hardware (unpainted)
Ingress protection	IP66
Impact resistance	IK08
Corrosion resistance	5CE+Primer
Windage	0.210 m <sup>2</sup>

### Electrical description

Power supply	230V / 50 Hz
Driver / Ballast	Integral EC electronic converter
Surge protection	Internal surge protection SP10 device supplied.

**Additional information**

---

Lifetime	Ta=40° L90B10 > 90000h
Warranty	The product is supplied with 10-year warranty. Please refer to the LED Warranty Statement located on <a href="http://www.we-ef.com">www.we-ef.com</a> for further details.

---

**Mounting Accessories**

**Floodlight mounting bracket TA**

Description	Part ID	A	C1	D x L1	Weight (kg)	D	D x S
TA1-76 Single Mounting Fitter	310-9124			76 x 100	2.10	76 x 100	



TA2 Mounting bracket, double	310-9125			76 x 100	2.20	76 x 100	
------------------------------	----------	--	--	----------	------	----------	--

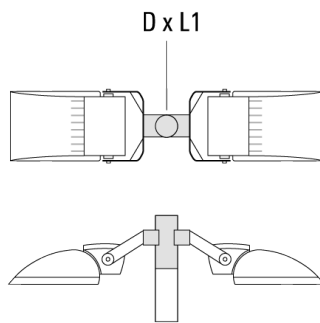

**FLA460 LED**

Description	Part ID	A	C1	D × L1	Weight (kg)	D	D × S
TA2 Mounting bracket, double* (Ø 76 x 200)	147-0024		130	76 x 200	1.90		76 x 200



TA2-L Mounting bracket, double (Ø 76 x 200)	147-0105	±90°	420	76 x 200	16.10		76 x 200
---	----------	------	-----	----------	-------	--	----------

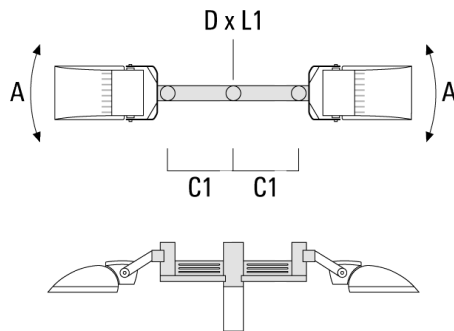

**FLA460 LED**

Description	Part ID	A	C1	D x L1	Weight (kg)	D	D x S
TA3 Mounting bracket, triple (Ø 89 x 200)	147-0025	±90°	650	89 x 200	17.90		89 x 200



TA2 Mounting bracket, double (Ø 108 x 200)	147-0097		130	108 x 200	7.50		108 x 200
--	----------	--	-----	-----------	------	--	-----------



**FLA460 LED**

Description	Part ID	A	C1	D x L1	Weight (kg)	D	D x S
TA2-L Mounting bracket, double (Ø 108 x 200)	147-0148	±90°	420	108 x 200	20.20		108 x 200



TA3-L Mounting bracket, triple (Ø 89 x 200)	147-0557	±9°	690	89 x 200	20.80		89 x 200
---	----------	-----	-----	----------	-------	--	----------



**FLA460 LED**

Description	Part ID	A	C1	D x L1	Weight (kg)	D	D x S
TA4-L Mounting bracket, quad (Ø 89 x 200)	147-0465	±9°	690	89 x 200	22.60		89x200



TA3-L Mounting bracket, triple (Ø 108 x 200)	147-0556	±9°	690	108 x 200	24.20		108 x 200
--	----------	-----	-----	-----------	-------	--	-----------



**FLA460 LED**

Description	Part ID	A	C1	D x L1	Weight (kg)	D	D x S
TA4-L Mounting bracket, quad (Ø 89 x 200)	147-0213	±9°	690	108 x 200	26		108 x 200



TA1 Mounting bracket, single (Ø 108 x 200)	147-0096		130	108 x 200	7.50		108 x 200
--	----------	--	-----	-----------	------	--	-----------

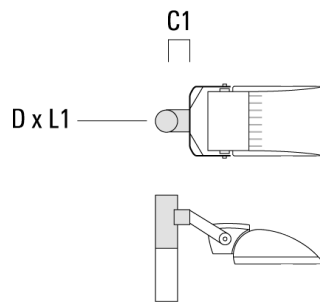

**FLA460 LED**

Description	Part ID	A	C1	D × L1	Weight (kg)	D	D × S
TA1 Mounting bracket, single* (Ø 76 x 200)	147-0023		130	76 x 200	1.90		76 x 200



**Floodlight mounting bracket KA**

Description	Part ID	D1	Weight (kg)	D
KA1-76 Pole bracket, single	310-9126	76 x 100	3.40	76 x 100



**FLA460 LED**

Description	Part ID	D1	Weight (kg)	D
KA2-76 Pole bracket, double	310-9127	76 x 100	3.40	76 x 100



**Pole clamp TS**

Description	Part ID	Additional information	D1	Weight (kg)	D
TS1-2/M12 Pole clamp, single (Ø 76-89)	147-0547		76-89	1.50	76-89



**FLA460 LED**

Description	Part ID	Additional information	D1	Weight (kg)	D
TS1-2/M12 Pole clamp, single (Ø 114-133)	147-0548		114-133	1.80	114-133



TS1-2/M12 Pole clamp, double (Ø 114-140)	147-0674	Pole clamps made from die-cast aluminium with stainless steel hardware. For mounting of one or two floodlights. Max. permissible weight per installed floodlight 22.5 kg.	114-140	1.70	
--	----------	---	---------	------	--

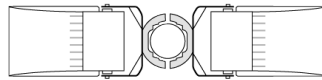

**FLA460 LED**

Description	Part ID	Additional information	D1	Weight (kg)	D
TS1-2/M12 Pole clamp, single (Ø 114-140)	147-0643		114-140	1.70	

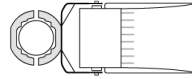

D1

**Short post EM**

Description	Part ID	D1	D2	H1	M1	Weight (kg)
EM1-M16	270-9038	160	130	200	9	2.10



**FLA460 LED**

**Planted root**

Description	Part ID	D1	D2	D3	D4	H1	H2	M1	T1	T2	Weight (kg)
Planted root ESV4	300-0461-AP	150	130	60	89	400	350	8	200	50 x 100	3.85

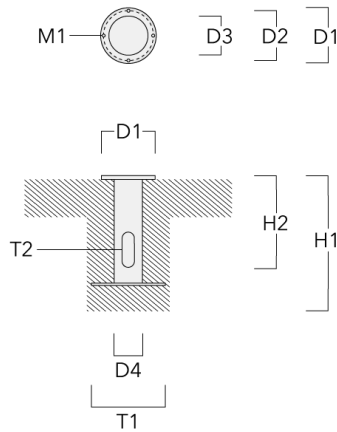

**Pipe clamp SP**

Description	Part ID	D1	Weight (kg)	D
SP1-M16 Pole clamp, single (Ø 38-60)	146-0241	38-60	1.30	38-60



**FLA460 LED**

Description	Part ID	D1	Weight (kg)	D
SP1-M16 Pole clamp, single (Ø 76-89)	146-0242	76-89	1.30	76-89

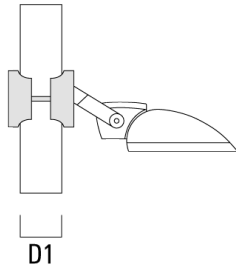

SP2-M16 Pole clamp, double (Ø 38-60)	146-0243	38-60	1.60	38-60
--------------------------------------	----------	-------	------	-------



**FLA460 LED**

Description	Part ID	D1	Weight (kg)	D
SP2-M16 Pole clamp, double (Ø 76-89)	146-0244	76-89	1.50	76-89



**Junction box JB1**

Description	Part ID	D1	D2	M1	Weight (kg)
JB1-M16-WE Junction box	310-9001	135	67	9	1.30

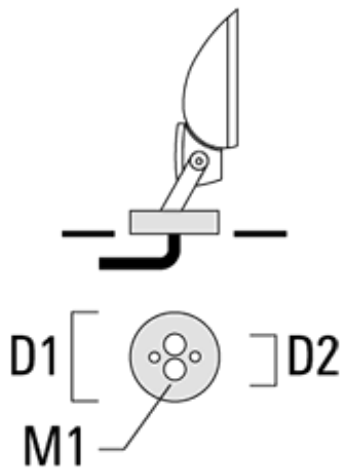

## Optical Accessories

### Light shield

Description	Part ID	Additional information
LS180-[A60]	003-4018	Glare Shield for backlight spill. Glare Shield factory-installed or available as retrofit kit. Suitable for [A60] lenses. Must be specified at time of ordering.
LS180	003-4019	Glare Shield for backlight spill. Glare Shield factory-installed or available as retrofit kit. Suitable for [S60], [S65], [S70], [R65], [P65] lenses. Must be specified at time of ordering.