

## FLC121 LED RAIL66



### Description

IP66, Class I. IK07. Marine-grade, die-cast aluminium alloy. 5CE superior corrosion protection + primer including PCS hardware. Safety glass lens. Silicone CCG® Controlled Compression Gasket. Luminaire is factory-sealed and does not need to be opened during installation. Integral EC electronic converter in thermally-separated compartment. Advanced thermal management protects LEDs while optimising lumens output. CAD-optimised optics for superior illumination and glare control. OLC® One LED Concept. Including 0.4 m of flexible cable enclosed in a stainless conduit, in-line connector and mounting clamp for installation to RAIL66 mounting system.

If ordering a fitting to be installed on an existing rail, please confirm the rail version with your local distributor or our customer excellence team as connectors vary.

|                           |                             |
|---------------------------|-----------------------------|
| Weight                    | 2.50 kg                     |
| Light distribution        | wallwash [A20]              |
| Light source              | LED-6/12W / 700 mA - 4000 K |
| CRI                       | 80                          |
| Power supply              | EC                          |
| LEDs                      | 6                           |
| Rated input power         | 14.5 W                      |
| <b>Nominal Lumen (lm)</b> |                             |
| LED Lumen                 | 310                         |
| Total Lumen               | 1860                        |
| Tj                        | 85                          |
| <b>Rated lumens (lm)</b>  |                             |
| LED Lumen                 | 216.1                       |
| Total Lumen               | 1296.6                      |
| Ta                        | 25                          |

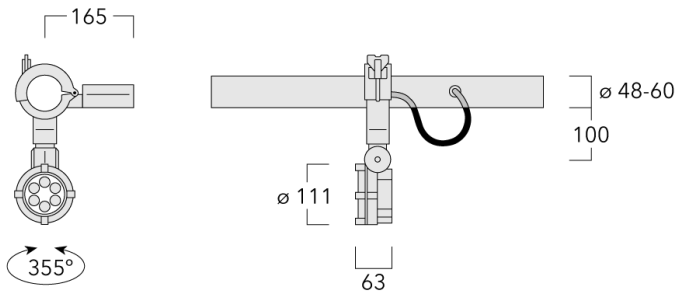

## Specifications

### Material description

|                      |  |
|----------------------|--|
| Body                 | Marine-grade die-cast aluminium alloy  |
| Lens                 | Safety glass lens  |
| Colours              | <div style="display: flex; align-items: center;"> <div style="width: 20px; height: 15px; background-color: black; margin-right: 5px;"></div> <span>RAL9004 Signal black</span> </div> <div style="display: flex; align-items: center; margin-top: 5px;"> <div style="width: 20px; height: 15px; background-color: #cccccc; margin-right: 5px;"></div> <span>RAL9006 White aluminium</span> </div> <div style="display: flex; align-items: center; margin-top: 5px;"> <div style="width: 20px; height: 15px; background-color: #808080; margin-right: 5px;"></div> <span>RAL9007 Grey aluminium</span> </div> |
| Gasket               | Silicone CCG® Controlled Compression Gasket  |
| Fasteners            | PCS Polymer Coated Stainless Steel Hardware (unpainted)  |
| Ingress protection   | IP66   |
| Impact resistance    | IK07   |
| Corrosion resistance | 5CE+Primer   |

### Electrical description

|                  |   |
|------------------|---|
| Power supply     | 230V / 50 Hz  |
| Driver / Ballast | Integral EC electronic converter in thermally-separated compartment |

### Additional information

|          |  |
|----------|--|
| Lifetime | Ta=40° L90B10 > 90000h   |
| Warranty | The product is supplied with 10-year warranty. Please refer to the LED Warranty Statement located on <a href="http://www.we-ef.com">www.we-ef.com</a> for further details. |

### Optical Accessories

#### Snoot

---

| Description | Part ID  | A  | C1  |
|-------------|----------|----|-----|
| Snoot ET    | 145-0030 | 60 | 120 |

---



---

#### Linear spread lens

---

| Description       | Part ID  | C1 |
|-------------------|----------|----|
| IO-180-FLC121-LED | 145-0050 | 81 |

---



**FLC121 LED RAIL66**

**Surface wash lens**

---

| Description       | Part ID  | C1 |
|-------------------|----------|----|
| IO-360-FLC121-LED | 145-9390 | 81 |

---

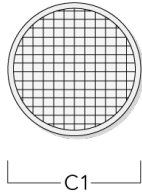

---

**Honeycomb louvre**

---

| Description   | Part ID  | C1 |
|---------------|----------|----|
| IW-FLC121-LED | 145-0143 | 81 |

---

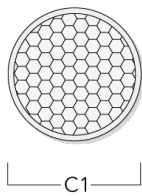

**FLC121 LED RAIL66**

**Wallwash lens**

| Description         | Part ID  | C1 |
|---------------------|----------|----|
| IO-20-WW-FLC121-LED | 145-0145 | 81 |



**Glare shield**

| Description     | Part ID  | A   | C1  |
|-----------------|----------|-----|-----|
| Glare shield ES | 145-9192 | 102 | 119 |



145-0044+145-0145

**we-ef**

FLC121 LED RAIL66

**Linear louvre**

---

| Description      | Part ID  | C1 |
|------------------|----------|----|
| Linear louvre IL | 145-9171 | 81 |

---



**Mounting Accessories**

**Universal**

| Description              | Part ID  | C1 | C2 | H1  | M1 | Weight (kg) | L1   | L2   |
|--------------------------|----------|----|----|-----|----|-------------|------|------|
| 2 Mains outlets (L=1150) | 310-9200 | 75 | 30 | 200 | 12 | 5.90        | 1150 | 1045 |

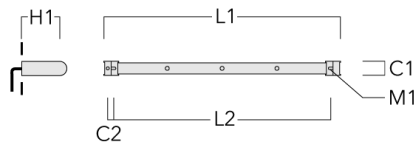

|                          |          |    |    |     |    |      |      |      |
|--------------------------|----------|----|----|-----|----|------|------|------|
| 3 Mains outlets (L=1150) | 310-9202 | 75 | 30 | 200 | 12 | 5.90 | 1150 | 1045 |
|--------------------------|----------|----|----|-----|----|------|------|------|

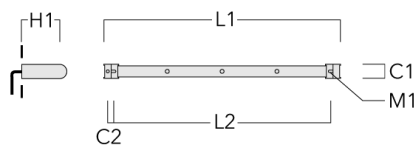

**FLC121 LED RAIL66**

| Description              | Part ID  | C1 | C2 | H1  | M1 | Weight (kg) | L1   | L2   |
|--------------------------|----------|----|----|-----|----|-------------|------|------|
| 3 Mains outlets (L=1650) | 310-9210 | 75 | 30 | 200 | 12 | 7.20        | 1650 | 1545 |



|                          |          |    |    |     |    |      |      |      |
|--------------------------|----------|----|----|-----|----|------|------|------|
| 4 Mains outlets (L=1650) | 310-9212 | 75 | 30 | 200 | 12 | 7.20 | 1650 | 1545 |
|--------------------------|----------|----|----|-----|----|------|------|------|





**FLC121 LED RAIL66**

| Description              | Part ID  | C1 | C2 | H1  | M1 | Weight (kg) | L1   | L2   |
|--------------------------|----------|----|----|-----|----|-------------|------|------|
| 4 Mains outlets (L=2150) | 310-9220 | 75 | 30 | 200 | 12 | 8.50        | 2150 | 2045 |

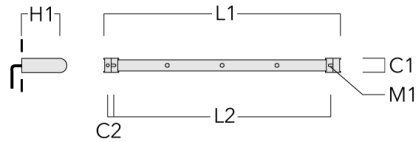

|                          |          |    |    |     |    |      |      |      |
|--------------------------|----------|----|----|-----|----|------|------|------|
| 6 Mains outlets (L=2150) | 310-9222 | 75 | 30 | 200 | 12 | 8.50 | 2150 | 2045 |
|--------------------------|----------|----|----|-----|----|------|------|------|

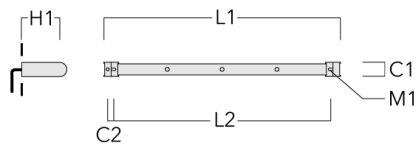

**FLC121 LED RAIL66**

**Flat Surface Fitters**

| Description            | Part ID  | C1 | C2 | D1  | D2  | L    | M1 | Weight (kg) |
|------------------------|----------|----|----|-----|-----|------|----|-------------|
| Surface fitters (pair) | 310-9290 | 20 | 30 | 180 | 140 | 1070 | 9  | 1.70        |

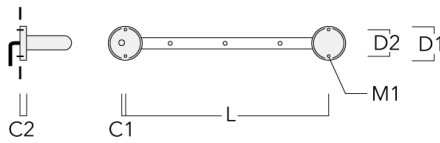

**Column Fitters**

| Description           | Part ID  | C1 | C2  | L    | M1 | Weight (kg) |
|-----------------------|----------|----|-----|------|----|-------------|
| Column fitters (pair) | 310-9294 | 30 | 100 | 1115 | 12 | 0.90        |

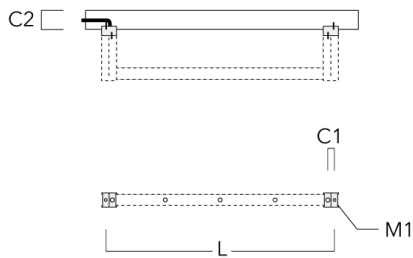

**FLC121 LED RAIL66**

**Cantilever**

| Description              | Part ID  | C1  | C2  | C3 | H1  | M1 | Weight (kg) | L1   | L2   |
|--------------------------|----------|-----|-----|----|-----|----|-------------|------|------|
| 2 Mains outlets (L=1150) | 310-9230 | 220 | 120 | 60 | 600 | 13 | 12          | 1150 | 1070 |

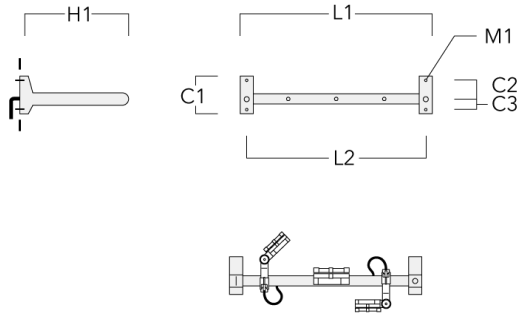

|                          |          |     |     |    |     |    |    |      |      |
|--------------------------|----------|-----|-----|----|-----|----|----|------|------|
| 3 Mains outlets (L=1150) | 310-9232 | 220 | 120 | 60 | 600 | 13 | 12 | 1150 | 1070 |
|--------------------------|----------|-----|-----|----|-----|----|----|------|------|

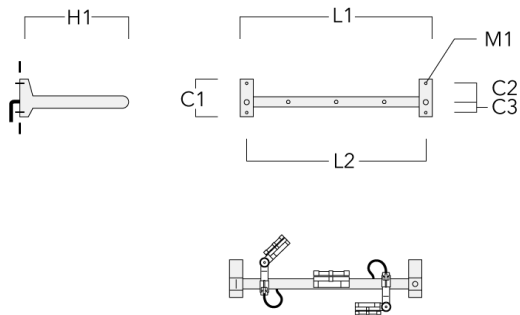

**FLC121 LED RAIL66**

| Description              | Part ID  | C1  | C2  | C3 | H1  | M1 | Weight (kg) | L1   | L2   |
|--------------------------|----------|-----|-----|----|-----|----|-------------|------|------|
| 3 Mains outlets (L=1650) | 310-9240 | 220 | 120 | 60 | 600 | 13 | 13.30       | 1650 | 1570 |

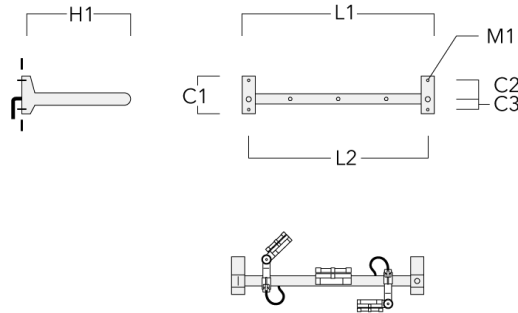

|                          |          |     |     |    |     |    |       |      |      |
|--------------------------|----------|-----|-----|----|-----|----|-------|------|------|
| 4 Mains outlets (L=1650) | 310-9242 | 220 | 120 | 60 | 600 | 13 | 13.30 | 1650 | 1570 |
|--------------------------|----------|-----|-----|----|-----|----|-------|------|------|

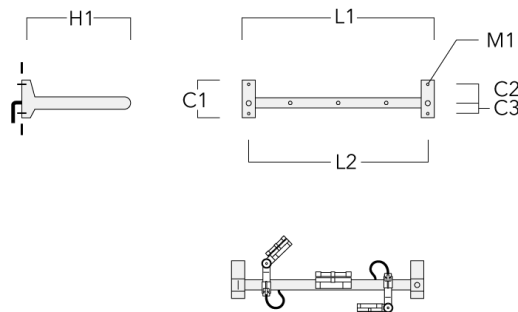

**FLC121 LED RAIL66**

| Description              | Part ID  | C1  | C2  | C3 | H1  | M1 | Weight (kg) | L1   | L2   |
|--------------------------|----------|-----|-----|----|-----|----|-------------|------|------|
| 4 Mains outlets (L=2150) | 310-9250 | 220 | 120 | 60 | 600 | 13 | 14.60       | 2150 | 2070 |

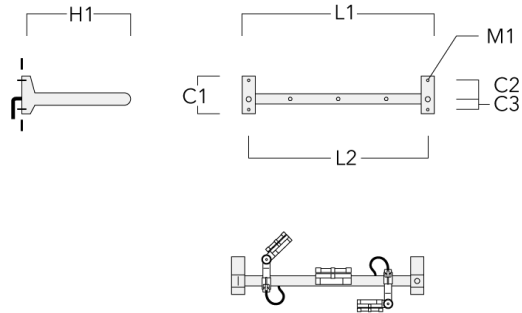

|                          |          |     |     |    |     |    |       |      |      |
|--------------------------|----------|-----|-----|----|-----|----|-------|------|------|
| 6 Mains outlets (L=2150) | 310-9252 | 220 | 120 | 60 | 600 | 13 | 14.60 | 2150 | 2070 |
|--------------------------|----------|-----|-----|----|-----|----|-------|------|------|

