

FLC121 LED POST



Description

IP66. Class I. IK07. Marine-grade, die-cast aluminum alloy. 5CE superior corrosion protection including PCS hardware. Silicone CCG® Controlled Compression Gasket. Safety glass lens. CAD-optimized optics for superior illumination and glare control. Integral driver in thermally separated compartment. OLC® One LED Concept. Factory-installed LED circuit board. 0-10V Dimming comes standard with luminaire. Luminaire is factory-sealed and does not need to be opened during installation.

Knuckle permits 350° horizontal and 90° vertical aiming of optics.

Specify product with 7 Digit product code - Finish Color. Accessories, such as mounting, optical, and electrical, must be specified separately.

Example: XXX-XXXX-9004 (Black)
+ XXX-XXXX (Accessory 1)

Weight	3.70 lb
Light distribution	wallwash
Light source	LED-6/12W / 700 mA - 3000 K
CRI	80
Power supply	electronic gear
LEDs	6
Rated input power	14.5 W

Nominal Lumen (lm)

LED Lumen	290
Total Lumen	1740
Tj	85

Rated lumens (lm)

LED Lumen	202.2
Total Lumen	1213
Ta	25

WE-EF LIGHTING USA, LLC

410-D Keystone Drive, 15086 Warrendale, PA 15086 - Phone: +1 724 742 0030
customersupport.usa@we-ef.com - <https://we-ef.com/us>
Subject to technical changes and errors. - Generated on 11/23/2024

FLC121 LED POST

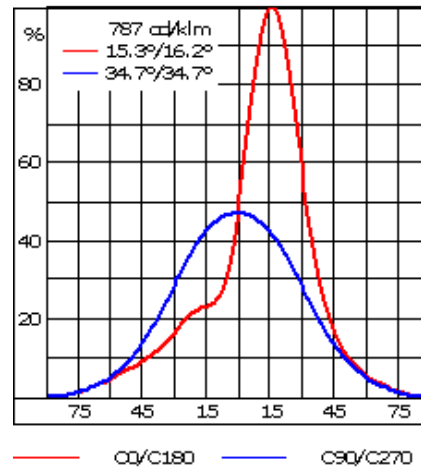
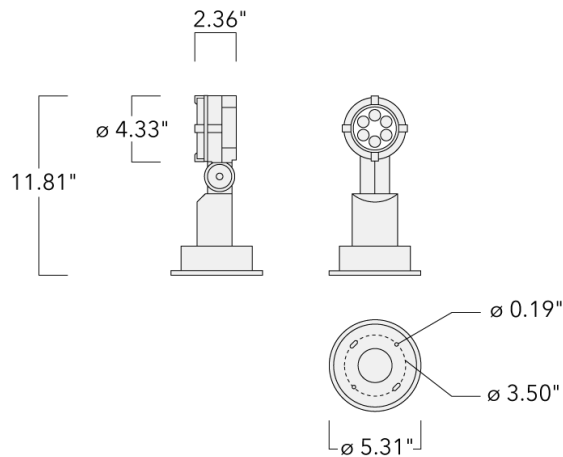

Specifications

Material description

Body	Marine-grade, die-cast aluminium alloy
Lens	Safety glass lens
Colors	<div style="display: flex; flex-direction: column; gap: 5px;"> <div> RAL9004 Black</div> <div> RAL9007 Grey Metallic</div> <div> RAL9016 White</div> <div> RAL8019 Dark Bronze</div> </div>
Gasket	Silicone rubber gasket
Fasteners	PCS polymer coated stainless steel
Ingress protection	IP66
Impact resistance	IK07
Corrosion resistance	5CE
Windage	0.025 m ²

Electrical description

Power supply	Integral [ECG] electronic 0-10 V dimmable driver in 120-277 universal voltage
Driver / Ballast	Integral EC electronic converter in thermally-separated compartment
Surge protection	Integral 10kV Surge Protector

WE-EF LIGHTING USA, LLC

410-D Keystone Drive, 15086 Warrendale, PA 15086 - Phone: +1 724 742 0030
 customersupport.usa@we-ef.com - <https://we-ef.com/us>
 Subject to technical changes and errors. - Generated on 11/23/2024

145-0031+145-0145

we-ef

FLC121 LED POST

Additional information

Lifetime	Ta=25°/40° L90B10 > 90000h
Other Color Temperatures	2700K, 3500K, 5000K and True Amber available on request.
Listings	ETL, UL-1598, CSA-C22.2#250.0. Suitable for Wet Locations.

WE-EF LIGHTING USA, LLC

410-D Keystone Drive, 15086 Warrendale, PA 15086 - Phone: +1 724 742 0030
customersupport.usa@we-ef.com - <https://we-ef.com/us>
Subject to technical changes and errors. - Generated on 11/23/2024

Optical Accessories

Snoot

Description	Part ID	A	C1
Snoot ET	145-0030	2.36"	4.72"

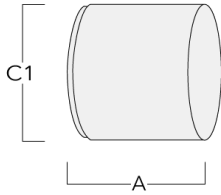

FLC121 LED POST

Linear spread lens

Description	Part ID	C1
IO-180-FLC121-LED	145-0050	3.19"

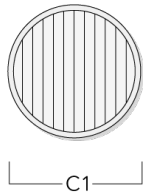

Softening Lens

Description	Part ID	C1
IO-360-FLC121-LED	145-0142	3.20

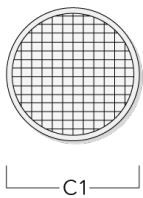

WE-EF LIGHTING USA, LLC

410-D Keystone Drive, 15086 Warrendale, PA 15086 - Phone: +1 724 742 0030
customersupport.usa@we-ef.com - <https://we-ef.com/us>
Subject to technical changes and errors. - Generated on 11/23/2024

FLC121 LED POST

Honeycomb louvre

Description	Part ID	C1
IW-FLC121-LED	145-0143	3.20

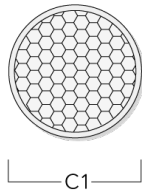

Wallwash lens

Description	Part ID	C1
IO-20-WW-FLC121-LED	145-0145	3.19"

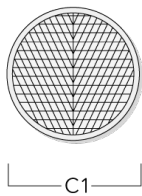

WE-EF LIGHTING USA, LLC

410-D Keystone Drive, 15086 Warrendale, PA 15086 - Phone: +1 724 742 0030
customersupport.usa@we-ef.com - <https://we-ef.com/us>
Subject to technical changes and errors. - Generated on 11/23/2024

FLC121 LED POST

Glare shield

Description	Part ID	A	C1
Glare shield ES	145-9192	4.02	4.69

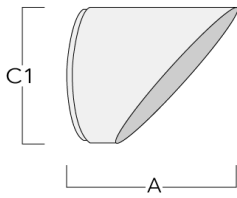

FLC121 LED POST

Mounting Accessories

Pipe clamp SP

Description	Part ID	D1	M1	Weight (lb)	D
SP1-2/M8 Pipe clamp, single (Ø 3"-3.5")	146-0246	3-3.5		1.20	76-89

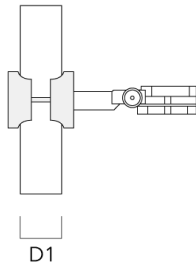

SP2-2/M8 Pipe clamp, double (Ø 1.5"-2.36")	146-0247	1.50"-2.36"	.35	2.20 lbs	38-66
--	----------	-------------	-----	----------	-------

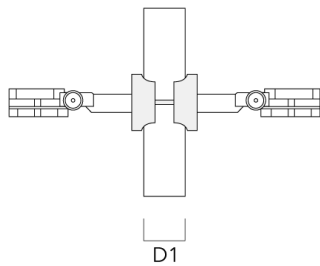

WE-EF LIGHTING USA, LLC

410-D Keystone Drive, 15086 Warrendale, PA 15086 - Phone: +1 724 742 0030
customersupport.usa@we-ef.com - <https://we-ef.com/us>

Subject to technical changes and errors. - Generated on 11/23/2024

FLC121 LED POST

Description	Part ID	D1	M1	Weight (lb)	D
SP2-2/M8 Pipe clamp, double (Ø 3"-3.5")	146-0248	3.0"-3.5"		2.65 lbs	76-89

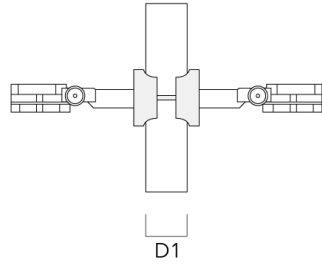

SP1-2/M8 Pipe clamp, single (Ø 1.5"-2.36")	146-0245	38-60	1	38-66
--	----------	-------	---	-------

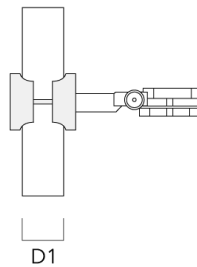

WE-EF LIGHTING USA, LLC

410-D Keystone Drive, 15086 Warrendale, PA 15086 - Phone: +1 724 742 0030
customersupport.usa@we-ef.com - <https://we-ef.com/us>
Subject to technical changes and errors. - Generated on 11/23/2024

FLC121 LED POST

Short post EM

Description	Part ID	D1	D2	H1	M1	Weight (lb)
EM1-2/M8	146-0253	6.3	5.12	7.87	0.35	3.00

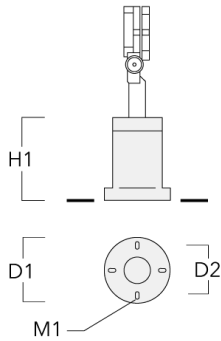

Planted root

Description	Part ID	D1	D2	D3	D4	H1	H2	M1	Weight (lb)
Planted root ESV4	300-0461	5.71	5.12	4.01	4.25	15.75	13.78	.31	15.50

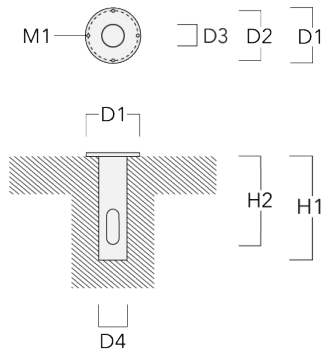

WE-EF LIGHTING USA, LLC

410-D Keystone Drive, 15086 Warrendale, PA 15086 - Phone: +1 724 742 0030

customersupport.usa@we-ef.com - <https://we-ef.com/us>

Subject to technical changes and errors. - Generated on 11/23/2024

FLC121 LED POST

Junction box JB1

Description	Part ID	D1	D2	M1	Weight (lb)
JB1 Junction box	310-9000	5.31	2.64	0.35	3.53

