

FLC131 LED Surface mounted

**Description**

IP66, Class I. IK07. Marine-grade, die-cast aluminium alloy. 5CE superior corrosion protection including PCS hardware. Safety glass lens. Silicone CCG® Controlled Compression Gasket.

Integral EC electronic converter in thermally-separated compartment. Advanced thermal management protects LEDs while optimising lumens output. CAD-optimised optics for superior illumination and glare control. OLC® One LED Concept. Optional 2200 K version available. To be specified at time of ordering.

Weight	2.50 kg
Light distribution	wallwash
Light source	LED-12/24W / 700 mA - 3000 K
CRI	80
Power supply	EC
LEDs	12
Rated input power	27 W

Nominal Lumen (lm)

LED Lumen	290
Total Lumen	3480
Tj	85

Rated lumens (lm)

LED Lumen	200.5
Total Lumen	2405.6
Ta	25

FLC131 LED Surface mounted

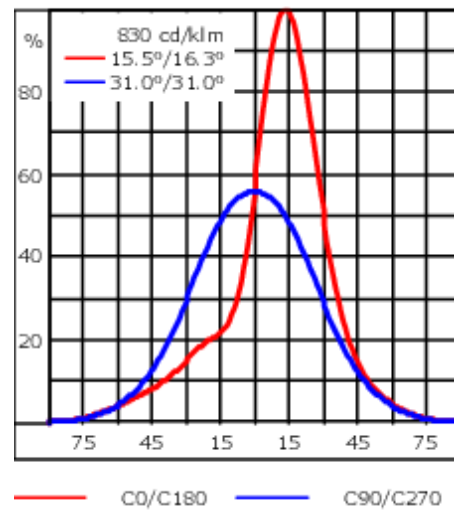
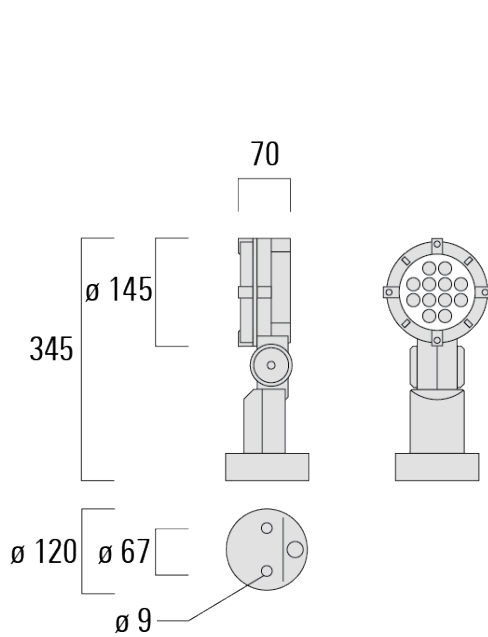

Specifications

Material description

Body	Marine-grade, die-cast aluminium alloy
Lens	Safety glass lens
Colours	<div style="display: flex; align-items: center; gap: 10px;"> <div style="width: 20px; height: 15px; background-color: black; margin-right: 5px;"></div> RAL9004 Signal black </div> <div style="display: flex; align-items: center; gap: 10px; margin-top: 5px;"> <div style="width: 20px; height: 15px; background-color: #808080; margin-right: 5px;"></div> RAL9007 Grey aluminium </div> <div style="display: flex; align-items: center; gap: 10px; margin-top: 5px;"> <div style="width: 20px; height: 15px; background-color: #333333; margin-right: 5px;"></div> RAL7016 Anthracite grey </div> <div style="display: flex; align-items: center; gap: 10px; margin-top: 5px;"> <div style="width: 20px; height: 15px; background-color: #e0e0e0; margin-right: 5px;"></div> RAL9016 Traffic white </div>
Gasket	Silicone CCG® Controlled Compression Gasket
Fasteners	PCS hardware
Ingress protection	IP66
Impact resistance	IK07
Corrosion resistance	5CE
Windage	0.041 m ²

Electrical description

Power supply	220-240V / 50-60 Hz
Driver / Ballast	Integral EC electronic converter in thermally-separated compartment

WE-EF LIGHTING (Thailand) Co., Ltd.

57 Moo 5, Kingkaew Rd., Bangplee, 10540 Samutprakarn - Phone: +66 2 738 96 20 - Fax: +66 2 738 96 29

<https://we-ef.com/asia>

Subject to technical changes and errors. - Generated on 23/11/2024

146-0399+146-0645

we-ef

FLC131 LED Surface mounted

Additional information

Lifetime	Ta=25° L90B10 > 90000h
----------	------------------------

WE-EF LIGHTING (Thailand) Co., Ltd.

57 Moo 5, Kingkaew Rd., Bangplee, 10540 Samutprakarn - Phone: +66 2 738 96 20 - Fax: +66 2 738 96 29

<https://we-ef.com/asia>

Subject to technical changes and errors. - Generated on 23/11/2024

Optical Accessories

Glare shield

Description	Part ID	A	C1
Glare shield ES	146-0156	110	100



Snoot

Description	Part ID	A	C1
Snoot ET	146-0397	95,5	126



FLC131 LED Surface mounted

Flood lens

Description	Part ID	C1
Flood lens IO-360	146-0419	110



Linear louvre

Description	Part ID	C1
Linear louvre IL	146-9055	110



FLC131 LED Surface mounted

Linear spread lens

Description	Part ID	C1
Linear spread lens IO-180	146-0418	110

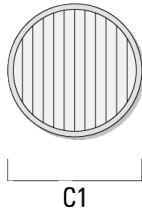

Wallwash lens

Description	Part ID	C1
Wallwash lens IO-20	146-0645	110

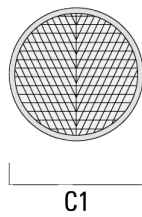

146-0399+146-0645

we-ef

FLC131 LED Surface mounted

Honeycomb louvre

Description	Part ID	C1
Honeycomb louvre IW	146-0625	110



Colour correction filter

Description	Part ID
IF-3000K > 2400K	146-9054



WE-EF LIGHTING (Thailand) Co., Ltd.

57 Moo 5, Kingkaew Rd., Bangplee, 10540 Samutprakarn - Phone: +66 2 738 96 20 - Fax: +66 2 738 96 29

<https://we-ef.com/asia>

Subject to technical changes and errors. - Generated on 23/11/2024

Mounting Accessories

Pole clamp

Description	Part ID	D1	Weight (kg)	D
Pole clamp SP1-2/M8, single (Ø 76-89)	146-0246	76-89	1.20	76-89



Pole clamp SP2-2/M8, double (Ø 38-60)	146-0247	38-60	1	38-66
---------------------------------------	----------	-------	---	-------



FLC131 LED Surface mounted

Description	Part ID	D1	Weight (kg)	D
Pole clamp SP2-2/M8, double (Ø 76-89)	146-0248	76-89	1.20	76-89



Pole clamp SP1-2/M8, single (Ø 38-60)	146-0245	38-60	1	38-66
---------------------------------------	----------	-------	---	-------

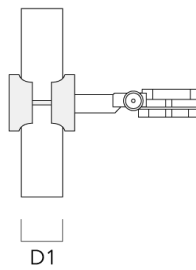

FLC131 LED Surface mounted

Short post

Description	Part ID	D1	D2	H1	M1	Weight (kg)
Short post EM1-2/M8	146-0253	160	130	200	9	1.10



Planted root

Description	Part ID	D1	D2	D3	D4	H1	H2	M1	T1	T2	Weight (kg)
Planted root ESV4	300-0461-AP	150	130	60	89	400	350	8	200	50 x 100	3.85

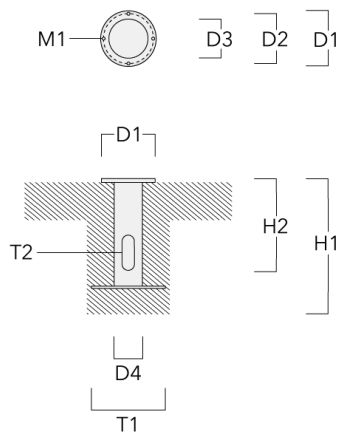

FLC131 LED Surface mounted

Ground spike

Description	Part ID	H1	Weight (kg)
Ground spike EF1 (including cable and plug)	146-0251	270	0.40



Ground spike EF1 (without cable and plug)	146-0250	270	0.40
-------------------------------------------	----------	-----	------

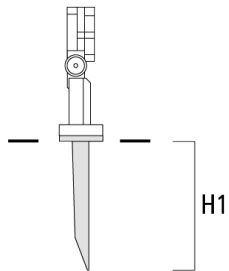

146-0399+146-0645

we-ef

FLC131 LED Surface mounted

Junction box

Description	Part ID	D1	D2	M1	Weight (kg)
Junction box JB1	310-9000	135	67	9	1.6

