



Description

IP66, Class I. Class II on request. IK08. Marine-grade die-cast aluminium alloy. 5CE superior corrosion protection including PCS hardware. Silicone CCG® Controlled Compression Gasket. Safety glass lens, hinged. Integral EC electronic converter. DALI. CAD- optimised OLC® PMMA lens. Integrated surge protection 6/6kV.

Optional 2200 K version available. To be specified at time of ordering.

Weight	9.90 kg
Light distribution	asymmetric, side throw beam [S65]
Light source	LED-18/36W / 700 mA - 3000 K
CRI	80
Power supply	EC
LEDs	18
Rated input power	41 W
Nominal Lumen (lm)	
LED Lumen	290
Total Lumen	5220
Tj	85
Rated lumens (lm)	
LED Lumen	232.4
Total Lumen	4182.7
Ta	25



Specifications

Material description

Body	Marine-grade, die-cast aluminium alloy
Lens	Safety glass lens, hinged
Colours	<div style="display: flex; align-items: center; margin-bottom: 5px;"> <div style="width: 20px; height: 15px; background-color: black; margin-right: 5px;"></div> RAL9004 Signal black </div> <div style="display: flex; align-items: center; margin-bottom: 5px;"> <div style="width: 20px; height: 15px; background-color: #cccccc; margin-right: 5px;"></div> RAL9006 White aluminium </div> <div style="display: flex; align-items: center; margin-bottom: 5px;"> <div style="width: 20px; height: 15px; background-color: #808080; margin-right: 5px;"></div> RAL9007 Grey aluminium </div> <div style="display: flex; align-items: center; margin-bottom: 5px;"> <div style="width: 20px; height: 15px; background-color: #333333; margin-right: 5px;"></div> RAL7016 Anthracite grey </div> <div style="display: flex; align-items: center;"> <div style="width: 20px; height: 15px; background-color: #e0e0e0; margin-right: 5px;"></div> RAL9016 Traffic white </div>
Gasket	Silicone CCG® Controlled Compression Gasket
Fasteners	PCS Polymer Coated Stainless Steel Hardware
Ingress protection	IP66
Impact resistance	IK08
Corrosion resistance	5CE
Windage	0.098 m ²

Electrical description

Power supply	220-240V / 50-60 Hz
Driver / Ballast	Integral EC electronic converter. DALI
Power factor	> 0.9
Surge protection	6/6 kV (optional SP10)

WE-EF LEUCHTEN GmbH

Töpinger Straße 16, 29646 Bispingen, Germany - Phone: +49 5194 909-0

info@we-ef.com - <https://we-ef.com>

Subject to technical changes and errors. - Generated on 23/10/2024

107-0081

EFL540 LED

we-ef

Additional information

Lifetime Ta=25° L90B10 > 90000h

Energy efficiency class C-D (Light source)

WE-EF LEUCHTEN GmbH

Töpinger Straße 16, 29646 Bispingen, Germany - Phone: +49 5194 909-0
info@we-ef.com - <https://we-ef.com>

Subject to technical changes and errors. - Generated on 23/10/2024

107-0081

EFL540 LED

we-ef

Control

Eco Step Dim® Basic

Description	Part ID
Eco Step Dim® Basic LED	430-0001

Eco Step Dim® Advanced

Description	Part ID
Eco Step Dim® Advanced LED	430-0002

WE-EF LEUCHTEN GmbH

Töpinger Straße 16, 29646 Bispingen, Germany - Phone: +49 5194 909-0

info@we-ef.com - <https://we-ef.com>

Subject to technical changes and errors. - Generated on 23/10/2024

Mounting Accessories

Wall and pole brackets RE

Description	Part ID	C1	D1	D2	D × L1	H1	M1	Weight (kg)	C	H
RE0-540 Wall bracket	111-0084	180	230	195			12	3.20	140	

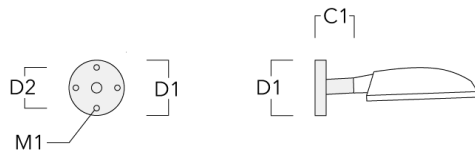

RE1-540 Pole bracket, single	111-0042	200			76 x 130	550		4.60	200	550
------------------------------	----------	-----	--	--	----------	-----	--	------	-----	-----

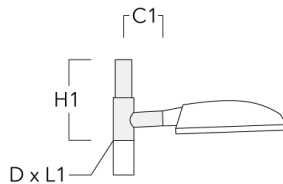

Description	Part ID	C1	D1	D2	D × L1	H1	M1	Weight (kg)	C	H
RE2-540 Pole bracket, double	111-0043	200			76 x 130	550		5.30	200	550

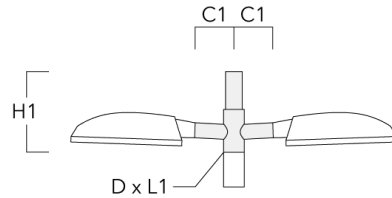

Wall and pole brackets RV

Description	Part ID	Additional information	C1	C2	C3	D1	D × L1	H1	H2	M1	M2	Weight (kg)	C	D	H
RV0 Wall bracket	108-0979	RV0 Wall bracket	108	100	60			200	160	38	12	2.00	108		

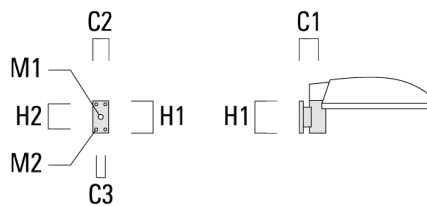

107-0081

EFL540 LED

we-ef

Description	Part ID	Additional information	C1	C2	C3	D1	D x L1	H1	H2	M1	M2	Weight (kg)	C	D	H
RV2-76 Pole bracket, double	108-0980	147					76 x 100					4.80	147	76	200



RV2-60 Pole bracket, double	108-0981	147					60 x 100					4.80	147	60	200
-----------------------------	----------	-----	--	--	--	--	----------	--	--	--	--	------	-----	----	-----



WE-EF LEUCHTEN GmbH

Töpinger Straße 16, 29646 Bispingen, Germany - Phone: +49 5194 909-0

info@we-ef.com - <https://we-ef.com>

Subject to technical changes and errors. - Generated on 23/10/2024

Description	Part ID	Additional information	C1	C2	C3	D1	D × L1	H1	H2	M1	M2	Weight (kg)	C	D	H
RV5 Pole bracket	108-0982	108				76-240						1.70	106		200

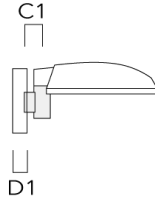

Pole brackets RF

Description	Part ID	C1	D × L1	H1	Weight (kg)	C	H
RF1-540 Pole bracket, single	111-0046	200	76 x 80	200	2.60	200	300



Description	Part ID	C1	D × L1	H1	Weight (kg)	C	H
RF2-540 Pole bracket, double	111-0047	200	76 x 80	200	3.30	200	300



Tilt brackets TB

Description	Part ID	A	D1	D2	L	Weight (kg)
TB-540.60-10 Tilt bracket 10°	111-0636	10°	60 x 90	60 x 100	205	0.70



107-0081

EFL540 LED

we-ef

Description	Part ID	A	D1	D2	L	Weight (kg)
TB-540.60-15 Tilt bracket 15°	111-0637	15°	60 x 90	60 x 100	205	0.70



Post top fitter AKV

Description	Part ID	C1	D × L1	D × L2	H1	Weight (kg)
AKV2-76	300-0053	180	76x100	67x	235	1.50

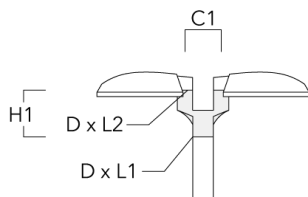

WE-EF LEUCHTEN GmbH

Töpinger Straße 16, 29646 Bispingen, Germany - Phone: +49 5194 909-0

info@we-ef.com - <https://we-ef.com>

Subject to technical changes and errors. - Generated on 23/10/2024

107-0081

EFL540 LED

we-ef

Optical Accessories

Light shield

Description	Part ID	Additional information
LS180	430-0029	Glare Shield for backlight spill. Glare Shield factory-installed or available as retrofit kit. Suitable for [S60], [S65], [S70], [R65], [P65] lenses. Must be specified at time of ordering.

107-0081

EFL540 LED

WE-EF LEUCHTEN GmbH

Töpinger Straße 16, 29646 Bispingen, Germany

Phone: +49 5194 909-0

info@we-ef.com

<https://we-ef.com>

Subject to technical changes and errors.

Generated on 23/10/2024