

107-0084

EFL540 LED

we-ef



Description

IP66, Class I. Class II on request. IK08. Marine-grade die-cast aluminium alloy. 5CE superior corrosion protection including PCS hardware. Silicone CCG® Controlled Compression Gasket. Safety glass lens, hinged. Integral EC electronic converter. DALI. CAD- optimised OLC® PMMA lens. Integrated surge protection 6/6kV.

Optional 2200 K version available. To be specified at time of ordering.

| | |
|--------------------|-----------------------------------|
| Weight | 9.90 kg |
| Light distribution | asymmetric, side throw beam [S65] |
| Light source | LED-18/54W / 1050 mA - 3000 K |
| CRI | 80 |
| Power supply | EC |
| LEDs | 18 |
| Rated input power | 59 W |

Nominal Lumen (lm)

| | |
|-------------|------|
| LED Lumen | 430 |
| Total Lumen | 7740 |
| Tj | 85 |

Rated lumens (lm)

| | |
|-------------|-------|
| LED Lumen | 344.6 |
| Total Lumen | 6202 |
| Ta | 25 |

Fagerhult Lighting Ltd

33-34 Dolben Street, SE1 0UQ London, United Kingdom

<https://we-ef.com/uk>

Subject to technical changes and errors. - Generated on 19/04/2025

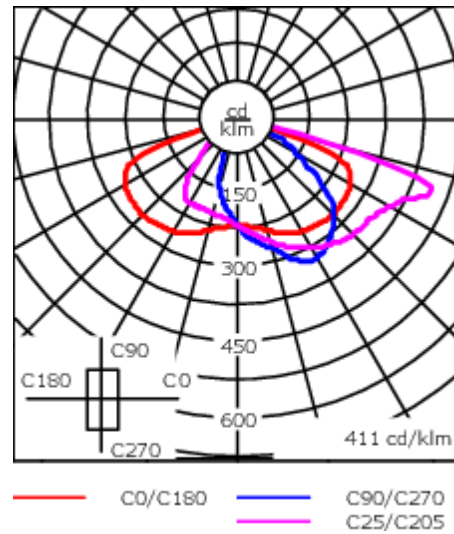
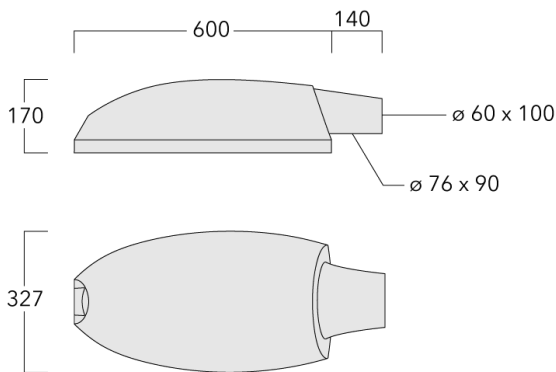

Specifications

Material description

| | |
|----------------------|------------------------------------------------------------------------------------------------------------------------------------------------------------------------------------------------------------------------------------------------------------------------------------------------------------------------------------------------------------------------------------------------------------------------------------------------------------------------------------------------------------------------------------------------------------------------------------------------------------------------------------------------------------------------------------------------------------------------------------------------------------------------------------------------------------------------------------------------------------------------------------------------------------------------------------------------------------------------------------------------------------------------------------|
| Body | Marine-grade, die-cast aluminium alloy |
| Lens | Safety glass lens, hinged |
| Colours | <div style="display: flex; align-items: center;"> <div style="width: 20px; height: 15px; background-color: black; margin-right: 5px;"></div> RAL9004 Signal black </div> <div style="display: flex; align-items: center; margin-top: 5px;"> <div style="width: 20px; height: 15px; background-color: #cccccc; margin-right: 5px;"></div> RAL9006 White aluminium </div> <div style="display: flex; align-items: center; margin-top: 5px;"> <div style="width: 20px; height: 15px; background-color: #808080; margin-right: 5px;"></div> RAL9007 Grey aluminium </div> <div style="display: flex; align-items: center; margin-top: 5px;"> <div style="width: 20px; height: 15px; background-color: #333333; margin-right: 5px;"></div> RAL7016 Anthracite grey </div> <div style="display: flex; align-items: center; margin-top: 5px;"> <div style="width: 20px; height: 15px; background-color: #e0e0e0; margin-right: 5px;"></div> RAL9016 Traffic white </div> |
| Gasket | Silicone CCG® Controlled Compression Gasket |
| Fasteners | PCS Polymer Coated Stainless Steel Hardware |
| Ingress protection | IP66 |
| Impact resistance | IK08 |
| Corrosion resistance | 5CE |
| Windage | 0.098 m ² |

Electrical description

| | |
|------------------|----------------------------------------|
| Power supply | 220-240V / 50-60 Hz |
| Driver / Ballast | Integral EC electronic converter. DALI |
| Power factor | > 0.9 |
| Surge protection | 6/6 kV (optional SP10) |

107-0084

EFL540 LED

we-ef

Additional information

Lifetime Ta=25° L90B10 > 90000h

Energy efficiency class C-D (Light source)

Fagerhult Lighting Ltd

33-34 Dolben Street, SE1 0UQ London, United Kingdom

<https://we-ef.com/uk>

Subject to technical changes and errors. - Generated on 19/04/2025

107-0084

EFL540 LED

we-ef

Control

Eco Step Dim® Basic

| Description | Part ID |
|-------------------------|----------|
| Eco Step Dim® Basic LED | 430-0001 |

Eco Step Dim® Advanced

| Description | Part ID |
|----------------------------|----------|
| Eco Step Dim® Advanced LED | 430-0002 |

Fagerhult Lighting Ltd

33-34 Dolben Street, SE1 0UQ London, United Kingdom

<https://we-ef.com/uk>

Subject to technical changes and errors. - Generated on 19/04/2025

Mounting Accessories

Wall and pole brackets RE

| Description | Part ID | C1 | D1 | D2 | D × L1 | H1 | M1 | Weight (kg) | C | H |
|----------------------|----------|-----|-----|-----|--------|----|----|-------------|-----|---|
| RE0-540 Wall bracket | 111-0084 | 180 | 230 | 195 | | | 12 | 3.20 | 140 | |

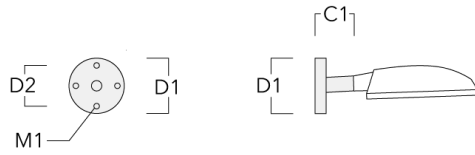

| | | | | | | | | | | |
|------------------------------|----------|-----|--|--|----------|-----|--|------|-----|-----|
| RE1-540 Pole bracket, single | 111-0042 | 200 | | | 76 x 130 | 550 | | 4.60 | 200 | 550 |
|------------------------------|----------|-----|--|--|----------|-----|--|------|-----|-----|

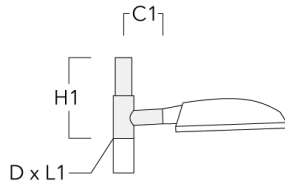

| Description | Part ID | C1 | D1 | D2 | D × L1 | H1 | M1 | Weight (kg) | C | H |
|------------------------------|----------|-----|----|----|----------|-----|----|-------------|-----|-----|
| RE2-540 Pole bracket, double | 111-0043 | 200 | | | 76 x 130 | 550 | | 5.30 | 200 | 550 |

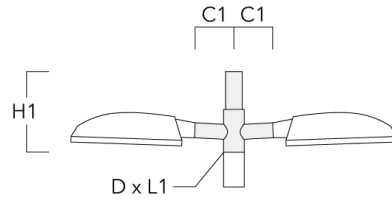

Wall and pole brackets RV

| Description | Part ID | Additional information | C1 | C2 | C3 | D1 | D × L1 | H1 | H2 | M1 | M2 | Weight (kg) | C | D | H |
|------------------|----------|------------------------|-----|-----|----|----|--------|-----|-----|----|----|-------------|-----|---|---|
| RV0 Wall bracket | 108-0979 | RV0 Wall bracket | 108 | 100 | 60 | | | 200 | 160 | 38 | 12 | 2.00 | 108 | | |

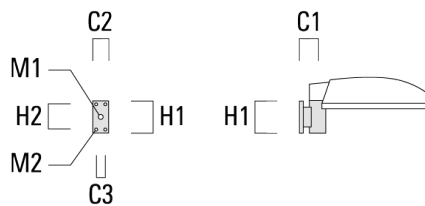

EFL540 LED

| Description | Part ID | Additional information | C1 | C2 | C3 | D1 | D x L1 | H1 | H2 | M1 | M2 | Weight (kg) | C | D | H |
|-----------------------------|----------|------------------------|----|----|----|----|----------|----|----|----|----|-------------|-----|----|-----|
| RV2-76 Pole bracket, double | 108-0980 | 147 | | | | | 76 x 100 | | | | | 4.80 | 147 | 76 | 200 |

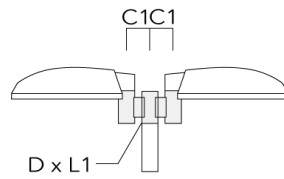

| | | | | | | | | | | | | | | | |
|-----------------------------|----------|-----|--|--|--|--|----------|--|--|--|--|------|-----|----|-----|
| RV2-60 Pole bracket, double | 108-0981 | 147 | | | | | 60 x 100 | | | | | 4.80 | 147 | 60 | 200 |
|-----------------------------|----------|-----|--|--|--|--|----------|--|--|--|--|------|-----|----|-----|

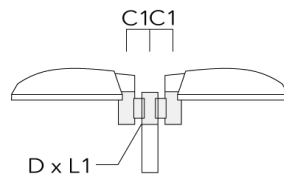

| Description | Part ID | Additional information | C1 | C2 | C3 | D1 | D × L1 | H1 | H2 | M1 | M2 | Weight (kg) | C | D | H |
|------------------|----------|------------------------|----|----|----|--------|--------|----|----|----|----|-------------|-----|---|-----|
| RV5 Pole bracket | 108-0982 | 108 | | | | 76-240 | | | | | | 1.70 | 106 | | 200 |

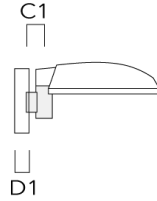

Pole brackets RF

| Description | Part ID | C1 | D × L1 | H1 | Weight (kg) | C | H |
|------------------------------|----------|-----|---------|-----|-------------|-----|-----|
| RF1-540 Pole bracket, single | 111-0046 | 200 | 76 x 80 | 200 | 2.60 | 200 | 300 |

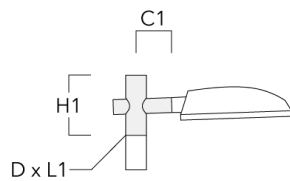

| Description | Part ID | C1 | D × L1 | H1 | Weight (kg) | C | H |
|------------------------------|----------|-----|---------|-----|-------------|-----|-----|
| RF2-540 Pole bracket, double | 111-0047 | 200 | 76 x 80 | 200 | 3.30 | 200 | 300 |

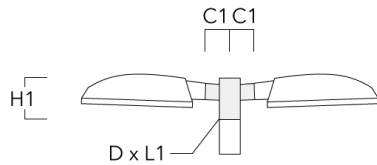

Tilt brackets TB

| Description | Part ID | A | D1 | D2 | L | Weight (kg) |
|-------------------------------|----------|-----|---------|----------|-----|-------------|
| TB-540.60-10 Tilt bracket 10° | 111-0636 | 10° | 60 x 90 | 60 x 100 | 205 | 0.70 |

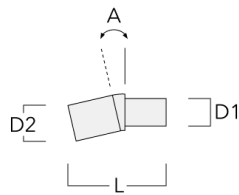

107-0084

EFL540 LED

we-ef

| Description | Part ID | A | D1 | D2 | L | Weight (kg) |
|-------------------------------|----------|-----|---------|----------|-----|-------------|
| TB-540.60-15 Tilt bracket 15° | 111-0637 | 15° | 60 x 90 | 60 x 100 | 205 | 0.70 |

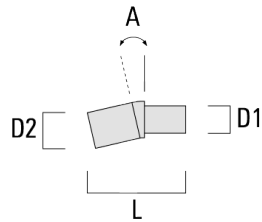

Post top fitter AKV

| Description | Part ID | C1 | D × L1 | D × L2 | H1 | Weight (kg) |
|-------------|----------|-----|--------|--------|-----|-------------|
| AKV2-76 | 300-0053 | 180 | 76x100 | 67x | 235 | 1.50 |

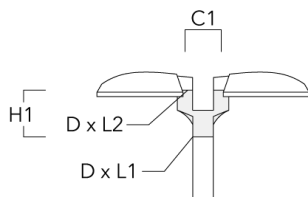

Fagerhult Lighting Ltd

33-34 Dolben Street, SE1 0UQ London, United Kingdom

<https://we-ef.com/uk>

Subject to technical changes and errors. - Generated on 19/04/2025

107-0084

EFL540 LED

we-ef

Optical Accessories

Light shield

| Description | Part ID | Additional information |
|-------------|----------|----------------------------------------------------------------------------------------------------------------------------------------------------------------------------------------------|
| LS180 | 430-0029 | Glare Shield for backlight spill. Glare Shield factory-installed or available as retrofit kit. Suitable for [S60], [S65], [S70], [R65], [P65] lenses. Must be specified at time of ordering. |