

FLC141 LED Surface mounted

**Description**

IP66, Class I. IK07. Marine-grade, die-cast aluminium alloy. 5CE superior corrosion protection including PCS hardware. Safety glass lens. Silicone CCG® Controlled Compression Gasket.

Integral EC electronic converter in thermally-separated compartment. Advanced thermal management protects LEDs while optimising lumens output. CAD-optimised optics for superior illumination and glare control. OLC® One LED Concept. Optional 2200 K version available. To be specified at time of ordering.

Weight	4.40 kg
Light distribution	linear spread, very narrow beam [EE]
Light source	LED-24/48W / 700 mA - 4000 K
CRI	80
Power supply	EC
LEDs	24
Rated input power	54 W
Nominal Lumen (lm)	
LED Lumen	310
Total Lumen	7440
T _j	85
Rated lumens (lm)	
LED Lumen	247
Total Lumen	5927.6
T _a	25

FLC141 LED Surface mounted

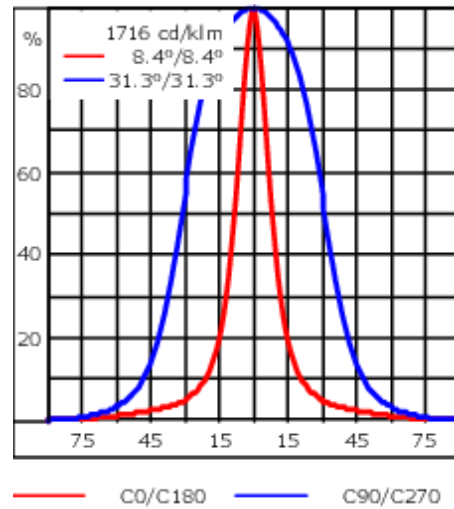
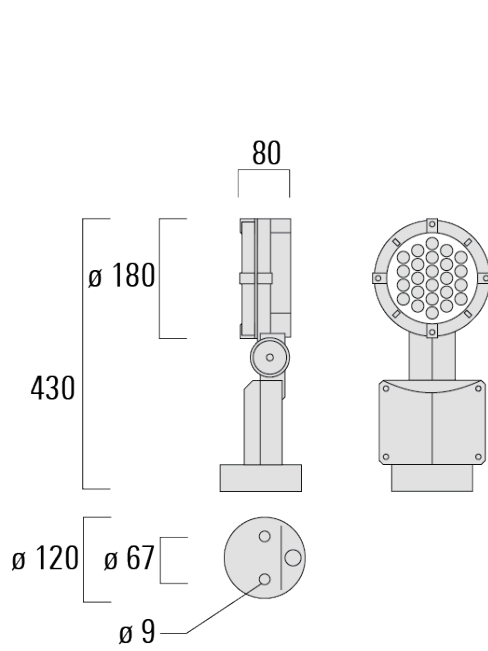

Specifications

Material description

Body	Marine-grade, die-cast aluminium alloy
Lens	Safety glass lens
Colours	<div style="display: flex; align-items: center;"> <div style="width: 20px; height: 15px; background-color: black; margin-right: 5px;"></div> RAL9004 Signal black </div> <div style="display: flex; align-items: center; margin-top: 5px;"> <div style="width: 20px; height: 15px; background-color: #808080; margin-right: 5px;"></div> RAL9007 Grey aluminium </div> <div style="display: flex; align-items: center; margin-top: 5px;"> <div style="width: 20px; height: 15px; background-color: #404040; margin-right: 5px;"></div> RAL7016 Anthracite grey </div> <div style="display: flex; align-items: center; margin-top: 5px;"> <div style="width: 20px; height: 15px; background-color: #e0e0e0; margin-right: 5px;"></div> RAL9016 Traffic white </div>
Gasket	Silicone CCG® Controlled Compression Gasket
Fasteners	PCS hardware
Ingress protection	IP66
Impact resistance	IK07
Corrosion resistance	5CE
Windage	0.057 m ²

Electrical description

Power supply	220-240V / 50-60 Hz
Driver / Ballast	Integral EC electronic converter in thermally-separated compartment

146-7065+146-0439

we-ef

FLC141 LED Surface mounted

Additional information

Lifetime	Ta=25° L90B10 > 90000h
----------	------------------------

WE-EF LIGHTING (Thailand) Co., Ltd.

57 Moo 5, Kingkaew Rd., Bangplee, 10540 Samutprakarn - Phone: +66 2 738 96 20 - Fax: +66 2 738 96 29

<https://we-ef.com/asia>

Subject to technical changes and errors. - Generated on 23/11/2024

Optical Accessories

Glare shield

Description	Part ID	A	C1
Glare shield ES	146-0229	120	145



Snoot

Description	Part ID	A	C1
Snoot ET	146-0398	120	145

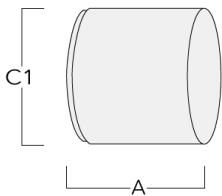

FLC141 LED Surface mounted

Linear louvre

Description	Part ID	C1
Linear louvre IL	146-9056	145



Honeycomb louvre

Description	Part ID	C1
Honeycomb louvre IW	146-0626	145

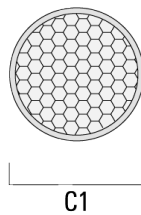

146-7065+146-0439

we-ef

FLC141 LED Surface mounted

Colour correction filter

Description	Part ID
IF-3000K > 2400K	146-9058

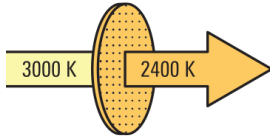

WE-EF LIGHTING (Thailand) Co., Ltd.

57 Moo 5, Kingkaew Rd., Bangplee, 10540 Samutprakarn - Phone: +66 2 738 96 20 - Fax: +66 2 738 96 29

<https://we-ef.com/asia>

Subject to technical changes and errors. - Generated on 23/11/2024

Mounting Accessories

Pole clamp

Description	Part ID	D1	Weight (kg)	D
Pole clamp SP1-2/M8, single (Ø 76-89)	146-0246	76-89	1.20	76-89



Pole clamp SP2-2/M8, double (Ø 38-60)	146-0247	38-60	1	38-66
---------------------------------------	----------	-------	---	-------



FLC141 LED Surface mounted

Description	Part ID	D1	Weight (kg)	D
Pole clamp SP2-2/M8, double (Ø 76-89)	146-0248	76-89	1.20	76-89



Pole clamp SP1-2/M8, single (Ø 38-60)	146-0245	38-60	1	38-66
---------------------------------------	----------	-------	---	-------



FLC141 LED Surface mounted

Short post

Description	Part ID	D1	D2	H1	M1	Weight (kg)
Short post EM1-2/M8	146-0253	160	130	200	9	1.10



Planted root

Description	Part ID	D1	D2	D3	D4	H1	H2	M1	T1	T2	Weight (kg)
Planted root ESV4	300-0461-AP	150	130	60	89	400	350	8	200	50 x 100	3.85

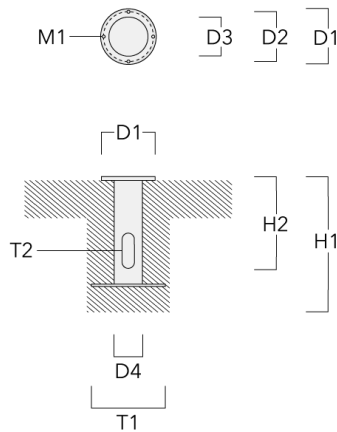

FLC141 LED Surface mounted

Ground spike

Description	Part ID	H1	Weight (kg)
Ground spike EF1 (including cable and plug)	146-0251	270	0.40

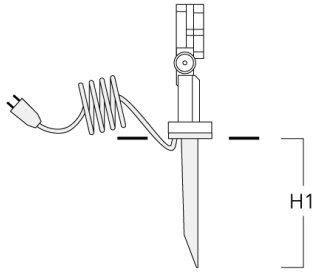

Ground spike EF1 (without cable and plug)	146-0250	270	0.40
---	----------	-----	------

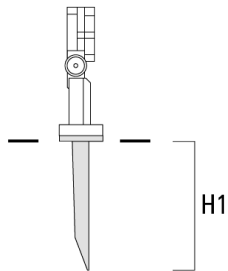

146-7065+146-0439

we-ef

FLC141 LED Surface mounted

Junction box

Description	Part ID	D1	D2	M1	Weight (kg)
Junction box JB1	310-9000	135	67	9	1.6

