



### Description

IP66, Class I. Class II on request. IK08. Marine-grade, die-cast aluminium alloy. 5CE superior corrosion protection including PCS hardware. Silicone CCG® Controlled Compression Gasket. Safety glass, hinged. Integral EC electronic converter. CAD-optimised optics for superior illumination and glare control. OLC® One LED Concept. Factory installed LED circuit board. Luminaire +/-30° tiltable.

Optional 2200 K version available. To be specified at time of ordering.

Weight	8.50 kg
Light distribution	asymmetric, side throw beam [S65]
Light source	LED-18/36W / 700 mA - 4000 K
CRI	80
Power supply	EC
LEDs	18
Rated input power	41 W

### Nominal Lumen (lm)

LED Lumen	310
Total Lumen	5580
Tj	85

### Rated lumens (lm)

LED Lumen	247.7
Total Lumen	4458.1
Ta	25

108-1748



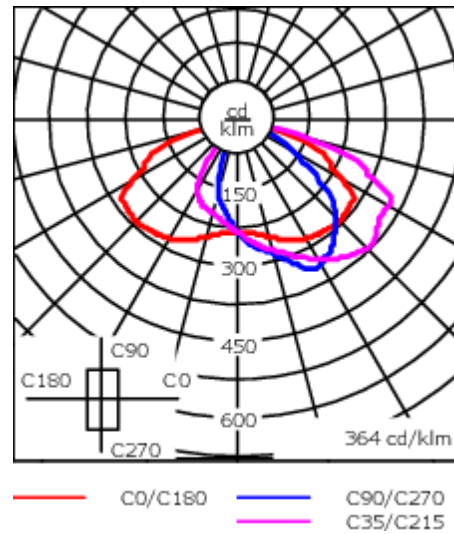
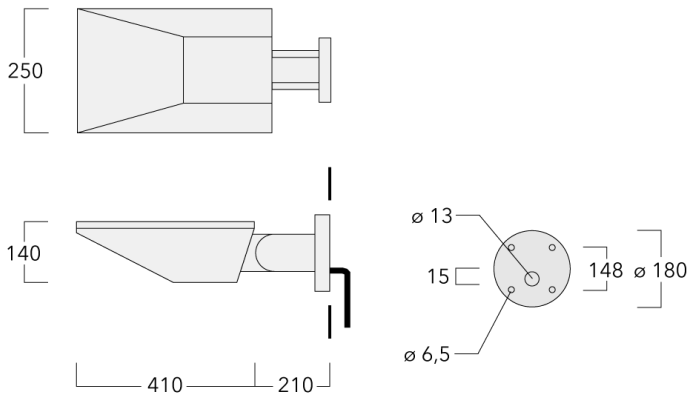

PIA230 LED

**we-ef**



## Specifications

### Material description

Body	Marine-grade die-cast aluminium alloy
Lens	Safety glass lens, hinged
Colours	 RAL9004 Signal black  RAL9006 White aluminium  RAL9007 Grey aluminium  RAL7016 Anthracite grey  RAL9016 Traffic white
Gasket	Silicone CCG® Controlled Compression Gasket
Fasteners	PCS Polymer Coated Stainless Steel Hardware
Ingress protection	IP66
Impact resistance	IK08
Corrosion resistance	5CE

### Electrical description

Power supply	220-240V / 50-60 Hz
Driver / Ballast	Integral EC electronic converter

### Additional information

Lifetime	Ta=25° L90B10 > 90000h
Energy efficiency class	C-D (Light source)

#### WE-EF LEUCHTEN GmbH

Töpinger Straße 16, 29646 Bispingen, Germany - Phone: +49 5194 909-0  
info@we-ef.com - <https://we-ef.com>

Subject to technical changes and errors. - Generated on 23/11/2024