

146-7056+146-0439

FLC141 LED - Wall bracket

we-ef



Description

IP55. Class I. IK07. Marine-grade, die-cast aluminum alloy. 5CE superior corrosion protection including PCS hardware. Silicone CCG® Controlled Compression Gasket. Safety glass lens. CAD-optimized optics for superior illumination and glare control. Integral driver in thermally separated compartment. OLC® One LED Concept. Factory-installed LED circuit board. 0-10V Dimming comes standard with luminaire.

Knuckle permits 350° horizontal and 90° vertical aiming of optics.

Specify product with 7 Digit product code - Finish Color. Accessories, such as mounting, optical, and electrical, must be specified separately.

Example: XXX-XXXX-9004 (Black)
+ XXX-XXXX (Accessory 1)

Weight	12.80 lb
Light distribution	linear spread, very narrow beam, 'sharp cut-off'
Light source	LED-24/48W / 700 mA - 3000 K
CRI	80
Power supply	electronic gear
LEDs	24
Rated input power	54 W
Nominal Lumen (lm)	
LED Lumen	290
Total Lumen	6960
Tj	85
Rated lumens (lm)	
LED Lumen	254.4
Total Lumen	6104.9
Ta	25

WE-EF LIGHTING USA, LLC

410-D Keystone Drive, 15086 Warrendale, PA 15086 - Phone: +1 724 742 0030
customersupport.usa@we-ef.com - <https://we-ef.com/us>
Subject to technical changes and errors. - Generated on 11/23/2024

146-7056+146-0439



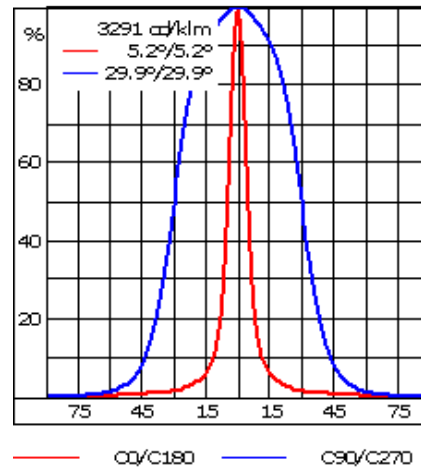
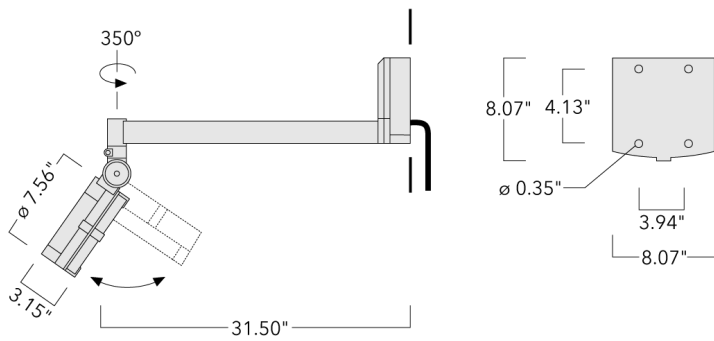

we-ef

FLC141 LED - Wall bracket



Specifications

Material description

Body	Marine-grade die-cast aluminium alloy
Lens	Clear tempered glass lens.
Colors	 RAL9004 Black  RAL9007 Grey Metallic  RAL9016 White  RAL8019 Dark Bronze
Gasket	Silicone rubber gasket
Fasteners	PCS Polymer Coated Stainless Steel hardware
Ingress protection	IP55
Impact resistance	IK07
Corrosion resistance	5CE

Electrical description

Power supply	Integral [ECG] electronic driver 120V-277V. 0-10V dimmable, to be specified with order.
Driver / Ballast	Integral EC electronic converter in thermally-separated compartment
Surge protection	Integral 10kV Surge Protector

Additional information

Lifetime	Ta=25°/40° L90B10 > 90000h
Listings	ETL, UL-1598, CSA-C22.2#250.0. Suitable for Wet Locations.

WE-EF LIGHTING USA, LLC

410-D Keystone Drive, 15086 Warrendale, PA 15086 - Phone: +1 724 742 0030
customersupport.usa@we-ef.com - <https://we-ef.com/us>
Subject to technical changes and errors. - Generated on 11/23/2024

146-7056+146-0439

we-ef

FLC141 LED - Wall bracket

Optical Accessories

Glare shield

Description	Part ID	A	C1
Glare shield ES	146-0229	4.72	5.71

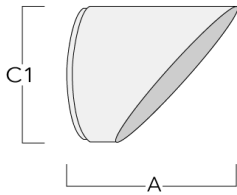

WE-EF LIGHTING USA, LLC

410-D Keystone Drive, 15086 Warrendale, PA 15086 - Phone: +1 724 742 0030
customersupport.usa@we-ef.com - <https://we-ef.com/us>

Subject to technical changes and errors. - Generated on 11/23/2024

FLC141 LED - Wall bracket

Snoot

Description	Part ID	A	C1
Snoot ET	146-0398	4.72	5.70

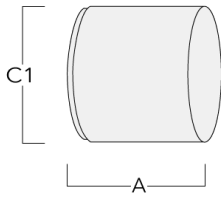

Honeycomb louvre

Description	Part ID	C1
IW-FLC141-LED	146-0626	5.70

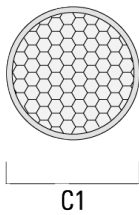

WE-EF LIGHTING USA, LLC

410-D Keystone Drive, 15086 Warrendale, PA 15086 - Phone: +1 724 742 0030
customersupport.usa@we-ef.com - <https://we-ef.com/us>
Subject to technical changes and errors. - Generated on 11/23/2024