

146-7057+146-0439

FLC141 LED - Wall bracket

we-ef



Description

IP55. Class I. IK07. Marine-grade, die-cast aluminum alloy. 5CE superior corrosion protection including PCS hardware. Silicone CCG® Controlled Compression Gasket. Safety glass lens. CAD-optimized optics for superior illumination and glare control. Integral driver in thermally separated compartment. OLC® One LED Concept. Factory-installed LED circuit board. 0-10V Dimming comes standard with luminaire.

Knuckle permits 350° horizontal and 90° vertical aiming of optics.

Specify product with 7 Digit product code - Finish Color. Accessories, such as mounting, optical, and electrical, must be specified separately.

Example: XXX-XXXX-9004 (Black)
+ XXX-XXXX (Accessory 1)

| | |
|--------------------|--|
| Weight | 12.80 lb |
| Light distribution | linear spread, very narrow beam, 'sharp cut-off' |
| Light source | LED-24/48W / 700 mA - 4000 K |
| CRI | 80 |
| Power supply | electronic gear |
| LEDs | 24 |
| Rated input power | 54 W |

Nominal Lumen (lm)

| | |
|-------------|------|
| LED Lumen | 310 |
| Total Lumen | 7440 |
| Tj | 85 |

Rated lumens (lm)

| | |
|-------------|-------|
| LED Lumen | 271.9 |
| Total Lumen | 6526 |
| Ta | 25 |

WE-EF LIGHTING USA, LLC

410-D Keystone Drive, 15086 Warrendale, PA 15086 - Phone: +1 724 742 0030
customersupport.usa@we-ef.com - <https://we-ef.com/us>
Subject to technical changes and errors. - Generated on 11/23/2024

146-7057+146-0439



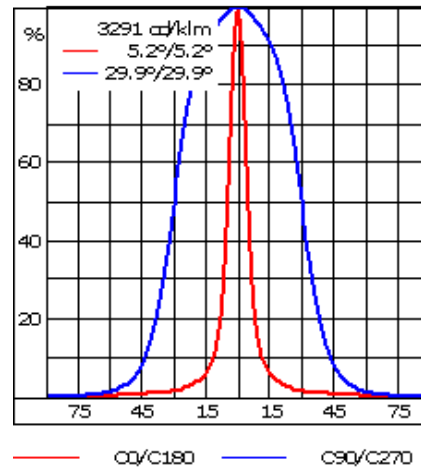
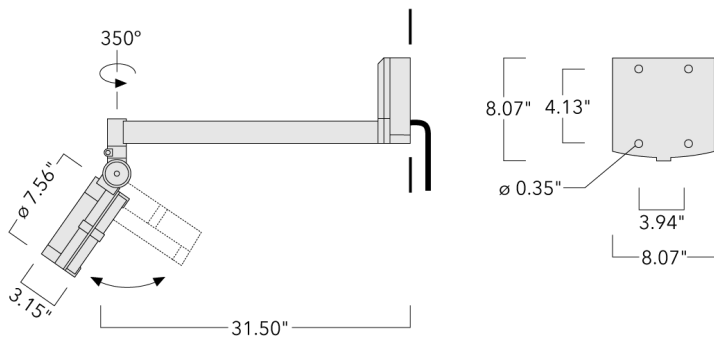

we-ef

FLC141 LED - Wall bracket



Specifications

Material description

| | |
|----------------------|---|
| Body | Marine-grade die-cast aluminium alloy |
| Lens | Clear tempered glass lens. |
| Colors |  RAL9004 Black  RAL9007 Grey Metallic  RAL9016 White  RAL8019 Dark Bronze |
| Gasket | Silicone rubber gasket |
| Fasteners | PCS Polymer Coated Stainless Steel hardware |
| Ingress protection | IP55 |
| Impact resistance | IK07 |
| Corrosion resistance | 5CE |

Electrical description

| | |
|------------------|---|
| Power supply | Integral [ECG] electronic driver 120V-277V. 0-10V dimmable, to be specified with order. |
| Driver / Ballast | Integral EC electronic converter in thermally-separated compartment |
| Surge protection | Integral 10kV Surge Protector |

Additional information

| | |
|----------|--|
| Lifetime | Ta=25°/40° L90B10 > 90000h |
| Listings | ETL, UL-1598, CSA-C22.2#250.0. Suitable for Wet Locations. |

WE-EF LIGHTING USA, LLC

410-D Keystone Drive, 15086 Warrendale, PA 15086 - Phone: +1 724 742 0030
customersupport.usa@we-ef.com - <https://we-ef.com/us>
Subject to technical changes and errors. - Generated on 11/23/2024

146-7057+146-0439

we-ef

FLC141 LED - Wall bracket

Optical Accessories

Glare shield

| Description | Part ID | A | C1 |
|-----------------|----------|------|------|
| Glare shield ES | 146-0229 | 4.72 | 5.71 |

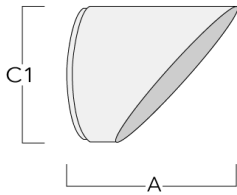

WE-EF LIGHTING USA, LLC

410-D Keystone Drive, 15086 Warrendale, PA 15086 - Phone: +1 724 742 0030
customersupport.usa@we-ef.com - <https://we-ef.com/us>

Subject to technical changes and errors. - Generated on 11/23/2024

FLC141 LED - Wall bracket

Snoot

| Description | Part ID | A | C1 |
|-------------|----------|------|------|
| Snoot ET | 146-0398 | 4.72 | 5.70 |

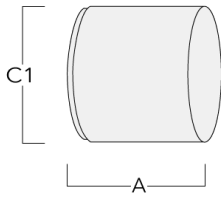

Honeycomb louvre

| Description | Part ID | C1 |
|---------------|----------|------|
| IW-FLC141-LED | 146-0626 | 5.70 |

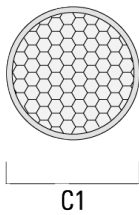

WE-EF LIGHTING USA, LLC

410-D Keystone Drive, 15086 Warrendale, PA 15086 - Phone: +1 724 742 0030
customersupport.usa@we-ef.com - <https://we-ef.com/us>
Subject to technical changes and errors. - Generated on 11/23/2024