

FLC141 LED RAIL66



Description

IP66. Class I. IK07. Marine-grade, die-cast aluminum alloy. 5CE superior corrosion protection including PCS hardware. Silicone CCG® Controlled Compression Gasket. Safety glass lens. Including 1 ft of flexible cable enclosed in a stainless conduit, in-line connector and mounting clamp for installation to RAIL66 mounting system. CAD-optimized optics for superior illumination and glare control. Integral driver in thermally separated compartment. OLC® One LED Concept. Factory-installed LED circuit board. 0-10V Dimming comes standard with luminaire.

Specify product with 7 Digit product code - Finish Color. Accessories, such as mounting, optical, and electrical, must be specified separately.

Example: XXX-XXXX-9004 (Black)
+ XXX-XXXX (Accessory 1)

Weight	10.40 lb
Light distribution	linear spread, very narrow beam [VN]
Light source	LED-24/48W / 700 mA - 3000 K
CRI	80
Power supply	electronic gear
LEDs	24
Rated input power	54 W
Nominal Lumen (lm)	
LED Lumen	290
Total Lumen	6960
Tj	85
Rated lumens (lm)	
LED Lumen	231
Total Lumen	5545.2
Ta	25

WE-EF LIGHTING USA, LLC

410-D Keystone Drive, 15086 Warrendale, PA 15086 - Phone: +1 724 742 0030
customersupport.usa@we-ef.com - <https://we-ef.com/us>
Subject to technical changes and errors. - Generated on 11/27/2024

FLC141 LED RAIL66

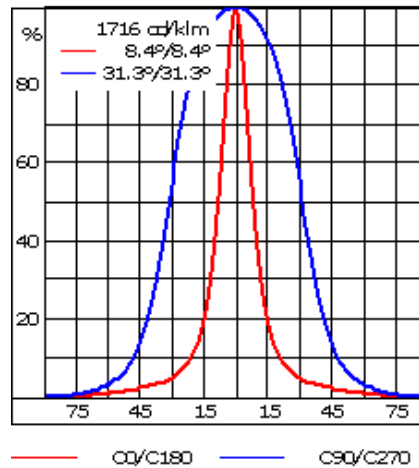
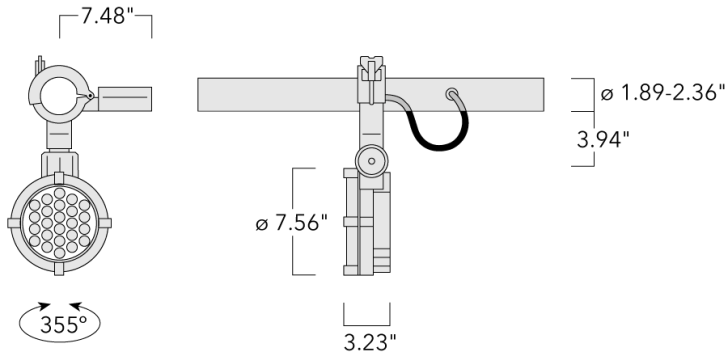

Specifications

Material description

Body	Marine-grade die-cast aluminium alloy
Lens	Clear tempered glass lens
Colors	<div style="display: flex; flex-direction: column; gap: 5px;"> <div> RAL9004 Black</div> <div> RAL9007 Grey Metallic</div> <div> RAL9016 White</div> <div> RAL8019 Dark Bronze</div> </div>
Gasket	Silicone CCG® Controlled Compression Gasket
Fasteners	PCS Polymer Coated Stainless Steel hardware
Ingress protection	IP66
Impact resistance	IK07
Corrosion resistance	5CE

Electrical description

Power supply	Integral [ECG] electronic driver 120V-277V. 0-10V dimmable, to be specified with order.
Driver / Ballast	Integral driver in thermally-separated compartment

WE-EF LIGHTING USA, LLC

410-D Keystone Drive, 15086 Warrendale, PA 15086 - Phone: +1 724 742 0030

customersupport.usa@we-ef.com - <https://we-ef.com/us>

Subject to technical changes and errors. - Generated on 11/27/2024

146-7072+146-0439

we-ef

FLC141 LED RAIL66

Additional information

Lifetime	Ta=25°/40° L90B10 > 90000h
Listings	ETL listed. Suitable for wet locations.

WE-EF LIGHTING USA, LLC

410-D Keystone Drive, 15086 Warrendale, PA 15086 - Phone: +1 724 742 0030
customersupport.usa@we-ef.com - <https://we-ef.com/us>
Subject to technical changes and errors. - Generated on 11/27/2024

Optical Accessories

Glare shield

Description	Part ID	A	C1
Glare shield ES	146-0229	4.72	5.71



FLC141 LED RAIL66

Snoot

Description	Part ID	A	C1
Snoot ET	146-0398	4.72	5.70

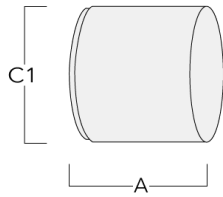

Honeycomb louvre

Description	Part ID	C1
IW-FLC141-LED	146-0626	5.70

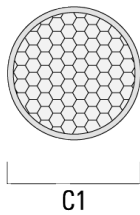

WE-EF LIGHTING USA, LLC

410-D Keystone Drive, 15086 Warrendale, PA 15086 - Phone: +1 724 742 0030
customersupport.usa@we-ef.com - <https://we-ef.com/us>
Subject to technical changes and errors. - Generated on 11/27/2024

FLC141 LED RAIL66

Mounting Accessories

Universal

Description	Part ID	C1	C2	H1	M1	Weight (lb)	L1	L2
2 Mains outlets (L=45.28)	310-9200	3.00	1.20	7.90	0.5	13.00	45.28	41.14

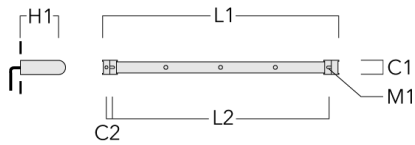

3 Mains outlets (L=45.28)	310-9202	3.00	1.20	7.90	0.5	13.00	45.28	41.14
---------------------------	----------	------	------	------	-----	-------	-------	-------

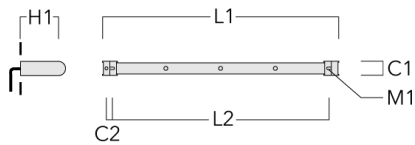

WE-EF LIGHTING USA, LLC

410-D Keystone Drive, 15086 Warrendale, PA 15086 - Phone: +1 724 742 0030
customersupport.usa@we-ef.com - <https://we-ef.com/us>

Subject to technical changes and errors. - Generated on 11/27/2024

FLC141 LED RAIL66

Description	Part ID	C1	C2	H1	M1	Weight (lb)	L1	L2
3 Mains outlets (L=64.69)	310-9210	3.00	1.18	7.90	0.5	15.90	64.69	60.83

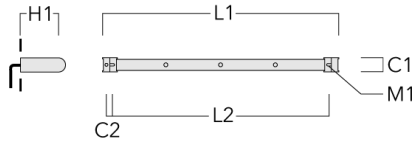

4 Mains outlets (L=64.69)	310-9212	3.00	1.18	7.90	5	13.00 lbs	64.69	60.83
---------------------------	----------	------	------	------	---	-----------	-------	-------

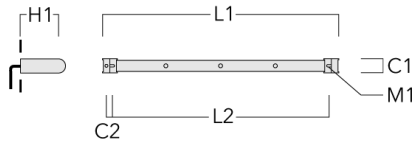

WE-EF LIGHTING USA, LLC

410-D Keystone Drive, 15086 Warrendale, PA 15086 - Phone: +1 724 742 0030

customersupport.usa@we-ef.com - <https://we-ef.com/us>

Subject to technical changes and errors. - Generated on 11/27/2024

FLC141 LED RAIL66

Description	Part ID	C1	C2	H1	M1	Weight (lb)	L1	L2
4 Mains outlets (L=84.65)	310-9220	3.00	1.18	7.90	0.5	18.76	84.65	80.51

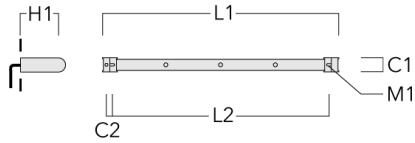

6 Mains outlets (L=84.65)	310-9222	3.00	1.18	7.90	0.5	18.76	84.65	80.51
---------------------------	----------	------	------	------	-----	-------	-------	-------

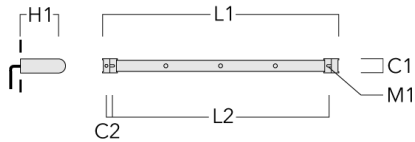

WE-EF LIGHTING USA, LLC

410-D Keystone Drive, 15086 Warrendale, PA 15086 - Phone: +1 724 742 0030
 customersupport.usa@we-ef.com - <https://we-ef.com/us>

Subject to technical changes and errors. - Generated on 11/27/2024

FLC141 LED RAIL66

Flat Surface Fitters

Description	Part ID	C1	C2	D1	D2	L	M1	Weight (lb)
Surface fitters (pair)	310-9290	0.79	1.18	7.1	5.5	42.1	.35	3.70

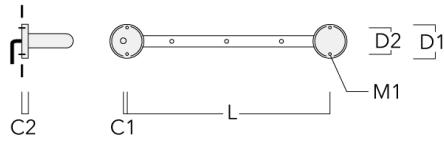

Cantilever

Description	Part ID	C1	C2	C3	H1	M1	Weight (lb)	L1	L2
2 Mains outlets (L=45.28)	310-9230	8.66	4.72	2.36	23.62	0.51	26.46	45.28	42.13

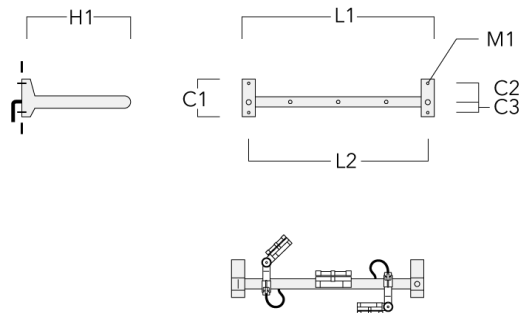

WE-EF LIGHTING USA, LLC

410-D Keystone Drive, 15086 Warrendale, PA 15086 - Phone: +1 724 742 0030

customersupport.usa@we-ef.com - <https://we-ef.com/us>

Subject to technical changes and errors. - Generated on 11/27/2024

FLC141 LED RAIL66

Description	Part ID	C1	C2	C3	H1	M1	Weight (lb)	L1	L2
3 Mains outlets (L=45.28)	310-9232	8.66	4.72	2.36	23.62	0.51	26.46	45.28	42.13

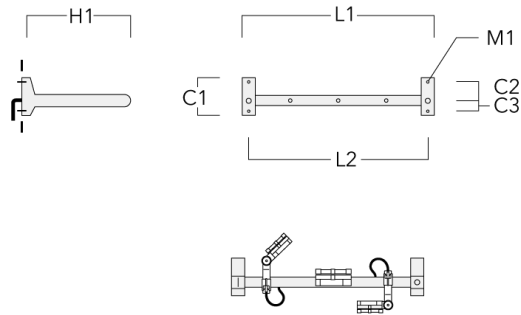

3 Mains outlets (L=64.69)	310-9240	8.66	4.72	2.36	23.62	0.51	29.32	64.96	61.81
---------------------------	----------	------	------	------	-------	------	-------	-------	-------

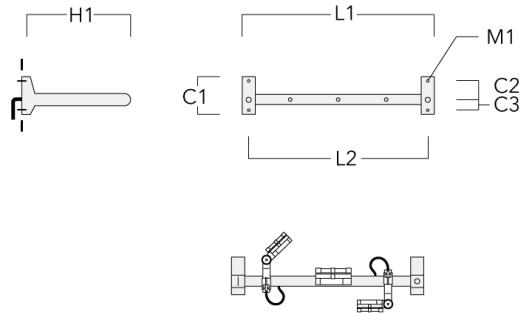

WE-EF LIGHTING USA, LLC

410-D Keystone Drive, 15086 Warrendale, PA 15086 - Phone: +1 724 742 0030
 customersupport.usa@we-ef.com - <https://we-ef.com/us>
 Subject to technical changes and errors. - Generated on 11/27/2024

FLC141 LED RAIL66

Description	Part ID	C1	C2	C3	H1	M1	Weight (lb)	L1	L2
4 Mains outlets (L=64.69)	310-9242	8.66	4.72	2.36	23.62	0.51	29.32	64.96	61.81

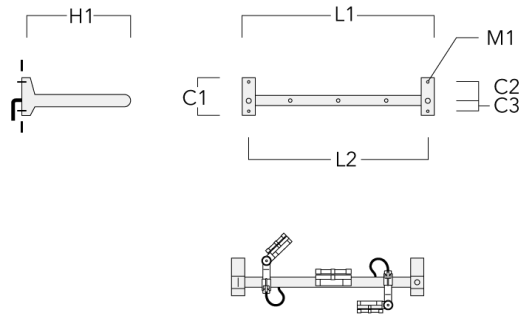

4 Mains outlets (L=84.65)	310-9250	8.66	4.72	2.36	23.62	0.51	32.19	84.65	81.49
---------------------------	----------	------	------	------	-------	------	-------	-------	-------

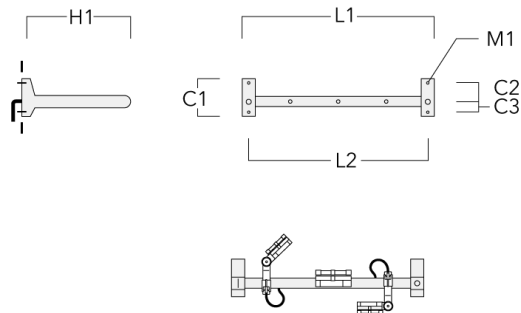

WE-EF LIGHTING USA, LLC

410-D Keystone Drive, 15086 Warrendale, PA 15086 - Phone: +1 724 742 0030
 customersupport.usa@we-ef.com - <https://we-ef.com/us>
 Subject to technical changes and errors. - Generated on 11/27/2024

FLC141 LED RAIL66

Description	Part ID	C1	C2	C3	H1	M1	Weight (lb)	L1	L2
6 Mains outlets (L=84.65)	310-9252	8.66	4.72	2.36	23.62	0.51	32.19	84.65	81.5

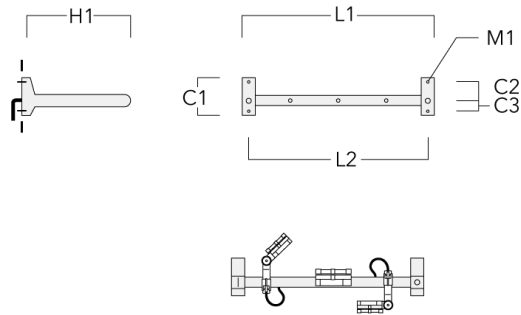

WE-EF LIGHTING USA, LLC

410-D Keystone Drive, 15086 Warrendale, PA 15086 - Phone: +1 724 742 0030
 customersupport.usa@we-ef.com - <https://we-ef.com/us>

Subject to technical changes and errors. - Generated on 11/27/2024