

108-1654

PIA240 LED

we-ef



Description

IP66, Class I. Class II on request. IK08. Marine-grade, die-cast aluminium alloy. 5CE superior corrosion protection including PCS hardware. Silicone CCG® Controlled Compression Gasket. Safety glass, hinged. Integral EC electronic converter. CAD-optimised optics for superior illumination and glare control. OLC® One LED Concept. Factory installed LED circuit board. Luminaire +15°/-30° tiltable.

Optional 2200 K version available. To be specified at time of ordering.

Weight	12.70 kg
Light distribution	rectangular, side throw [R65]
Light source	LED-18/54W / 1050 mA - 4000 K
CRI	80
Power supply	EC
LEDs	18
Rated input power	59 W

Nominal Lumen (lm)

LED Lumen	450
Total Lumen	8100
Tj	85

Rated lumens (lm)

LED Lumen	349.1
Total Lumen	6283.3
Ta	25

WE-EF LEUCHTEN GmbH

Töpinger Straße 16, 29646 Bispingen, Germany - Phone: +49 5194 909-0
info@we-ef.com - <https://we-ef.com>

Subject to technical changes and errors. - Generated on 23/11/2024

108-1654



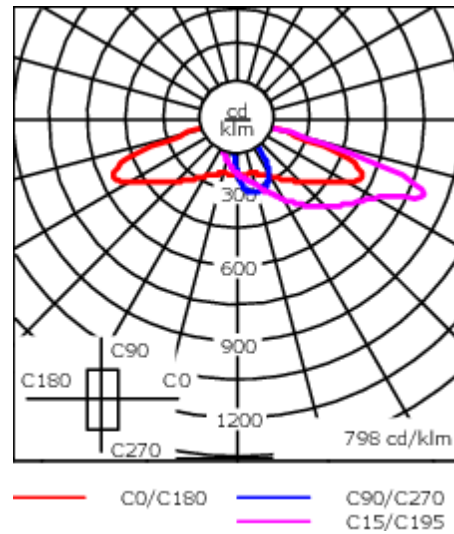
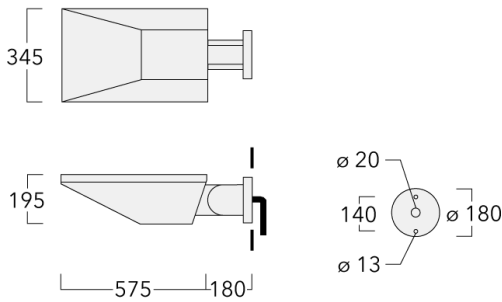

PIA240 LED

we-ef



Specifications

Material description

Body	Marine-grade die-cast aluminium alloy
Lens	Safety glass lens, hinged
Colours	 RAL9004 Signal black  RAL9006 White aluminium  RAL9007 Grey aluminium  RAL7016 Anthracite grey  RAL9016 Traffic white
Gasket	Silicone CCG® Controlled Compression Gasket
Fasteners	PCS Polymer Coated Stainless Steel Hardware
Ingress protection	IP66
Impact resistance	IK08
Corrosion resistance	5CE

Electrical description

Power supply	220-240V / 50-60 Hz
Driver / Ballast	Integral EC electronic converter

Additional information

Lifetime	Ta=25° L90B10 > 90000h
Energy efficiency class	C-D (Light source)

WE-EF LEUCHTEN GmbH

Töpinger Straße 16, 29646 Bispingen, Germany - Phone: +49 5194 909-0
info@we-ef.com - <https://we-ef.com>

Subject to technical changes and errors. - Generated on 23/11/2024