

147-0688

FLA730 LED

we-ef



Description

IP66. Class I. Marine-grade, die-cast aluminum alloy. 5CE superior corrosion protection including PCS hardware. Silicone CCG® Controlled Compression Gasket. Safety glass lens, hinged. PMMA OLC® One LED Concept optics for superior illumination and glare control. Factory-installed LED circuit board. LED boards can be easily removed for upgrading. 0-10V Dimming comes standard with luminaire. Protractor scale for accurate aiming from 0° to 15° above horizontal.

Recommended mounting height 10-20 ft, depending on lamp type selected.

Specify product with 7 Digit product code - Finish Color. Accessories, such as mounting, optical, and electrical, must be specified separately.

Example: XXX-XXXX-9004 (Black)
+ XXX-XXXX (Accessory 1)

Weight	16.31 lb
Light distribution	[R65] Type IV Medium
Light source	LED-12/24W / 700 mA - 4000 K
CRI	80
Power supply	electronic gear
BUG	B1 U0 G1
LEDs	12
Rated input power	27 W

Nominal Lumen (lm)

LED Lumen	310
Total Lumen	3720
Tj	85

Rated lumens (lm)

LED Lumen	216.9
Total Lumen	2602.3
Ta	25

WE-EF LIGHTING USA, LLC

410-D Keystone Drive, 15086 Warrendale, PA 15086 - Phone: +1 724 742 0030
customersupport.usa@we-ef.com - <https://we-ef.com/us>
Subject to technical changes and errors. - Generated on 11/23/2024

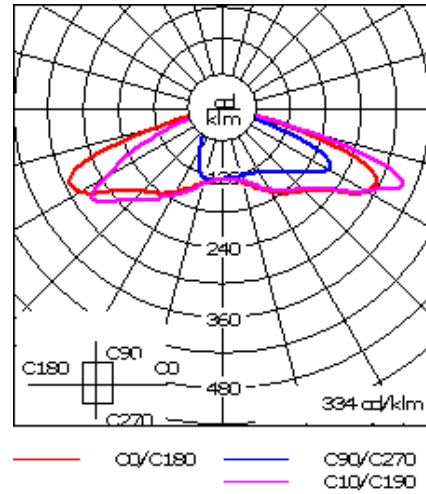
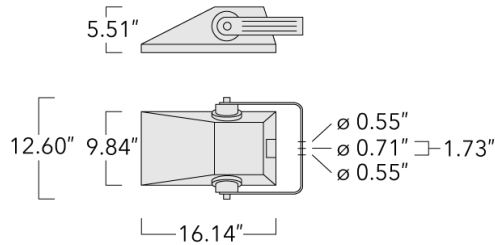

Specifications

Material description

Body	Marine-grade, die-cast aluminium alloy
Colors	<div style="display: flex; flex-direction: column; gap: 5px;"> <div> RAL9004 Black</div> <div> RAL9007 Grey Metallic</div> <div> RAL9016 White</div> <div> RAL8019 Dark Bronze</div> </div>
Gasket	Silicone rubber gasket
Ingress protection	IP66
Impact resistance	IK08
Corrosion resistance	5CE
Windage	0.5

Electrical description

Power supply	120-277V / 50-60 Hz
Driver / Ballast	Integral EC electronic converter
Surge protection	Integral 10kV Surge Protector

WE-EF LIGHTING USA, LLC

410-D Keystone Drive, 15086 Warrendale, PA 15086 - Phone: +1 724 742 0030
 customersupport.usa@we-ef.com - <https://we-ef.com/us>
 Subject to technical changes and errors. - Generated on 11/23/2024

147-0688

FLA730 LED

we-ef

Additional information

Lifetime	Ta=25°/40° L90B10 > 90000h
BUG Rating	Please see individual Spec Sheets for classification of Backlight, Uplight and Glare.
Listings	ETL, UL-1598, CSA-C22.2#250.0. Suitable for Wet Locations.

WE-EF LIGHTING USA, LLC

410-D Keystone Drive, 15086 Warrendale, PA 15086 - Phone: +1 724 742 0030
customersupport.usa@we-ef.com - <https://we-ef.com/us>
Subject to technical changes and errors. - Generated on 11/23/2024

147-0688

FLA730 LED

we-ef

Mounting Accessories

Surface Mount Canopy SMC

Description	Part ID	D1	D2	M1	Weight (lb)
SMC-730	147-6913	9.09	7.68	0.47	6 lbs

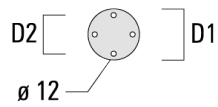

WE-EF LIGHTING USA, LLC

410-D Keystone Drive, 15086 Warrendale, PA 15086 - Phone: +1 724 742 0030

customersupport.usa@we-ef.com - <https://we-ef.com/us>

Subject to technical changes and errors. - Generated on 11/23/2024

147-0688

we-ef

FLA730 LED

Pole clamp TS

Description	Part ID	D1	Weight (lb)	D
TS1-2-730 Pole clamp, single (Ø 3"-3.5")	147-0371	3.0-3.50	3.09	76-89

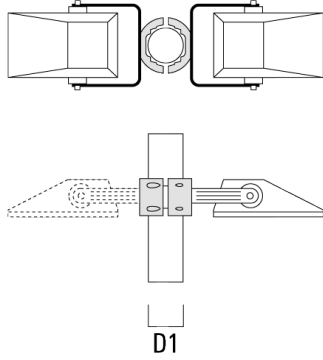

TS1-2-730 Pole clamp, single (Ø 4.0"-4.5")	147-0372	4.0-4.50	3.53	102-114
--	----------	----------	------	---------

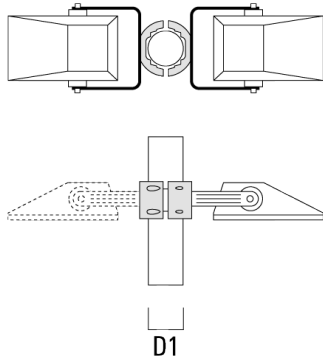

WE-EF LIGHTING USA, LLC

410-D Keystone Drive, 15086 Warrendale, PA 15086 - Phone: +1 724 742 0030
customersupport.usa@we-ef.com - <https://we-ef.com/us>
Subject to technical changes and errors. - Generated on 11/23/2024

147-0688

we-ef

FLA730 LED

Description	Part ID	D1	Weight (lb)	D
TS2-2-730 Pole clamp, double (Ø 3"-3.5")	147-0373	3.0-3.50	3.31	76-89

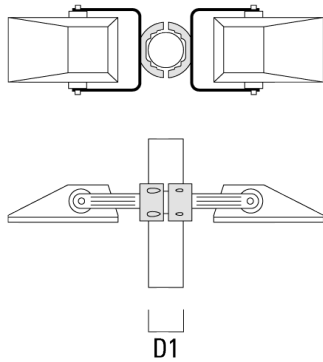

TS2-2-730 Pole clamp, double (Ø 4.0"-4.5")	147-0374	4.0-4.50	3.53	102-114
--	----------	----------	------	---------

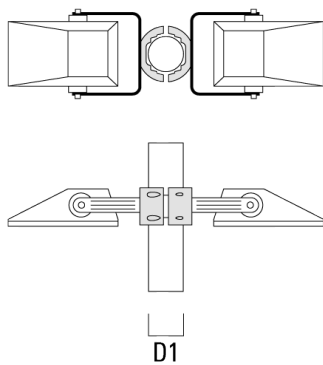

WE-EF LIGHTING USA, LLC

410-D Keystone Drive, 15086 Warrendale, PA 15086 - Phone: +1 724 742 0030
customersupport.usa@we-ef.com - <https://we-ef.com/us>

Subject to technical changes and errors. - Generated on 11/23/2024

147-0688

we-ef

FLA730 LED

Floodlight mounting bracket TA

Description	Part ID	A	C1	D x L1	Weight (lb)	D x S
TA1 Mounting bracket, single (Ø 3 x 8)	147-0397		5.12"	3 x 8	4.0 lbs	76 x 200

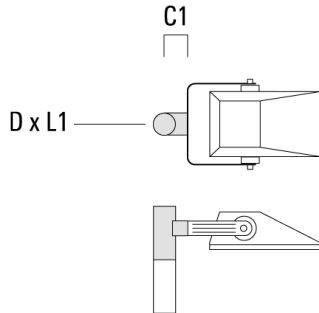

TA2 Mounting bracket, double (Ø 3 x 8)	147-0398		5.12"	3 x 8	4.0 lbs	76 x 200
--	----------	--	-------	-------	---------	----------

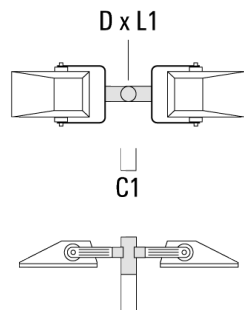

WE-EF LIGHTING USA, LLC

410-D Keystone Drive, 15086 Warrendale, PA 15086 - Phone: +1 724 742 0030
customersupport.usa@we-ef.com - <https://we-ef.com/us>

Subject to technical changes and errors. - Generated on 11/23/2024

147-0688

we-ef

FLA730 LED

Description	Part ID	A	C1	D x L1	Weight (lb)	D x S
TA3 Mounting bracket, triple (Ø 3 x 8)	147-0404	±90°	16.54"	3 x 8	39.46 lbs	76 x 200

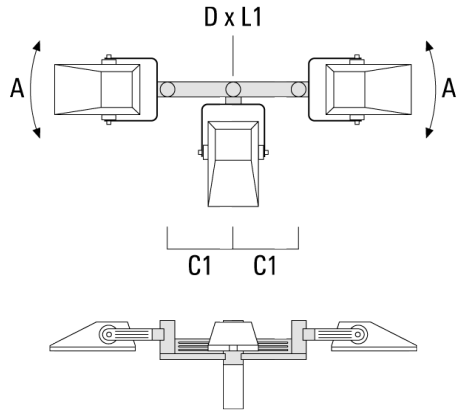

Planted root

Description	Part ID	D1	D2	D3	D4	H1	H2	M1	Weight (lb)
Planted root ESV4	300-0461	5.71	5.12	4.01	4.25	15.75	13.78	.31	15.54

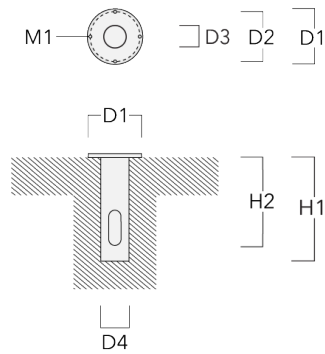

WE-EF LIGHTING USA, LLC

410-D Keystone Drive, 15086 Warrendale, PA 15086 - Phone: +1 724 742 0030

customersupport.usa@we-ef.com - <https://we-ef.com/us>

Subject to technical changes and errors. - Generated on 11/23/2024

147-0688

FLA730 LED

we-ef

Short post EM

Description	Part ID	D1	D2	H1	M1	Weight (lb)
EM1-M16	270-9038	6.3	5.12	7.87"	0.35"	4.85 lbs

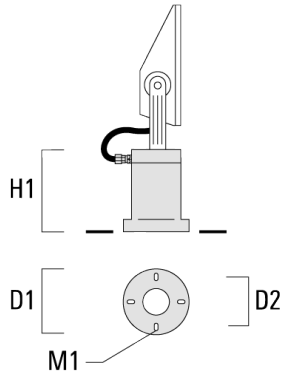

WE-EF LIGHTING USA, LLC

410-D Keystone Drive, 15086 Warrendale, PA 15086 - Phone: +1 724 742 0030
customersupport.usa@we-ef.com - <https://we-ef.com/us>

Subject to technical changes and errors. - Generated on 11/23/2024

147-0688

FLA730 LED

we-ef

Optical Accessories

Light shield

Description	Part ID	Additional information
LS180-[A60]	430-0038	Light shield LS180 to greatly reduce or eliminate light pollution. PA injection moulded component, black matt. Suitable for asymmetric light distribution [A60].
LS180	430-0029	Glare Shield for backlight spill. Glare Shield factory-installed or available as retrofit kit. Suitable for [S60], [S65], [S70], [R65], [P65] lenses. Must be specified at time of ordering.

WE-EF LIGHTING USA, LLC

410-D Keystone Drive, 15086 Warrendale, PA 15086 - Phone: +1 724 742 0030
customersupport.usa@we-ef.com - <https://we-ef.com/us>

Subject to technical changes and errors. - Generated on 11/23/2024