

147-0709

FLA740 LED

we-ef



Description

IP66. IK08. Marine-grade, die-cast aluminium alloy. 5CE superior corrosion protection including PCS hardware. Safety glass lens, hinged. Silicone CCG® Controlled Compression Gasket.

Integral electronic converter with DALI interface in thermally-shielded compartment. Advanced thermal management protects LEDs while optimising lumens output. Removable LED boards for upgrading. CAD-optimised optics for superior illumination and glare control. OLC® One LED Concept. Optional 2200 K version available. To be specified at time of ordering.

Protractor scale for accurate aiming from 0° to 15° above horizontal.

Including 0.5 m cable with a cable connector.

| | |
|--------------------|------------------------------|
| Weight | 9.60 kg |
| Light distribution | asymmetric, side throw [S65] |
| Light source | LED-18/36W / 700 mA - 3000 K |
| CRI | 80 |
| Power supply | EC |
| BUG | B1 U0 G1 |
| LEDs | 18 |
| Rated input power | 41 W |

Nominal Lumen (lm)

| | |
|-------------|------|
| LED Lumen | 290 |
| Total Lumen | 5220 |
| Tj | 85 |

Rated lumens (lm)

| | |
|-------------|--------|
| LED Lumen | 232.4 |
| Total Lumen | 4182.9 |
| Ta | 25 |

WE-EF LIGHTING (Thailand) Co., Ltd.

57 Moo 5, Kingkaew Rd., Bangplee, 10540 Samutprakarn - Phone: +66 2 738 96 20 - Fax: +66 2 738 96 29

<https://we-ef.com/asia>

Subject to technical changes and errors. - Generated on 23/10/2024

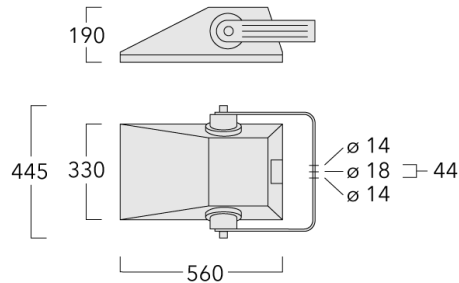

Specifications

Material description

| | |
|----------------------|--|
| Body | Marine-grade, die-cast aluminium alloy |
| Lens | Safety glass lens, hinged |
| Colours | <div style="display: flex; align-items: center; gap: 10px;"> <div style="width: 20px; height: 15px; background-color: black; margin-right: 5px;"></div> RAL9004 Signal black <div style="width: 20px; height: 15px; background-color: grey; margin-right: 5px;"></div> RAL9007 Grey aluminium <div style="width: 20px; height: 15px; background-color: darkgrey; margin-right: 5px;"></div> RAL7016 Anthracite grey <div style="width: 20px; height: 15px; background-color: white; margin-right: 5px;"></div> RAL9016 Traffic white </div> |
| Gasket | Silicone CCG® Controlled Compression Gasket |
| Fasteners | PCS Polymer Coated Stainless Steel Hardware |
| Ingress protection | IP66 |
| Impact resistance | IK08 |
| Corrosion resistance | 5CE |
| Windage | 0.09 m ² |

Electrical description

| | |
|------------------|---|
| Power supply | 220-240V / 50-60 Hz |
| Driver / Ballast | Integral electronic converter with DALI interface in thermally-shielded compartment |

Additional information

| | |
|------------|--|
| Lifetime | Ta=25° L90B10 > 90000h |
| BUG Rating | Please see individual Spec Sheets for classification of Backlight, Uplight and Glare |

Mounting Accessories

Pole clamp

| Description | Part ID | D1 | Weight (kg) | D |
|--|----------|-------|-------------|-------|
| Pole clamp TS1-2/M12, single (Ø 76-89) | 147-0543 | 76-89 | 1.40 | 76-89 |

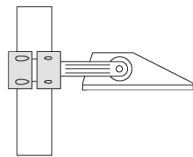

D1

| | | | | |
|--|----------|-------|------|-------|
| Pole clamp TS2-2/M12, double (Ø 76-89) | 147-0545 | 76-89 | 1.40 | 76-89 |
|--|----------|-------|------|-------|

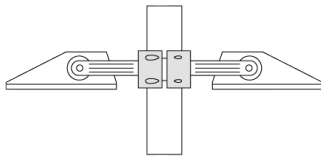
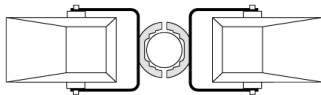

D1

FLA740 LED

| Description | Part ID | D1 | Weight (kg) | D |
|--|----------|-----------|-------------|---|
| Pole clamp TS1-2/M12, single (Ø 114-140) | 147-0643 | 114 x 140 | 1.70 | |

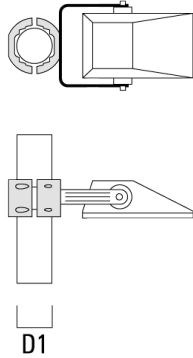

Floodlight mounting bracket TA

| Description | Part ID | C1 | D × L1 | Weight (kg) | D × S |
|---|----------|-----|----------|-------------|----------|
| Mounting fitter TA1, single* (Ø 76 x 200) | 147-0023 | 130 | 76 x 200 | 1.90 | 76 x 200 |

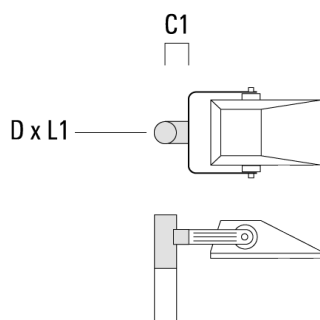

147-0709

FLA740 LED

we-ef

| Description | Part ID | C1 | D × L1 | Weight (kg) | D × S |
|---|----------|-----|----------|-------------|----------|
| Mounting fitter TA2, double* (Ø 76 x 200) | 147-0024 | 130 | 76 x 200 | 1.90 | 76 x 200 |

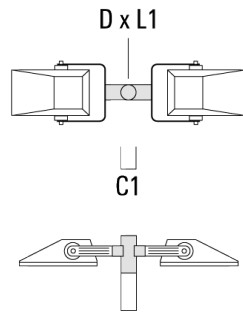

WE-EF LIGHTING (Thailand) Co., Ltd.

57 Moo 5, Kingkaew Rd., Bangplee, 10540 Samutprakarn - Phone: +66 2 738 96 20 - Fax: +66 2 738 96 29

<https://we-ef.com/asia>

Subject to technical changes and errors. - Generated on 23/10/2024

147-0709

FLA740 LED

WE-EF LIGHTING (Thailand) Co., Ltd.

57 Moo 5, Kingkaew Rd., Bangplee, 10540 Samutprakarn

Phone: +66 2 738 96 20

Fax: +66 2 738 96 29

<https://we-ef.com/asia>

Subject to technical changes and errors.

Generated on 23/10/2024