

147-0723

FLA740 LED

**we-ef**



#### Description

IP66. IK08. Marine-grade, die-cast aluminium alloy. 5CE superior corrosion protection including PCS hardware. Safety glass lens, hinged. Silicone CCG® Controlled Compression Gasket.

Integral electronic converter with DALI interface in thermally-shielded compartment. Advanced thermal management protects LEDs while optimising lumens output. Removable LED boards for upgrading. CAD-optimised optics for superior illumination and glare control. OLC® One LED Concept. Optional 2200 K version available. To be specified at time of ordering.

Protractor scale for accurate aiming from 0° to 15° above horizontal.

Including 0.5 m cable with a cable connector.

|                    |                               |
|--------------------|-------------------------------|
| Weight             | 9.60 kg                       |
| Light distribution | rectangular, side throw [R65] |
| Light source       | LED-24/48W / 700 mA - 3000 K  |
| CRI                | 80                            |
| Power supply       | EC                            |
| BUG                | B1 U0 G1                      |
| LEDs               | 24                            |
| Rated input power  | 54 W                          |

#### Nominal Lumen (lm)

|             |      |
|-------------|------|
| LED Lumen   | 290  |
| Total Lumen | 6960 |
| Tj          | 85   |

#### Rated lumens (lm)

|             |        |
|-------------|--------|
| LED Lumen   | 211.7  |
| Total Lumen | 5081.1 |
| Ta          | 25     |

**WE-EF LIGHTING (Thailand) Co., Ltd.**

57 Moo 5, Kingkaew Rd., Bangplee, 10540 Samutprakarn - Phone: +66 2 738 96 20 - Fax: +66 2 738 96 29

<https://we-ef.com/asia>

Subject to technical changes and errors. - Generated on 23/11/2024

147-0723



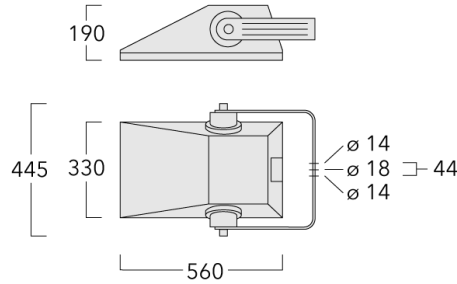

FLA740 LED

**we-ef**



## Specifications

### Material description

|                      |  |
|----------------------|--|
| Body                 | Marine-grade, die-cast aluminium alloy   |
| Lens                 | Safety glass lens, hinged  |
| Colours              |  RAL9004 Signal black<br> RAL9007 Grey aluminium<br> RAL7016 Anthracite grey<br> RAL9016 Traffic white |
| Gasket               | Silicone CCG® Controlled Compression Gasket  |
| Fasteners            | PCS Polymer Coated Stainless Steel Hardware  |
| Ingress protection   | IP66   |
| Impact resistance    | IK08   |
| Corrosion resistance | 5CE  |
| Windage              | 0.09 m <sup>2</sup>  |

### Electrical description

|                  |   |
|------------------|---|
| Power supply     | 220-240V / 50-60 Hz   |
| Driver / Ballast | Integral electronic converter with DALI interface in thermally-shielded compartment |

### Additional information

|            |  |
|------------|--|
| Lifetime   | Ta=25° L90B10 > 90000h   |
| BUG Rating | Please see individual Spec Sheets for classification of Backlight, Uplight and Glare |

**WE-EF LIGHTING (Thailand) Co., Ltd.**

57 Moo 5, Kingkaew Rd., Bangplee, 10540 Samutprakarn - Phone: +66 2 738 96 20 - Fax: +66 2 738 96 29

<https://we-ef.com/asia>

Subject to technical changes and errors. - Generated on 23/11/2024

## Mounting Accessories

### Pole clamp

| Description                            | Part ID  | D1    | Weight (kg) | D     |
|--|----------|-------|-------------|-------|
| Pole clamp TS1-2/M12, single (Ø 76-89) | 147-0543 | 76-89 | 1.40        | 76-89 |

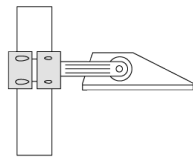

D1

|  |          |       |      |       |
|--|----------|-------|------|-------|
| Pole clamp TS2-2/M12, double (Ø 76-89) | 147-0545 | 76-89 | 1.40 | 76-89 |
|--|----------|-------|------|-------|

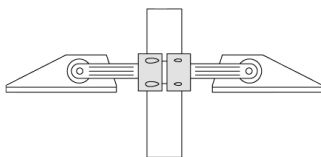
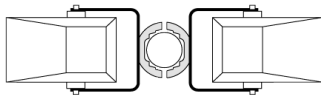

D1

147-0723

FLA740 LED

**we-ef**

| Description                              | Part ID  | D1        | Weight (kg) | D |
|--|----------|-----------|-------------|---|
| Pole clamp TS1-2/M12, single (Ø 114-140) | 147-0643 | 114 x 140 | 1.70        |   |

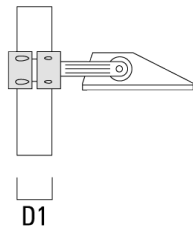
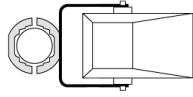

### Floodlight mounting bracket TA

| Description                               | Part ID  | C1  | D x L1   | Weight (kg) | D x S    |
|---|----------|-----|----------|-------------|----------|
| Mounting fitter TA1, single* (Ø 76 x 200) | 147-0023 | 130 | 76 x 200 | 1.90        | 76 x 200 |

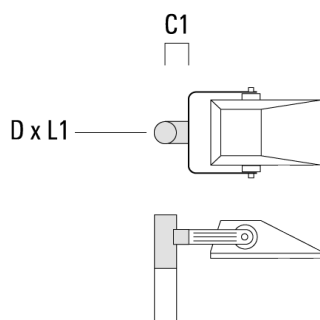

**WE-EF LIGHTING (Thailand) Co., Ltd.**

57 Moo 5, Kingkaew Rd., Bangplee, 10540 Samutprakarn - Phone: +66 2 738 96 20 - Fax: +66 2 738 96 29

<https://we-ef.com/asia>

Subject to technical changes and errors. - Generated on 23/11/2024

147-0723

FLA740 LED

**we-ef**

---

| Description                               | Part ID  | C1  | D × L1   | Weight (kg) | D × S    |
|---|----------|-----|----------|-------------|----------|
| Mounting fitter TA2, double* (Ø 76 x 200) | 147-0024 | 130 | 76 x 200 | 1.90        | 76 x 200 |

---

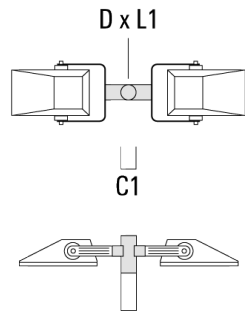

**WE-EF LIGHTING (Thailand) Co., Ltd.**

57 Moo 5, Kingkaew Rd., Bangplee, 10540 Samutprakarn - Phone: +66 2 738 96 20 - Fax: +66 2 738 96 29

<https://we-ef.com/asia>

Subject to technical changes and errors. - Generated on 23/11/2024