

147-0726

FLA740 LED

we-ef



Description

IP66, Class I. IK08. Marine-grade, die-cast aluminium alloy. 5CE superior corrosion protection including PCS hardware. Silicone rubber gasket. Safety glass lens, hinged. Protractor scale for accurate aiming from 0° to 15° above horizontal. Integral EC electronic converter in thermally separated compartment. DALI. CAD-optimised optics for superior illumination and glare control. OLC® One LED Concept. Factory installed LED circuit board.

Optional 2200 K version available. To be specified at time of ordering.

| | |
|--------------------|---------------------------------|
| Weight | 9.60 kg |
| Light distribution | asymmetric, forward throw [A60] |
| Light source | LED-24/48W / 700 mA - 4000 K |
| CRI | 80 |
| Power supply | EC |
| LEDs | 24 |
| Rated input power | 54 W |

Nominal Lumen (lm)

| | |
|-------------|------|
| LED Lumen | 310 |
| Total Lumen | 7440 |
| Tj | 85 |

Rated lumens (lm)

| | |
|-------------|--------|
| LED Lumen | 231.6 |
| Total Lumen | 5558.1 |
| Ta | 25 |

WE-EF LEUCHTEN GmbH

Töpinger Straße 16, 29646 Bispingen, Germany - Phone: +49 5194 909-0
info@we-ef.com - <https://we-ef.com>

Subject to technical changes and errors. - Generated on 23/11/2024

147-0726



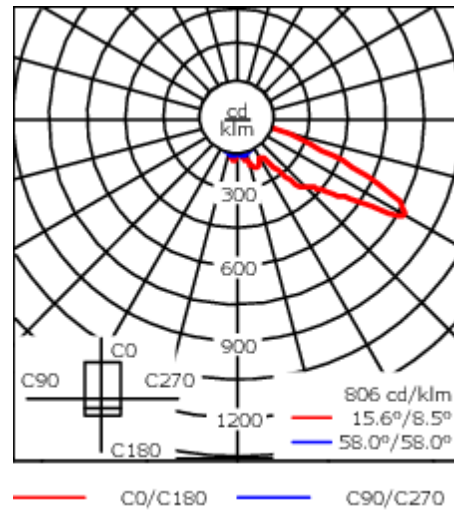
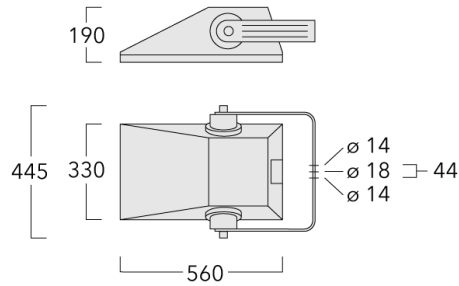

FLA740 LED

we-ef



Specifications

Material description

| | |
|----------------------|---|
| Body | Marine-grade, die-cast aluminium alloy |
| Lens | Safety glass lens, hinged |
| Colours |  RAL9004 Signal black  RAL9006 White aluminium  RAL9007 Grey aluminium  RAL7016 Anthracite grey  RAL9016 Traffic white |
| Gasket | Silicone rubber gasket |
| Fasteners | PCS Polymer Coated Stainless Steel Hardware |
| Ingress protection | IP66 |
| Impact resistance | IK08 |
| Corrosion resistance | 5CE |
| Windage | 0.09 m ² |

Electrical description

| | |
|------------------|--|
| Power supply | 220-240V / 50-60 Hz |
| Driver / Ballast | Integral EC electronic converter. DALI |
| Surge protection | 6/6 kV (optional SP10) |

WE-EF LEUCHTEN GmbH

Töpinger Straße 16, 29646 Bispingen, Germany - Phone: +49 5194 909-0
info@we-ef.com - <https://we-ef.com>

Subject to technical changes and errors. - Generated on 23/11/2024

147-0726

FLA740 LED

we-ef

Additional information

Lifetime Ta=25° L90B10 > 90000h

Energy efficiency class C-D (Light source)

WE-EF LEUCHTEN GmbH

Töpinger Straße 16, 29646 Bispingen, Germany - Phone: +49 5194 909-0
info@we-ef.com - <https://we-ef.com>

Subject to technical changes and errors. - Generated on 23/11/2024

Mounting Accessories

Pole clamp TS

| Description | Part ID | D1 | Weight (kg) | D |
|--|----------|-------|-------------|-------|
| TS1-2/M12 Pole clamp, single (Ø 76-89) | 147-0543 | 76-89 | 1.40 | 76-89 |

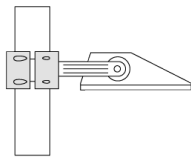
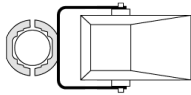

D1

| | | | | |
|--|----------|-------|------|-------|
| TS2-2/M12 Pole clamp, double (Ø 76-89) | 147-0545 | 76-89 | 1.40 | 76-89 |
|--|----------|-------|------|-------|

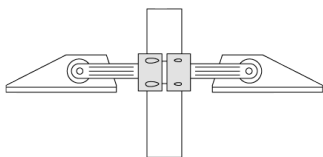
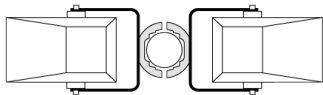

D1

147-0726

FLA740 LED

we-ef

| Description | Part ID | D1 | Weight (kg) | D |
|--|----------|---------|-------------|---------|
| TS2-2/M12 Pole clamp, double (Ø 114-133) | 147-0546 | 114-133 | 1.60 | 114-133 |



| | | | | |
|--|----------|---------|------|---------|
| TS1-2/M12 Pole clamp, single (Ø 102-114) | 147-0526 | 102-114 | 1.50 | 102-114 |
|--|----------|---------|------|---------|



WE-EF LEUCHTEN GmbH

Töpinger Straße 16, 29646 Bispingen, Germany - Phone: +49 5194 909-0
info@we-ef.com - <https://we-ef.com>

Subject to technical changes and errors. - Generated on 23/11/2024

147-0726

FLA740 LED

we-ef

| Description | Part ID | D1 | Weight (kg) | D |
|--|----------|---------|-------------|---------|
| TS1-2/M12 Pole clamp, single (Ø 114-133) | 147-0544 | 114-133 | 1.70 | 114-133 |



| | | | | |
|--|----------|---------|------|---------|
| TS2-2/M12 Pole clamp, double (Ø 102-114) | 147-0527 | 102-114 | 1.50 | 102-114 |
|--|----------|---------|------|---------|

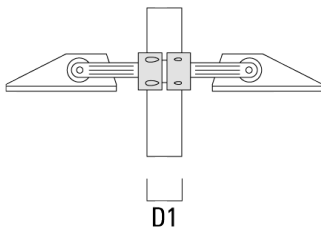
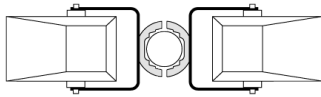

WE-EF LEUCHTEN GmbH

Töpinger Straße 16, 29646 Bispingen, Germany - Phone: +49 5194 909-0
info@we-ef.com - <https://we-ef.com>

Subject to technical changes and errors. - Generated on 23/11/2024

Floodlight mounting bracket TA

| Description | Part ID | A | C1 | D x L1 | Weight (kg) | D x S |
|---|----------|-----|-----|----------|-------------|----------|
| TA3-L Mounting bracket, triple (Ø 89 x 200) | 147-0557 | ±9° | 690 | 89 x 200 | 20.80 | 89 x 200 |

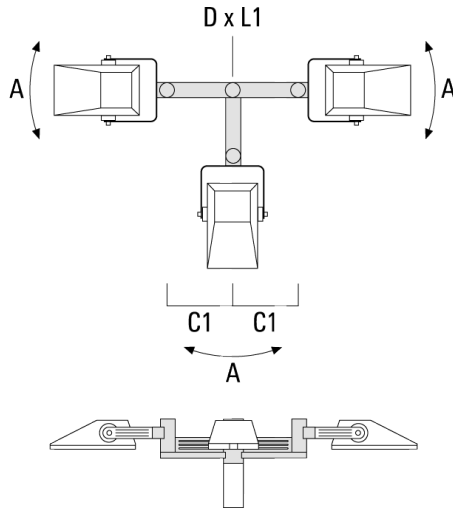

| | | | | | | |
|--|----------|--|-----|----------|------|----------|
| TA1 Mounting bracket, single* (Ø 76 x 200) | 147-0023 | | 130 | 76 x 200 | 1.90 | 76 x 200 |
|--|----------|--|-----|----------|------|----------|

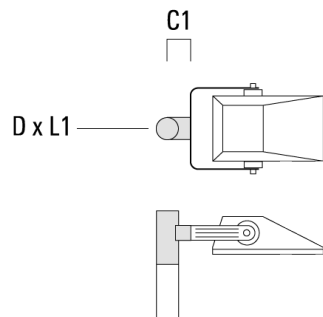

FLA740 LED

| Description | Part ID | A | C1 | D x L1 | Weight (kg) | D x S |
|--|----------|---|-----|----------|-------------|----------|
| TA2 Mounting bracket, double* (Ø 76 x 200) | 147-0024 | | 130 | 76 x 200 | 1.90 | 76 x 200 |



| | | | | | | |
|---|----------|------|-----|----------|-------|----------|
| TA2-L Mounting bracket, double (Ø 76 x 200) | 147-0105 | ±90° | 420 | 76 x 200 | 16.10 | 76 x 200 |
|---|----------|------|-----|----------|-------|----------|

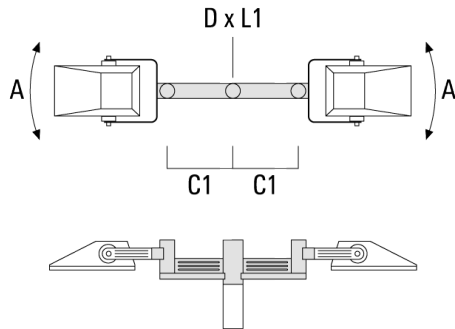

147-0726

FLA740 LED

we-ef

| Description | Part ID | A | C1 | D x L1 | Weight (kg) | D x S |
|---|----------|-----|-----|----------|-------------|--------|
| TA4-L Mounting bracket, quad (Ø 89 x 200) | 147-0465 | ±9° | 690 | 89 x 200 | 22.60 | 89x200 |

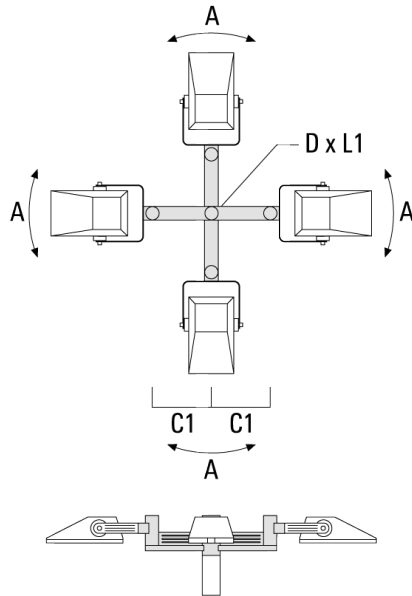

WE-EF LEUCHTEN GmbH

Töpinger Straße 16, 29646 Bispingen, Germany - Phone: +49 5194 909-0
info@we-ef.com - <https://we-ef.com>

Subject to technical changes and errors. - Generated on 23/11/2024

Optical Accessories

Light shield

| Description | Part ID | Additional information |
|-------------|----------|---|
| LS180-[A60] | 430-0038 | Light shield LS180 to greatly reduce or eliminate light pollution. PA injection moulded component, black matt. Suitable for asymmetric light distribution [A60]. |
| LS180 | 430-0029 | Glare Shield for backlight spill. Glare Shield factory-installed or available as retrofit kit. Suitable for [S60], [S65], [S70], [R65], [P65] lenses. Must be specified at time of ordering. |