

147-0702

FLA740 LED

we-ef



Description

IP66. IK08. Marine-grade, die-cast aluminium alloy. 5CE superior corrosion protection including PCS hardware. Safety glass lens, hinged. Silicone CCG® Controlled Compression Gasket.

Integral electronic converter with DALI interface in thermally-shielded compartment. Advanced thermal management protects LEDs while optimising lumens output. Removable LED boards for upgrading. CAD-optimised optics for superior illumination and glare control. OLC® One LED Concept. Optional 2200 K version available. To be specified at time of ordering.

Protractor scale for accurate aiming from 0° to 15° above horizontal.

Including 0.5 m cable with a cable connector.

Weight	9.60 kg
Light distribution	asymmetric, forward throw [A60]
Light source	LED-18/54W / 1050 mA - 4000 K
CRI	80
Power supply	EC
BUG	B1 U0 G2
LEDs	18
Rated input power	59 W

Nominal Lumen (lm)

LED Lumen	450
Total Lumen	8100
Tj	85

Rated lumens (lm)

LED Lumen	336.2
Total Lumen	6051.1
Ta	25

WE-EF LIGHTING (Thailand) Co., Ltd.

57 Moo 5, Kingkaew Rd., Bangplee, 10540 Samutprakarn - Phone: +66 2 738 96 20 - Fax: +66 2 738 96 29

<https://we-ef.com/asia>

Subject to technical changes and errors. - Generated on 24/11/2024

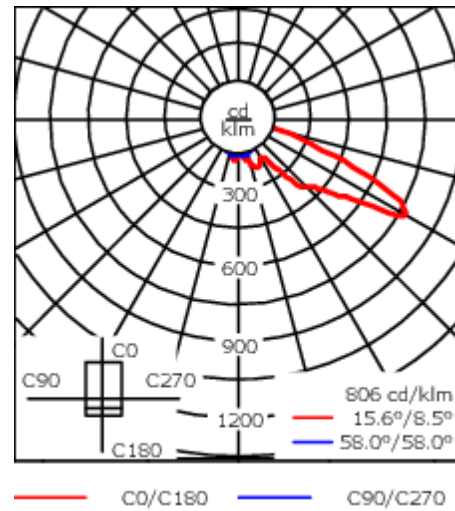
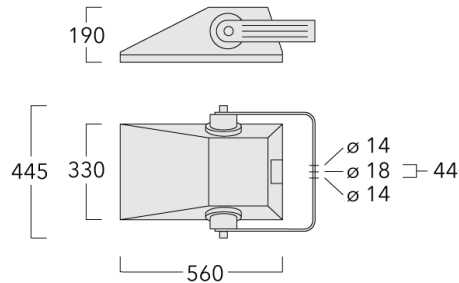

Specifications

Material description

Body	Marine-grade, die-cast aluminium alloy
Lens	Safety glass lens, hinged
Colours	<div style="display: flex; align-items: center;"> <div style="width: 20px; height: 15px; background-color: black; margin-right: 5px;"></div> RAL9004 Signal black </div> <div style="display: flex; align-items: center; margin-top: 5px;"> <div style="width: 20px; height: 15px; background-color: grey; margin-right: 5px;"></div> RAL9007 Grey aluminium </div> <div style="display: flex; align-items: center; margin-top: 5px;"> <div style="width: 20px; height: 15px; background-color: darkgrey; margin-right: 5px;"></div> RAL7016 Anthracite grey </div> <div style="display: flex; align-items: center; margin-top: 5px;"> <div style="width: 20px; height: 15px; background-color: lightgrey; margin-right: 5px;"></div> RAL9016 Traffic white </div>
Gasket	Silicone CCG® Controlled Compression Gasket
Fasteners	PCS Polymer Coated Stainless Steel Hardware
Ingress protection	IP66
Impact resistance	IK08
Corrosion resistance	5CE
Windage	0.09 m ²

Electrical description

Power supply	220-240V / 50-60 Hz
Driver / Ballast	Integral electronic converter with DALI interface in thermally-shielded compartment

Additional information

Lifetime	Ta=25° L90B10 > 90000h
BUG Rating	Please see individual Spec Sheets for classification of Backlight, Uplight and Glare

WE-EF LIGHTING (Thailand) Co., Ltd.

57 Moo 5, Kingkaew Rd., Bangplee, 10540 Samutprakarn - Phone: +66 2 738 96 20 - Fax: +66 2 738 96 29

<https://we-ef.com/asia>

Subject to technical changes and errors. - Generated on 24/11/2024

Mounting Accessories

Pole clamp

Description	Part ID	D1	Weight (kg)	D
Pole clamp TS1-2/M12, single (Ø 76-89)	147-0543	76-89	1.40	76-89

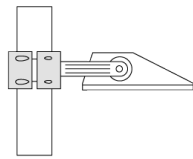
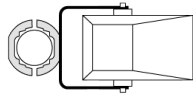

D1

Pole clamp TS2-2/M12, double (Ø 76-89)	147-0545	76-89	1.40	76-89
--	----------	-------	------	-------

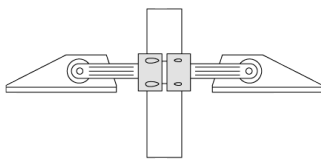
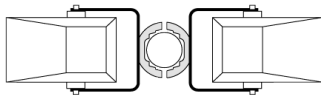

D1

FLA740 LED

Description	Part ID	D1	Weight (kg)	D
Pole clamp TS1-2/M12, single (Ø 114-140)	147-0643	114 x 140	1.70	

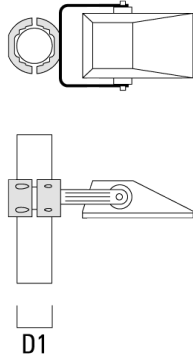

Floodlight mounting bracket TA

Description	Part ID	C1	D x L1	Weight (kg)	D x S
Mounting fitter TA1, single* (Ø 76 x 200)	147-0023	130	76 x 200	1.90	76 x 200

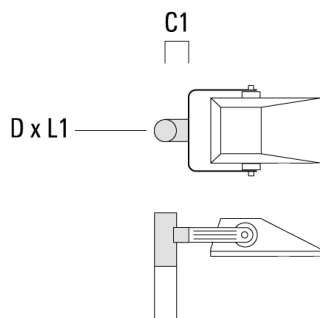

147-0702

FLA740 LED

we-ef

Description	Part ID	C1	D × L1	Weight (kg)	D × S
Mounting fitter TA2, double* (Ø 76 x 200)	147-0024	130	76 x 200	1.90	76 x 200

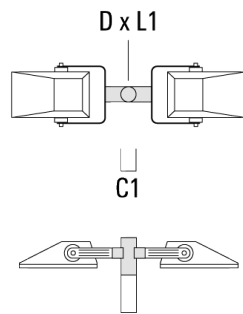

WE-EF LIGHTING (Thailand) Co., Ltd.

57 Moo 5, Kingkaew Rd., Bangplee, 10540 Samutprakarn - Phone: +66 2 738 96 20 - Fax: +66 2 738 96 29

<https://we-ef.com/asia>

Subject to technical changes and errors. - Generated on 24/11/2024