

108-1699

PFL240 LED

**we-ef**



### Description

IP66. Classe I. Classe II sur demande. IK08. Corps en fonte d'aluminium. Visserie inox avec traitement PCS. Protection contre la corrosion 5CE. CCG® joint silicone. Vitre RFC® monté dans un cadre aluminium suspendable. Modules LED interchangeables avec dissipateur de chaleur. Lentille PMMA avec technologie OLC® pour la maîtrise du flux et la précision de l'éclairage. Option : Fixation latérale (voir accessoires de montage) Hauteur de mât recommandée selon la puissance: 2 à 8m.

Version en 2200K disponible. À préciser lors de la demande de devis..

Poids	13.50 kg
Distribution de la lumière	[S65] Eclairage routier - basses luminances
Source lumineuse	LED-18/36W / 700 mA - 3000 K
IRC	80
Alimentation électrique	ballast électronique
LEDs	18
Rated input power	41 W

### Flux lumineux nominal (lm)

LED Lumen	290
Total Lumen	5220
Tj	85

### Rated lumens (lm)

LED Lumen	232.4
Total Lumen	4182.7
Ta	25

### WE-EF Switzerland AG

Himmelrichstrasse 6, 6003 Luzern - Téléphone: +41 22 752 49 94

info.switzerland@we-ef.com - [https://we-ef.com/ch\\_fr](https://we-ef.com/ch_fr)

Sous réserve de modifications techniques et d'erreurs. - Généré le 23/11/2024

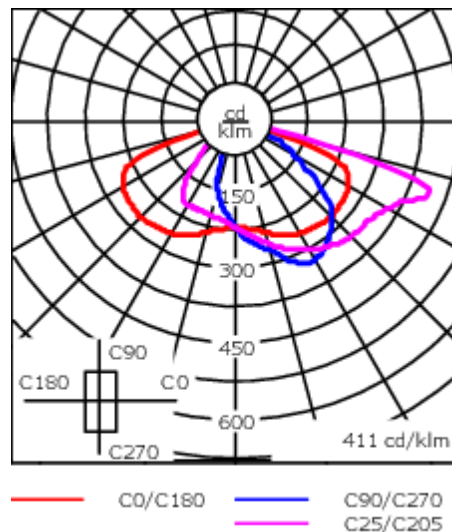
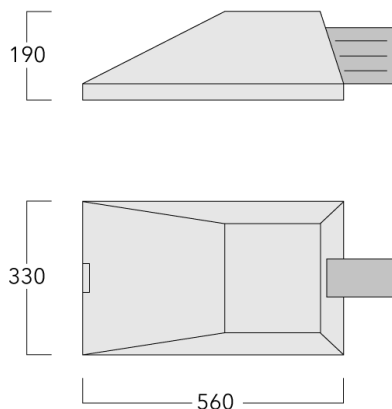

## Spécifications

### Description du matériel

Corps	Corps en fonte d'aluminium, visserie inox avec traitement PCS
Lentille	Verre de sécurité sur charnière
Couleurs	<div style="display: flex; align-items: center;"> <div style="width: 20px; height: 10px; background-color: black; margin-right: 5px;"></div> <span>RAL9004 Noir de sécurité</span> </div> <div style="display: flex; align-items: center; margin-top: 5px;"> <div style="width: 20px; height: 10px; background-color: gray; margin-right: 5px;"></div> <span>RAL9007 Aluminium gris</span> </div> <div style="display: flex; align-items: center; margin-top: 5px;"> <div style="width: 20px; height: 10px; background-color: darkgray; margin-right: 5px;"></div> <span>RAL7016 Gris anthracite</span> </div> <div style="display: flex; align-items: center; margin-top: 5px;"> <div style="width: 20px; height: 10px; background-color: lightgray; margin-right: 5px;"></div> <span>RAL9016 Blanc signalisation</span> </div>
Joint	Joint silicone CCG®
Visserie	PCS Inox avec recouvrement polymère
IP	IP66
IK	IK08
Protection contre la corrosion	5CE
Surface exposée au vent	0.075 m <sup>2</sup>

### Description électrique

Alimentation électrique	220-240V / 50-60 Hz
Driver	Driver électronique. DALI
Power factor	> 0.9

#### WE-EF Switzerland AG

Himmelrichstrasse 6, 6003 Luzern - Téléphone: +41 22 752 49 94

info.switzerland@we-ef.com - [https://we-ef.com/ch\\_fr](https://we-ef.com/ch_fr)

Sous réserve de modifications techniques et d'erreurs. - Généré le 23/11/2024

**108-1699**

**PFL240 LED**

**we-ef**

### **Informations complémentaires**

---

Durée de vie Ta=25° L90B10 > 90000h

Classe d'efficacité  
énergétique C-D

---

**WE-EF Switzerland AG**

Himmelrichstrasse 6, 6003 Luzern - Téléphone: +41 22 752 49 94

info.switzerland@we-ef.com - [https://we-ef.com/ch\\_fr](https://we-ef.com/ch_fr)

Sous réserve de modifications techniques et d'erreurs. - Généré le 23/11/2024

**108-1699**

**PFL240 LED**

**we-ef**

## **Control**

### **Eco Step Dim® Basic**

Description	Référence
Eco Step Dim® Basic LED	430-0001

### **Eco Step Dim® Advanced**

Description	Référence
Eco Step Dim® Advanced LED	430-0002

#### **WE-EF Switzerland AG**

Himmelrichstrasse 6, 6003 Luzern - Téléphone: +41 22 752 49 94

info.switzerland@we-ef.com - [https://we-ef.com/ch\\_fr](https://we-ef.com/ch_fr)

Sous réserve de modifications techniques et d'erreurs. - Généré le 23/11/2024

**Accessoires d'installation**

**Crosses murales et Crosses pour mât KI**

Description	Référence	A	C1	D1	D2	H1	M1	Poids (kg)	Alpha	C	D	H
KI0-240/260 crose murable réglable	108-0493	±30°	210	180	140		12	5.70	±3°	210	180	180

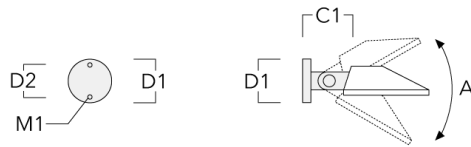

KI1-240 crose simple réglable	108-0491	±30°	210			525		6.90	+15° / -30°	210		525
-------------------------------	----------	------	-----	--	--	-----	--	------	-------------	-----	--	-----

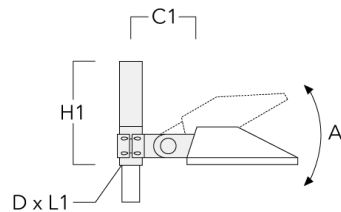

Description	Référence	A	C1	D1	D2	H1	M1	Poids (kg)	Alpha	C	D	H
KI2-240 crosse double réglable	108-0492	$\pm 30^\circ$	210			525		8.60	$+15^\circ / -30^\circ$	210		525

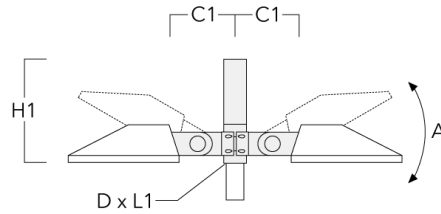

### Crosses pour mât KL

Description	Référence	C1	D x L1	H1	Poids (kg)	C	H
KL1-240 crosse simple	108-0342	735	76 x 130	750	9	725	750



Description	Référence	C1	D x L1	H1	Poids (kg)	C	H
KX2-240 crosse double	108-0532	735	76 x 130	750	14	725	750

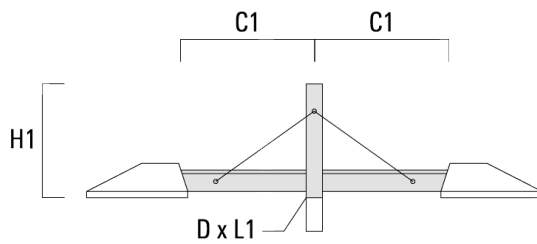

### Crosses murales et Crosses pour mât KP

Description	Référence	C1	D1	D2	D x L1	H1	M1	Poids (kg)	C	D	H
KP0-240 crosse murale	108-0103	200	230	195			12	2	175	230	230

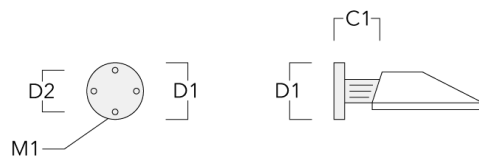

Description	Référence	C1	D1	D2	D x L1	H1	M1	Poids (kg)	C	D	H
KP1-240 crosse simple	108-0104	215			76 x 80	575		3.80	175		575

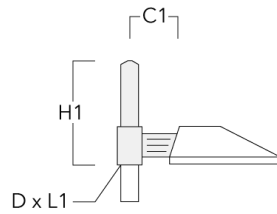

KP2-240 crosse simple	108-0105	215			76 x 80	575		3.80	175		575
-----------------------	----------	-----	--	--	---------	-----	--	------	-----	--	-----





## Crosses murales et Crosses pour mât KP\_L

Description	Référence	C1	D x L1	H1	Poids (kg)	C	H
KP1-L-240 crose simple longue	108-0268	635	76 x 130	575	9.10	175	575

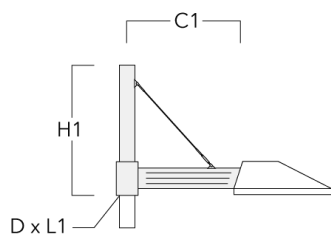

KP2-L-240 crose double	108-0373	635	76 x 130	575	15	175	575
------------------------	----------	-----	----------	-----	----	-----	-----

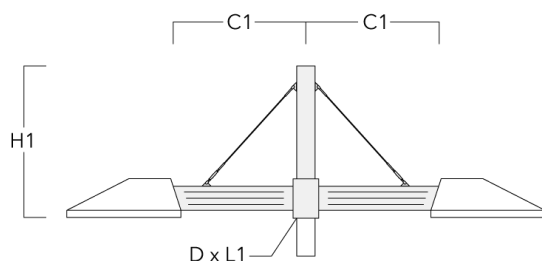

## Crosses pour mât KX

Description	Référence	C1	D x L1	H1	Poids (kg)	C	H
KX1-240 crose simple	108-0343	735	76 x 130	410	7	725	410

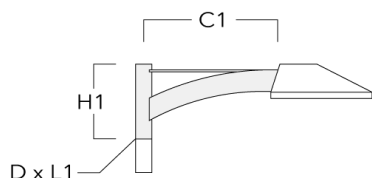

KX2-240 crose double	108-0534	735	76 x 130	410	11	725	410
----------------------	----------	-----	----------	-----	----	-----	-----

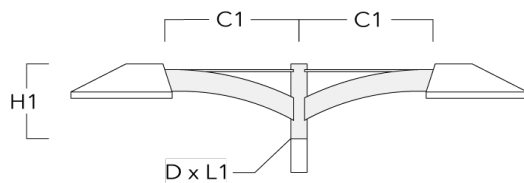

## Crosses pour mât KY

Description	Référence	A	C1	D x L1	H1	Poids (kg)	Alpha	C	H
KY1-240 crose simple réglable	108-0500	$\pm 30^\circ$	210	76 x 80	930	9.90	$+15^\circ / -30^\circ$	210	575

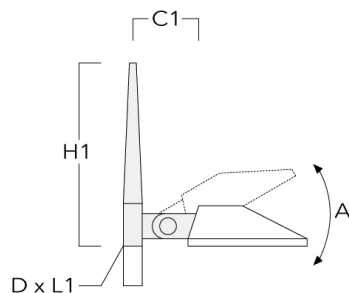

KY2-240 crose double réglable	108-0501	$\pm 30^\circ$	210	76 x 80	730	12.80	$+15^\circ / -30^\circ$	210	575
-------------------------------	----------	----------------	-----	---------	-----	-------	-------------------------	-----	-----

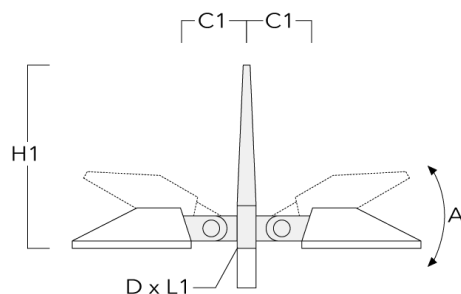

## Collier pour mâts SI

Description	Référence	C1	D1	Poids (kg)	C
SI1-240 collier de fixation (Ø 76-89)	108-0482	210	76-89	3.60	210

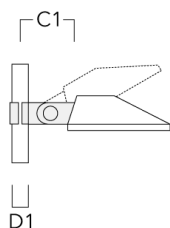

SI1-240 collier de fixation (Ø 114-133)	108-0483	210	114-133	4.40	210
---	----------	-----	---------	------	-----

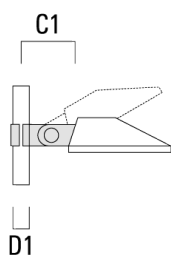

Description	Référence	C1	D1	Poids (kg)	C
SI1-240/260 collier de fixation (Ø 102-114)	108-0781	210	102-114	4	210

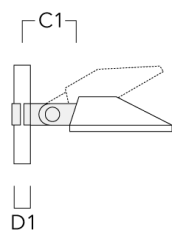

SI2-240 collier de fixation (Ø 76-89)	108-0484	210	76-89	5.20	210
---------------------------------------	----------	-----	-------	------	-----

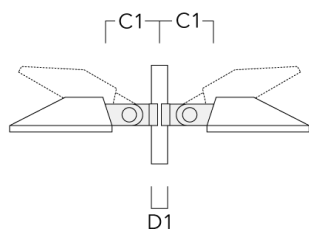

Description	Référence	C1	D1	Poids (kg)	C
SI2-240 collier de fixation (Ø 114-133)	108-0485	210	114-133	6.20	210

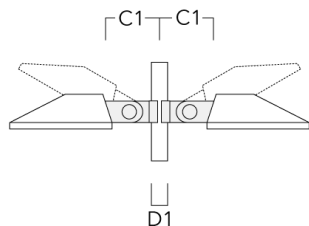

SI2-240/260 collier de fixation (Ø 102-114)	108-0783	210	102-114	5.70	210
---	----------	-----	---------	------	-----

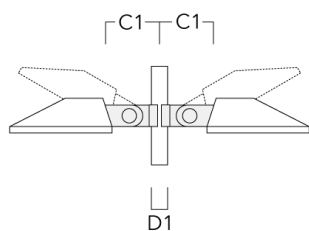

108-1699

PFL240 LED

**we-ef**

**Collier pour mâts SK**

Description	Référence	C1	D1	Poids (kg)	C
SK1-240 collier simple (Ø 102-114)	108-0782	175	102-114	3.40	175

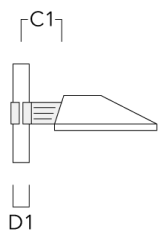

SK1-240 collier simple (Ø 76-89)	108-0788	175	76-89	3	175
----------------------------------	----------	-----	-------	---	-----

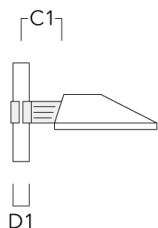

**WE-EF Switzerland AG**

Himmelrichstrasse 6, 6003 Luzern - Téléphone: +41 22 752 49 94

info.switzerland@we-ef.com - [https://we-ef.com/ch\\_fr](https://we-ef.com/ch_fr)

Sous réserve de modifications techniques et d'erreurs. - Généré le 23/11/2024

Description	Référence	C1	D1	Poids (kg)	C
SK1-240 collier simple (Ø 114-133)	108-0789	175	114-133	3.80	175

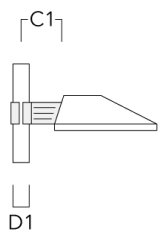

SK2-240 collier double (Ø 102-114)	108-0784	175	102-114	4.30	175
------------------------------------	----------	-----	---------	------	-----

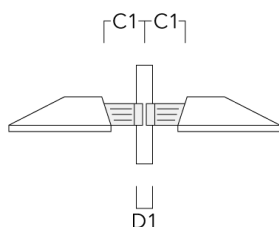



Description	Référence	C1	D1	Poids (kg)	C
SK2-240 collier double (Ø 76-89)	108-0790	175	76-89	3.90	175

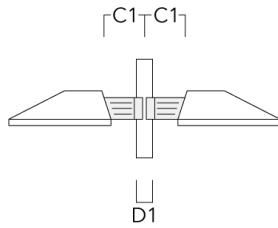

SK2-240 collier double (Ø 114-133)	108-0791	175	114-133	4.70	175
------------------------------------	----------	-----	---------	------	-----

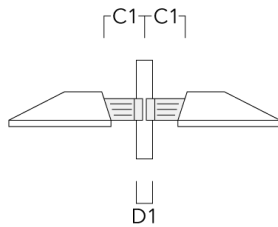

## Accessoires Optiques

### Light shield

Description	Référence	Informations complémentaires
LS180-[A60]	430-0038	Light shield LS180 to greatly reduce or eliminate light pollution. PA injection moulded component, black matt. Suitable for asymmetric light distribution [A60].
LS180	430-0029	Coupe-flux arrière adapté pour les optiques [S60], [S65], [S70], [R65], [P65]. Coupe-flux arrière assemblé sur le luminaire en usine ou disponible pour le rétrofit. Cela doit être déterminé à la commande.