



**Description**

IP66, Class I. IK08. Marine-grade die-cast aluminium alloy. 5CE superior corrosion protection + primer including PCS hardware. Silicone rubber gaskets. Safety glass lens, hinged. PMMA OLC® LED optics for superior illumination and glare control. Optional 2200 K version up to max. 1050mA available. To be specified at time of ordering. DALI.

A professional lighting design in consultation with the relevant sections of AS/NZS-1158.4:2015 is essential for all applications with the [P45] lens.

Please note that the luminaire requires a mounting bracket for installation. This bracket needs to be ordered separately. Please choose from one of our various options listed under Mounting Accessories

Weight	13.50 kg
Light distribution	asymmetric, side throw [S65]
Light source	LED-18/36W / 700 mA - 4000 K
CRI	80
Power supply	EC
LEDs	18
Rated input power	41 W

**Nominal Lumen (lm)**

LED Lumen	310
Total Lumen	5580
Tj	85

**Rated lumens (lm)**

LED Lumen	248.4
Total Lumen	4471.2
Ta	25

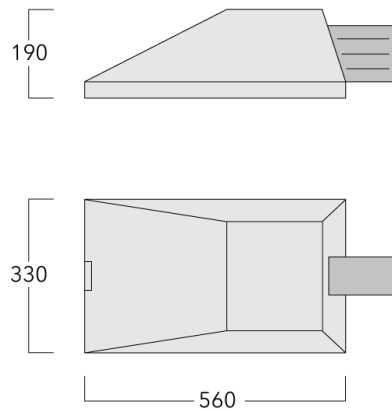

## Specifications

### Material description

Body	Marine-grade, die-cast aluminium alloy
Lens	Safety glass lens, hinged
Colours	<div style="display: flex; align-items: center;"> <div style="width: 20px; height: 15px; background-color: black; margin-right: 5px;"></div> <span>RAL9004 Signal black</span> </div> <div style="display: flex; align-items: center; margin-top: 5px;"> <div style="width: 20px; height: 15px; background-color: #cccccc; margin-right: 5px;"></div> <span>RAL9006 White aluminium</span> </div> <div style="display: flex; align-items: center; margin-top: 5px;"> <div style="width: 20px; height: 15px; background-color: #808080; margin-right: 5px;"></div> <span>RAL9007 Grey aluminium</span> </div>
Gasket	Silicone CCG® Controlled Compression Gasket
Fasteners	PCS Polymer Coated Stainless Steel Hardware (unpainted)
Ingress protection	IP66
Impact resistance	IK08
Corrosion resistance	5CE+Primer
Windage	0.075 m <sup>2</sup>

### Electrical description

Power supply	230V / 50 Hz
Driver / Ballast	Integral EC electronic converter. DALI
Power factor	> 0.9
Surge protection	In-pole surge protection SP10 device supplied. Please refer to WE-EF installation instructions for details. Use suffix +A for Integral surge protection.

#### WE-EF LIGHTING Pty Ltd

6/13 Downard Street, 3195 Braeside, Victoria - Phone: +61 3 8587 0444 - Fax: +61 3 8587 0499

info.australia@we-ef.com - <https://we-ef.com/aus>

Subject to technical changes and errors. - Generated on 23/11/2024

**108-1700**

**PFL240 LED**

**we-ef**

**Additional information**

---

Lifetime Ta=40° L90B10 > 90000h

Warranty The product is supplied with 10-year warranty. Please refer to the LED Warranty Statement located on [www.we-ef.com](http://www.we-ef.com) for further details.

---

**WE-EF LIGHTING Pty Ltd**

6/13 Downard Street, 3195 Braeside, Victoria - Phone: +61 3 8587 0444 - Fax: +61 3 8587 0499

info.australia@we-ef.com - <https://we-ef.com/aus>

Subject to technical changes and errors. - Generated on 23/11/2024

**108-1700**

**PFL240 LED**

**we-ef**

## **Control**

### **Eco Step Dim® Basic**

Description	Part ID
Eco Step Dim® Basic LED	430-0001

### **Eco Step Dim® Advanced**

Description	Part ID
Eco Step Dim® Advanced LED	430-0002

**WE-EF LIGHTING Pty Ltd**

6/13 Downard Street, 3195 Braeside, Victoria - Phone: +61 3 8587 0444 - Fax: +61 3 8587 0499

info.australia@we-ef.com - <https://we-ef.com/aus>

Subject to technical changes and errors. - Generated on 23/11/2024

**Mounting Accessories**

**Wall and pole brackets KI**

Description	Part ID	A	C1	D1	D2	H1	M1	Weight (kg)	Alpha	C	D	H
K10-240/260 Wall bracket	108-0493	±30°	210	180	140		12	5.70	±3°	210	180	180

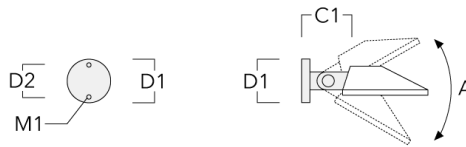

K11-240 Pole bracket, single	108-0491	±30°	210			525		6.90	+15° / -30°	210		525
------------------------------	----------	------	-----	--	--	-----	--	------	-------------	-----	--	-----

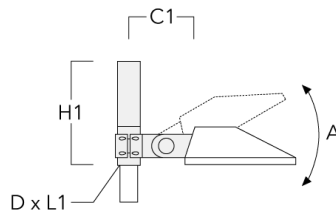

Description	Part ID	A	C1	D1	D2	H1	M1	Weight (kg)	Alpha	C	D	H
KI2-240 Pole bracket, double	108-0492	±30°	210			525		8.60	+15° / -30°	210		525

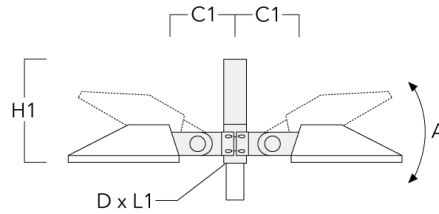

**Pole brackets KL**

Description	Part ID	C1	D x L1	H1	Weight (kg)	C	H
KL1-240 Pole bracket, single	108-0342	735	76 x 130	750	9	725	750

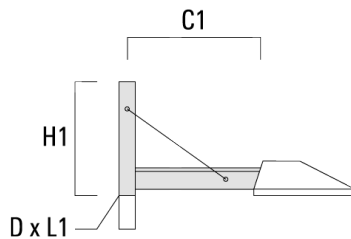

Description	Part ID	C1	D × L1	H1	Weight (kg)	C	H
KL2-240 Pole bracket, double	108-0532	735	76 x 130	750	14	725	750



**Wall and pole brackets KP**

Description	Part ID	C1	D1	D2	D × L1	H1	M1	Weight (kg)	C	D	H
KP0-240 Wall bracket	108-0103	200	230	195			12	2	175	230	230

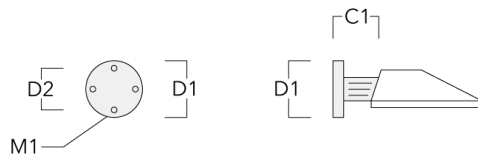

Description	Part ID	C1	D1	D2	D x L1	H1	M1	Weight (kg)	C	D	H
KP1-240 Pole bracket, single	108-0104	215			76 x 80	575		3.80	175		575



KP2-240 Pole bracket, double	108-0105	215			76 x 80	575		3.80	175		575
------------------------------	----------	-----	--	--	---------	-----	--	------	-----	--	-----





**Pole brackets KP\_L**

Description	Part ID	C1	D x L1	H1	Weight (kg)	C	H
KP1-L-240 Pole bracket, single	108-0268	635	76 x 130	575	9.10	175	575



KP2-L-240 Pole bracket, double	108-0373	635	76 x 130	575	15	175	575
--------------------------------	----------	-----	----------	-----	----	-----	-----



**Pole brackets KX**

Description	Part ID	C1	D x L1	H1	Weight (kg)	C	H
KX1-240 Pole bracket, single	108-0343	735	76 x 130	410	7	725	410

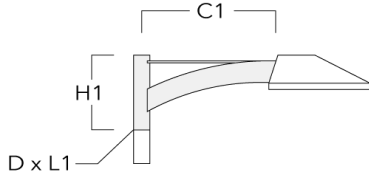

KX2-240 Pole bracket, double	108-0534	735	76 x 130	410	11	725	410
------------------------------	----------	-----	----------	-----	----	-----	-----

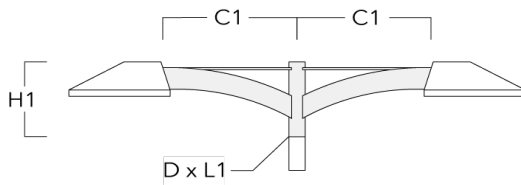

**Pole brackets KY**

Description	Part ID	A	C1	D x L1	H1	Weight (kg)	Alpha	C	H
KY1-240 Pole bracket, single	108-0500	±30°	210	76 x 80	930	9.90	+15° / -30°	210	575

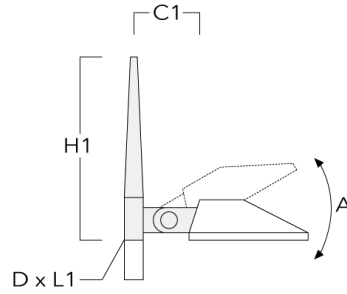

KY2-240 Pole bracket, double	108-0501	±30°	210	76 x 80	730	12.80	+15° / -30°	210	575
------------------------------	----------	------	-----	---------	-----	-------	-------------	-----	-----

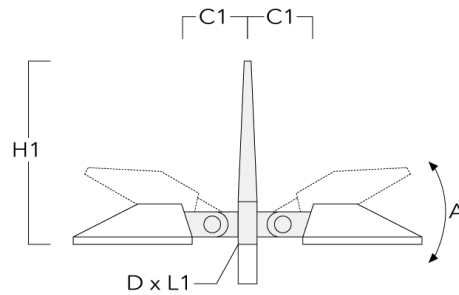

108-1700

PFL240 LED

**we-ef**

**Pole clamp SI**

Description	Part ID	C1	D1	Weight (kg)	C
SI1-240/260 Pole clamp, single (Ø 76-89)	108-0482	210	76-89	3.60	210



SI1-240/260 Pole clamp, single (Ø 114-133)	108-0483	210	114-133	4.40	210
--	----------	-----	---------	------	-----

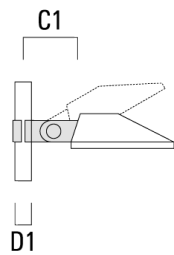

**WE-EF LIGHTING Pty Ltd**

6/13 Downard Street, 3195 Braeside, Victoria - Phone: +61 3 8587 0444 - Fax: +61 3 8587 0499

info.australia@we-ef.com - <https://we-ef.com/aus>

Subject to technical changes and errors. - Generated on 23/11/2024

**PFL240 LED**

Description	Part ID	C1	D1	Weight (kg)	C
SI1-240/260 Pole clamp, single (Ø 102-114)	108-0781	210	102-114	4	210



SI2-240/260 Pole clamp, double (Ø 76-89)	108-0484	210	76-89	5.20	210
--	----------	-----	-------	------	-----



**PFL240 LED**

Description	Part ID	C1	D1	Weight (kg)	C
SI2-240/260 Pole clamp, double (Ø 114-133)	108-0485	210	114-133	6.20	210



SI2-240/260 Pole clamp, double (Ø 102-114)	108-0783	210	102-114	5.70	210
--	----------	-----	---------	------	-----



108-1700

PFL240 LED

**we-ef**

**Pole clamp SK**

Description	Part ID	C1	D1	Weight (kg)	C
SK1-240 Pole clamp, single (Ø 102-114)	108-0782	175	102-114	3.40	175

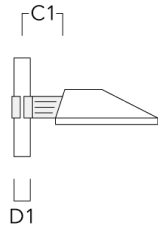

SK1-240 Pole clamp, single (Ø 76-89)	108-0788	175	76-89	3	175
--------------------------------------	----------	-----	-------	---	-----



Description	Part ID	C1	D1	Weight (kg)	C
SK1-240 Pole clamp, single (Ø 114-133)	108-0789	175	114-133	3.80	175



SK2-240 Pole clamp, double (Ø 102-114)	108-0784	175	102-114	4.30	175
--	----------	-----	---------	------	-----





Description	Part ID	C1	D1	Weight (kg)	C
SK2-240 Pole clamp, double (Ø 76-89)	108-0790	175	76-89	3.90	175



SK2-240 Pole clamp, double (Ø 114-133)	108-0791	175	114-133	4.70	175
--	----------	-----	---------	------	-----



**108-1700**

**PFL240 LED**

**we-ef**

## **Optical Accessories**

### **Light shield**

Description	Part ID	Additional information
LS180-[A60]	003-4018	Glare Shield for backlight spill. Glare Shield factory-installed or available as retrofit kit. Suitable for [A60] lenses. Must be specified at time of ordering.
LS180	003-4019	Glare Shield for backlight spill. Glare Shield factory-installed or available as retrofit kit. Suitable for [S60], [S65], [S70], [R65], [P65] lenses. Must be specified at time of ordering.

**WE-EF LIGHTING Pty Ltd**

6/13 Downard Street, 3195 Braeside, Victoria - Phone: +61 3 8587 0444 - Fax: +61 3 8587 0499

info.australia@we-ef.com - <https://we-ef.com/aus>

Subject to technical changes and errors. - Generated on 23/11/2024