

108-1700

PFL240 LED

**we-ef**



### Beschreibung

IP66, SKI. SKII auf Anfrage. IK08. Korrosionsbeständiger Aluminiumguss. PCS beschichtete Edelstahlschrauben. 5CE Korrosionsschutz. CCG® Silikondichtung. Sicherheitsglas, abklappbar. CAD-optimierte OLC® Technik zur Lichtlenkung und Entblendung.

Variante mit 2200 K bis max. 1050 mA erhältlich, bei Bestellung bitte angeben.

Ausleger sind separat zu bestellen.

|                    |                                   |
|--------------------|-----------------------------------|
| Gewicht            | 13.50 kg                          |
| Lichtverteilung    | asymmetric, side throw beam [S65] |
| Lichtquelle        | LED-18/36W / 700 mA - 4000 K      |
| CRI                | 80                                |
| Netz               | EVG                               |
| LEDs               | 18                                |
| Bemessungsleistung | 41 W                              |

### Nominal Lichtstrom (lm)

|             |      |
|-------------|------|
| LED Lumen   | 310  |
| Total Lumen | 5580 |
| Tj          | 85   |

### Bemessungslichtstrom (lm)

|             |        |
|-------------|--------|
| LED Lumen   | 248.4  |
| Total Lumen | 4471.2 |
| Ta          | 25     |

### WE-EF Switzerland AG

Himmelrichstrasse 6, 6003 Luzern - Tel: +41 41 210 49 95

info.switzerland@we-ef.com - [https://we-ef.com/ch\\_de](https://we-ef.com/ch_de)

Technische Änderungen und Irrtümer vorbehalten. - Erstellt am 23.11.2024

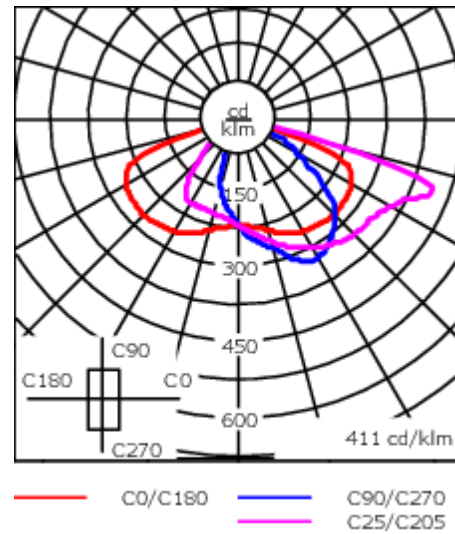
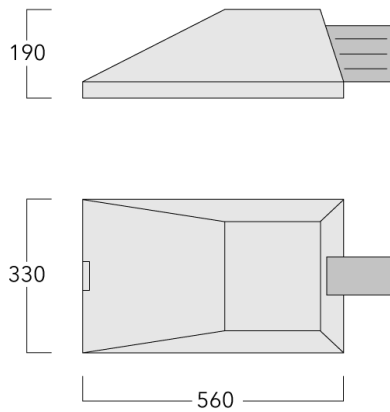

## Spezifikationen

### Materialbeschreibung

|                         |   |
|-------------------------|---|
| Gehäuse                 | Korrosionsbeständiger Aluminiumguss   |
| Abdeckung               | Sicherheitsglas, abklappbar   |
| Farben                  | <div style="display: flex; align-items: center;"> <div style="width: 20px; height: 10px; background-color: black; margin-right: 5px;"></div> <span>RAL9004 Signalschwarz</span> </div> <div style="display: flex; align-items: center; margin-top: 5px;"> <div style="width: 20px; height: 10px; background-color: gray; margin-right: 5px;"></div> <span>RAL9007 Graualuminium</span> </div> <div style="display: flex; align-items: center; margin-top: 5px;"> <div style="width: 20px; height: 10px; background-color: darkgray; margin-right: 5px;"></div> <span>RAL7016 Anthrazitgrau</span> </div> <div style="display: flex; align-items: center; margin-top: 5px;"> <div style="width: 20px; height: 10px; background-color: lightgray; margin-right: 5px;"></div> <span>RAL9016 Verkehrsweiß</span> </div> |
| Dichtung                | CCG® Silikondichtung  |
| Schrauben               | PCS beschichtete Edelstahlschrauben   |
| Schutzart               | IP66  |
| Schlagfestigkeit        | IK08  |
| Korrosionsbeständigkeit | 5CE   |
| Windangriffsfläche      | 0.075 m <sup>2</sup>  |

### Elektrische Beschreibung

|                               |   |
|-------------------------------|---|
| Netz                          | 220-240V / 50-60 Hz                           |
| Netzgerät /<br>Vorschaltgerät | Eingebaute elektronische Betriebsgeräte. DALI |
| Leistungsfaktor               | > 0.9   |

#### WE-EF Switzerland AG

**108-1700**

**PFL240 LED**

**we-ef**

### **Weitere Informationen**

---

Lebensdauer Ta=25° L90B10 > 90000h

Energieeffizienzklasse C-D (Lichtquelle)

---

**WE-EF Switzerland AG**

Himmelrichstrasse 6, 6003 Luzern - Tel: +41 41 210 49 95

info.switzerland@we-ef.com - [https://we-ef.com/ch\\_de](https://we-ef.com/ch_de)

Technische Änderungen und Irrtümer vorbehalten. - Erstellt am 23.11.2024

**108-1700**

**PFL240 LED**

**we-ef**

## **Steuerung**

### **Eco Step Dim® Basic**

| Beschreibung            | Artikelnummer |
|-------------------------|---------------|
| Eco Step Dim® Basic LED | 430-0001      |

### **Eco Step Dim® Advanced**

| Beschreibung               | Artikelnummer |
|----------------------------|---------------|
| Eco Step Dim® Advanced LED | 430-0002      |

#### **WE-EF Switzerland AG**

Himmelrichstrasse 6, 6003 Luzern - Tel: +41 41 210 49 95

info.switzerland@we-ef.com - [https://we-ef.com/ch\\_de](https://we-ef.com/ch_de)

Technische Änderungen und Irrtümer vorbehalten. - Erstellt am 23.11.2024

**Montagezubehör**

**Wand- und Mastausleger KI**

| Beschreibung             | Artikelnummer | A    | C1  | D1  | D2  | H1 | M1 | Gewicht (kg) | Alpha | C   | D   | H   |
|--------------------------|---------------|------|-----|-----|-----|----|----|--------------|-------|-----|-----|-----|
| KI0-240/260 Wandausleger | 108-0493      | ±30° | 210 | 180 | 140 |    | 12 | 5.70         | ±3°   | 210 | 180 | 180 |

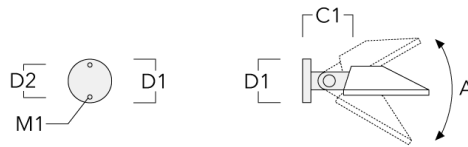

|                               |          |      |     |  |  |     |  |      |             |     |  |     |
|-------------------------------|----------|------|-----|--|--|-----|--|------|-------------|-----|--|-----|
| KI1-240 Mastausleger, einfach | 108-0491 | ±30° | 210 |  |  | 525 |  | 6.90 | +15° / -30° | 210 |  | 525 |
|-------------------------------|----------|------|-----|--|--|-----|--|------|-------------|-----|--|-----|

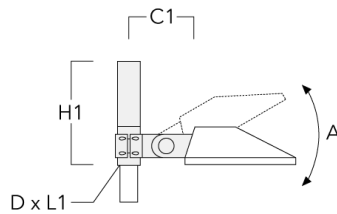

| Beschreibung                   | Artikelnummer | A              | C1  | D1 | D2 | H1  | M1 | Gewicht (kg) | Alpha                   | C   | D | H   |
|--------------------------------|---------------|----------------|-----|----|----|-----|----|--------------|-------------------------|-----|---|-----|
| KI2-240 Mastausleger, zweifach | 108-0492      | $\pm 30^\circ$ | 210 |    |    | 525 |    | 8.60         | $+15^\circ / -30^\circ$ | 210 |   | 525 |

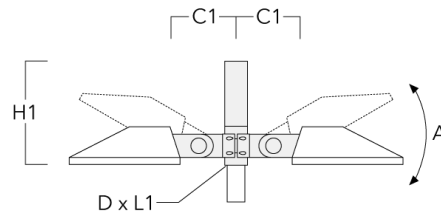

### Mastausleger KL

| Beschreibung                  | Artikelnummer | C1  | D x L1   | H1  | Gewicht (kg) | C   | H   |
|-------------------------------|---------------|-----|----------|-----|--------------|-----|-----|
| KL1-240 Mastausleger, einfach | 108-0342      | 735 | 76 x 130 | 750 | 9            | 725 | 750 |

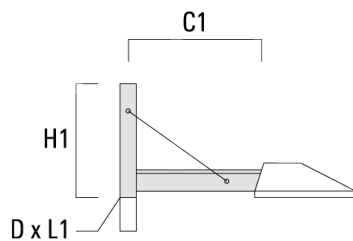

| Beschreibung                   | Artikelnummer | C1  | D × L1   | H1  | Gewicht (kg) | C   | H   |
|--------------------------------|---------------|-----|----------|-----|--------------|-----|-----|
| KL2-240 Mastausleger, zweifach | 108-0532      | 735 | 76 x 130 | 750 | 14           | 725 | 750 |

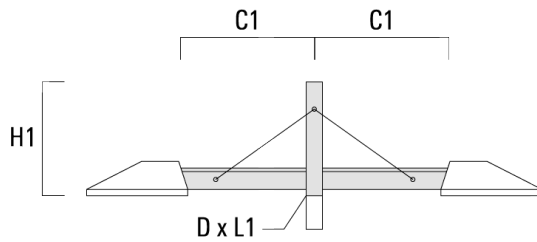

### Wand- und Mastausleger KP

| Beschreibung         | Artikelnummer | C1  | D1  | D2  | D × L1 | H1 | M1 | Gewicht (kg) | C   | D   | H   |
|----------------------|---------------|-----|-----|-----|--------|----|----|--------------|-----|-----|-----|
| KP0-240 Wandausleger | 108-0103      | 200 | 230 | 195 |        |    | 12 | 2            | 175 | 230 | 230 |

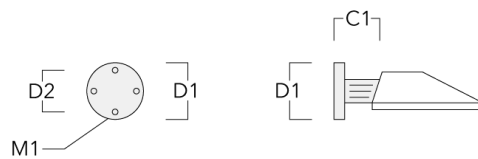

| Beschreibung                  | Artikelnummer | C1  | D1 | D2 | D x L1  | H1  | M1 | Gewicht (kg) | C   | D | H   |
|-------------------------------|---------------|-----|----|----|---------|-----|----|--------------|-----|---|-----|
| KP1-240 Mastausleger, einfach | 108-0104      | 215 |    |    | 76 x 80 | 575 |    | 3.80         | 175 |   | 575 |

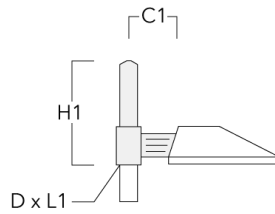

|                                |          |     |  |  |         |     |  |      |     |  |     |
|--------------------------------|----------|-----|--|--|---------|-----|--|------|-----|--|-----|
| KP2-240 Mastausleger, zweifach | 108-0105 | 215 |  |  | 76 x 80 | 575 |  | 3.80 | 175 |  | 575 |
|--------------------------------|----------|-----|--|--|---------|-----|--|------|-----|--|-----|

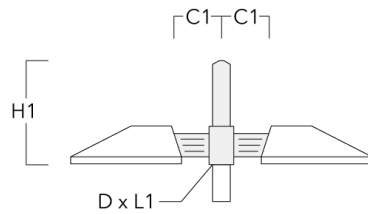



**Mastausleger KP\_L**

| Beschreibung                    | Artikelnummer | C1  | D x L1   | H1  | Gewicht (kg) | C   | H   |
|---------------------------------|---------------|-----|----------|-----|--------------|-----|-----|
| KP1-L-240 Mastausleger, einfach | 108-0268      | 635 | 76 x 130 | 575 | 9.10         | 175 | 575 |

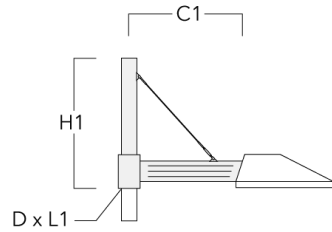

|                                  |          |     |          |     |    |     |     |
|----------------------------------|----------|-----|----------|-----|----|-----|-----|
| KP2-L-240 Mastausleger, zweifach | 108-0373 | 635 | 76 x 130 | 575 | 15 | 175 | 575 |
|----------------------------------|----------|-----|----------|-----|----|-----|-----|

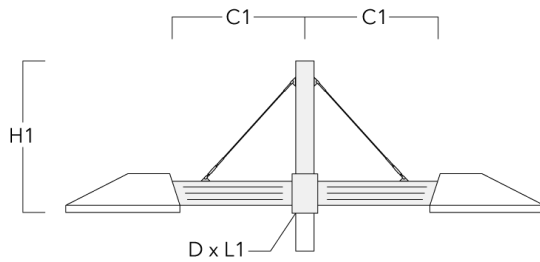

## Mastausleger KX

| Beschreibung                  | Artikelnummer | C1  | D x L1   | H1  | Gewicht (kg) | C   | H   |
|-------------------------------|---------------|-----|----------|-----|--------------|-----|-----|
| KX1-240 Mastausleger, einfach | 108-0343      | 735 | 76 x 130 | 410 | 7            | 725 | 410 |

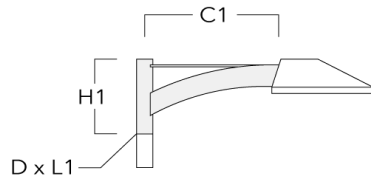

|                                |          |     |          |     |    |     |     |
|--------------------------------|----------|-----|----------|-----|----|-----|-----|
| KX2-240 Mastausleger, zweifach | 108-0534 | 735 | 76 x 130 | 410 | 11 | 725 | 410 |
|--------------------------------|----------|-----|----------|-----|----|-----|-----|

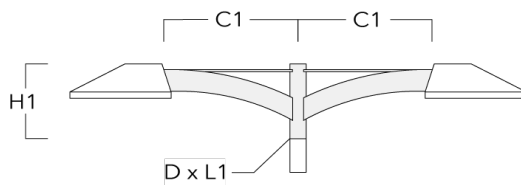

**Mastausleger KY**

| Beschreibung                  | Artikelnummer | A    | C1  | D x L1  | H1  | Gewicht (kg) | Alpha       | C   | H   |
|-------------------------------|---------------|------|-----|---------|-----|--------------|-------------|-----|-----|
| KY1-240 Mastausleger, einfach | 108-0500      | ±30° | 210 | 76 x 80 | 930 | 9.90         | +15° / -30° | 210 | 575 |

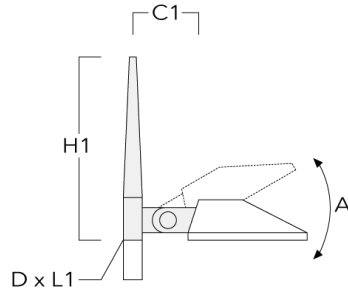

|                                |          |      |     |         |     |       |             |     |     |
|--------------------------------|----------|------|-----|---------|-----|-------|-------------|-----|-----|
| KY2-240 Mastausleger, zweifach | 108-0501 | ±30° | 210 | 76 x 80 | 730 | 12.80 | +15° / -30° | 210 | 575 |
|--------------------------------|----------|------|-----|---------|-----|-------|-------------|-----|-----|

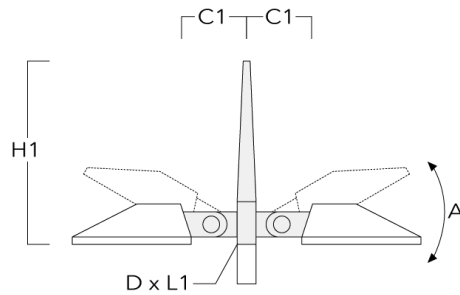

## Mastschellen SI

| Beschreibung                               | Artikelnummer | C1  | D1    | Gewicht (kg) | C   |
|--|---------------|-----|-------|--------------|-----|
| SI1-240/260 Mastschelle, einfach (Ø 76-89) | 108-0482      | 210 | 76-89 | 3.60         | 210 |

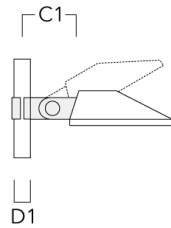

|  |          |     |         |      |     |
|--|----------|-----|---------|------|-----|
| SI1-240/260 Mastschelle, einfach (Ø 114-133) | 108-0483 | 210 | 114-133 | 4.40 | 210 |
|--|----------|-----|---------|------|-----|

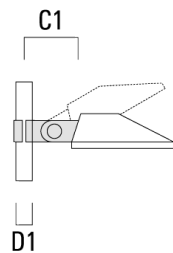

| Beschreibung                                 | Artikelnummer | C1  | D1      | Gewicht (kg) | C   |
|--|---------------|-----|---------|--------------|-----|
| SI1-240/260 Mastschelle, einfach (Ø 102-114) | 108-0781      | 210 | 102-114 | 4            | 210 |

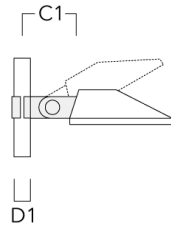

|   |          |     |       |      |     |
|---|----------|-----|-------|------|-----|
| SI2-240/260 Mastschelle, zweifach (Ø 76-89) | 108-0484 | 210 | 76-89 | 5.20 | 210 |
|---|----------|-----|-------|------|-----|

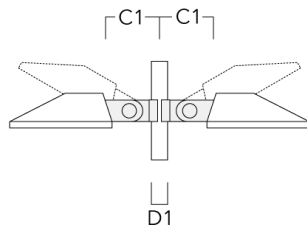

| Beschreibung                                  | Artikelnummer | C1  | D1      | Gewicht (kg) | C   |
|---|---------------|-----|---------|--------------|-----|
| SI2-240/260 Mastschelle, zweifach (Ø 114-133) | 108-0485      | 210 | 114-133 | 6.20         | 210 |

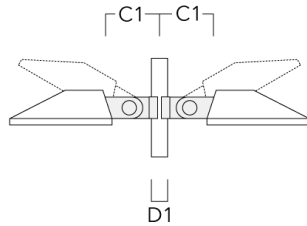

|   |          |     |         |      |     |
|---|----------|-----|---------|------|-----|
| SI2-240/260 Mastschelle, zweifach (Ø 102-114) | 108-0783 | 210 | 102-114 | 5.70 | 210 |
|---|----------|-----|---------|------|-----|

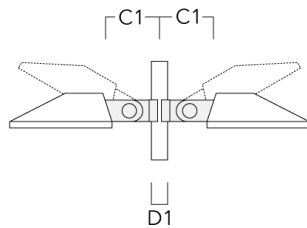

**Mastschellen SK**

| Beschreibung                             | Artikelnummer | C1  | D1      | Gewicht (kg) | C   |
|--|---------------|-----|---------|--------------|-----|
| SK1-240 Mastschelle, einfach (Ø 102-114) | 108-0782      | 175 | 102-114 | 3.40         | 175 |

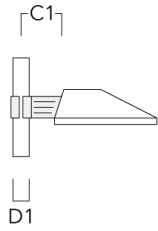

|  |          |     |       |   |     |
|--|----------|-----|-------|---|-----|
| SK1-240 Mastschelle, einfach (Ø 76-89) | 108-0788 | 175 | 76-89 | 3 | 175 |
|--|----------|-----|-------|---|-----|

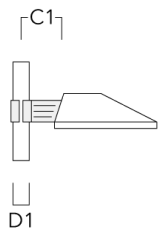

| Beschreibung                             | Artikelnummer | C1  | D1      | Gewicht (kg) | C   |
|--|---------------|-----|---------|--------------|-----|
| SK1-240 Mastschelle, einfach (Ø 114-133) | 108-0789      | 175 | 114-133 | 3.80         | 175 |

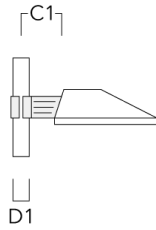

|   |          |     |         |      |     |
|---|----------|-----|---------|------|-----|
| SK2-240 Mastschelle, zweifach (Ø 102-114) | 108-0784 | 175 | 102-114 | 4.30 | 175 |
|---|----------|-----|---------|------|-----|

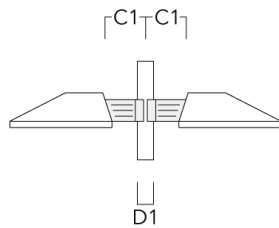



| Beschreibung                            | Artikelnummer | C1  | D1    | Gewicht (kg) | C   |
|---|---------------|-----|-------|--------------|-----|
| SK2-240 Mastschelle, zweifach (Ø 76-89) | 108-0790      | 175 | 76-89 | 3.90         | 175 |

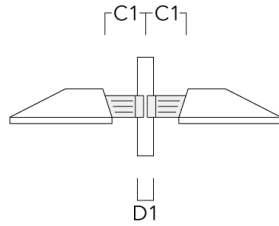

|   |          |     |         |      |     |
|---|----------|-----|---------|------|-----|
| SK2-240 Mastschelle, zweifach (Ø 114-133) | 108-0791 | 175 | 114-133 | 4.70 | 175 |
|---|----------|-----|---------|------|-----|

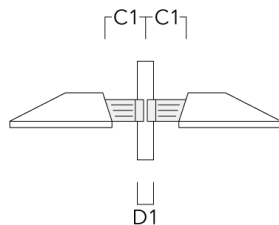

**Optisches Zubehör****Blendschutz**

| Beschreibung | Artikelnummer | Weitere Informationen  |
|--------------|---------------|--|
| LS180-[A60]  | 430-0038      | Blende LS180 zur Reduktion des rückseitigen Streulichts oder Beseitigung von Lichtimmissionen.<br>PA Spritzguss-Komponente, matt schwarz.<br>Geeignet für asymmetrische Lichtverteilung [A60].   |
| LS180        | 430-0029      | Blendschutz zur Reduktion des rückseitigen Streulichts.<br>Blendschutz werkseitig eingebaut oder als Nachrüstsatz erhältlich.<br>Geeignet für asymmetrische Lichtverteilung [S60], [S65], [S70], [R65], [P65], bei Bestellung bitte angeben. |