

108-1690

PFL240 LED

we-ef



Description

IP66, Class I. Class II on request. IK08. Marine-grade die-cast aluminium alloy. 5CE superior corrosion protection including PCS hardware. Silicone CCG® Controlled Compression Gasket. Safety glass lens, hinged. PMMA OLC® optics for superior illumination and glare control.

Optional 2200 K version up to max. 1050mA available. To be specified at time of ordering.

Brackets to be ordered separately.

Weight	13.50 kg
Light distribution	rectangular, side throw [R65]
Light source	LED-18/54W / 1050 mA - 4000 K
CRI	80
Power supply	EC
LEDs	18
Rated input power	59 W

Nominal Lumen (lm)

LED Lumen	450
Total Lumen	8100
Tj	85

Rated lumens (lm)

LED Lumen	328.5
Total Lumen	5913.1
Ta	25

Fagerhult Lighting Ltd

33-34 Dolben Street, SE1 0UQ London, United Kingdom

<https://we-ef.com/uk>

Subject to technical changes and errors. - Generated on 23/11/2024

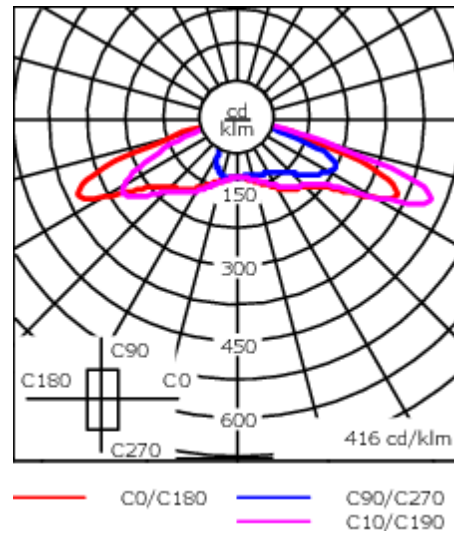
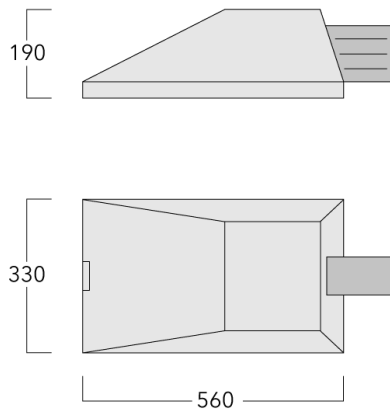

Specifications

Material description

Body	Marine-grade, die-cast aluminium alloy
Lens	Safety glass lens, hinged
Colours	<div style="display: flex; align-items: center;"> <div style="width: 20px; height: 15px; background-color: black; margin-right: 5px;"></div> RAL9004 Signal black </div> <div style="display: flex; align-items: center; margin-top: 5px;"> <div style="width: 20px; height: 15px; background-color: #cccccc; margin-right: 5px;"></div> RAL9006 White aluminium </div> <div style="display: flex; align-items: center; margin-top: 5px;"> <div style="width: 20px; height: 15px; background-color: #808080; margin-right: 5px;"></div> RAL9007 Grey aluminium </div> <div style="display: flex; align-items: center; margin-top: 5px;"> <div style="width: 20px; height: 15px; background-color: #333333; margin-right: 5px;"></div> RAL7016 Anthracite grey </div> <div style="display: flex; align-items: center; margin-top: 5px;"> <div style="width: 20px; height: 15px; background-color: #e0e0e0; margin-right: 5px;"></div> RAL9016 Traffic white </div>
Gasket	Silicone CCG® Controlled Compression Gasket
Fasteners	PCS Polymer Coated Stainless Steel Hardware
Ingress protection	IP66
Impact resistance	IK08
Corrosion resistance	5CE
Windage	0.075 m ²

Electrical description

Power supply	220-240V / 50-60 Hz
Driver / Ballast	Integral EC electronic converter. DALI
Power factor	> 0.9
Surge protection	6/6 kV (optional SP10)

108-1690

PFL240 LED

we-ef

Additional information

Lifetime Ta=25° L90B10 > 90000h

Energy efficiency class C-D (Light source)

Fagerhult Lighting Ltd

33-34 Dolben Street, SE1 0UQ London, United Kingdom

<https://we-ef.com/uk>

Subject to technical changes and errors. - Generated on 23/11/2024

108-1690

PFL240 LED

we-ef

Control

Eco Step Dim® Basic

Description	Part ID
Eco Step Dim® Basic LED	430-0001

Eco Step Dim® Advanced

Description	Part ID
Eco Step Dim® Advanced LED	430-0002

Fagerhult Lighting Ltd

33-34 Dolben Street, SE1 0UQ London, United Kingdom

<https://we-ef.com/uk>

Subject to technical changes and errors. - Generated on 23/11/2024

Mounting Accessories

Wall and pole brackets KI

Description	Part ID	A	C1	D1	D2	H1	M1	Weight (kg)	Alpha	C	D	H
KI0-240/260 Wall bracket	108-0493	±30°	210	180	140		12	5.70	±3°	210	180	180

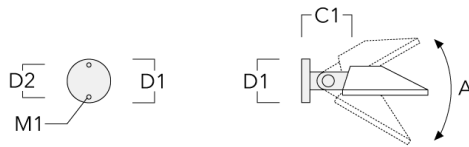

KI1-240 Pole bracket, single	108-0491	±30°	210			525		6.90	+15° / -30°	210		525
------------------------------	----------	------	-----	--	--	-----	--	------	-------------	-----	--	-----

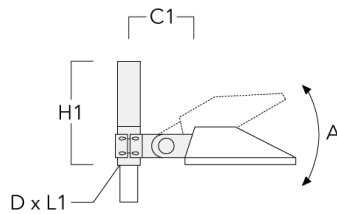

PFL240 LED

Description	Part ID	A	C1	D1	D2	H1	M1	Weight (kg)	Alpha	C	D	H
KI2-240 Pole bracket, double	108-0492	±30°	210			525		8.60	+15° / -30°	210		525

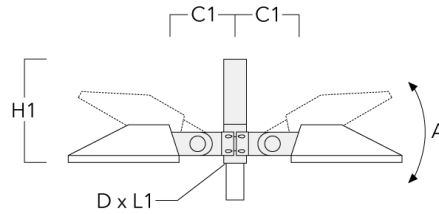

Pole brackets KL

Description	Part ID	C1	D x L1	H1	Weight (kg)	C	H
KL1-240 Pole bracket, single	108-0342	735	76 x 130	750	9	725	750

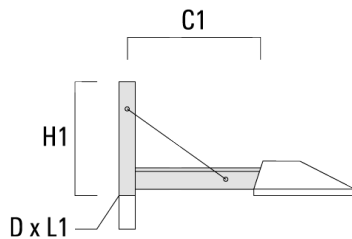

Description	Part ID	C1	D × L1	H1	Weight (kg)	C	H
KL2-240 Pole bracket, double	108-0532	735	76 x 130	750	14	725	750

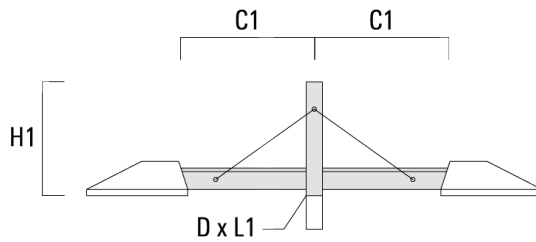

Wall and pole brackets KP

Description	Part ID	C1	D1	D2	D × L1	H1	M1	Weight (kg)	C	D	H
KP0-240 Wall bracket	108-0103	200	230	195			12	2	175	230	230

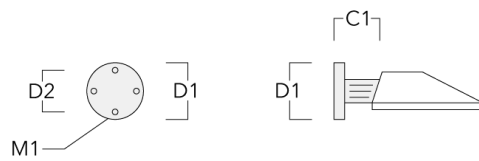

Description	Part ID	C1	D1	D2	D × L1	H1	M1	Weight (kg)	C	D	H
KP1-240 Pole bracket, single	108-0104	215			76 x 80	575		3.80	175		575

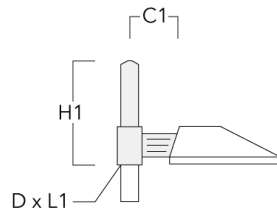

KP2-240 Pole bracket, double	108-0105	215			76 x 80	575		3.80	175		575
------------------------------	----------	-----	--	--	---------	-----	--	------	-----	--	-----

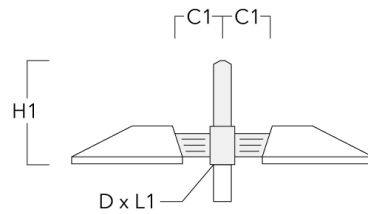

Pole brackets KP_L

Description	Part ID	C1	D x L1	H1	Weight (kg)	C	H
KP1-L-240 Pole bracket, single	108-0268	635	76 x 130	575	9.10	175	575

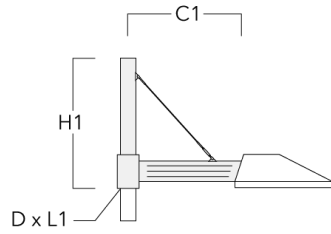

KP2-L-240 Pole bracket, double	108-0373	635	76 x 130	575	15	175	575
--------------------------------	----------	-----	----------	-----	----	-----	-----

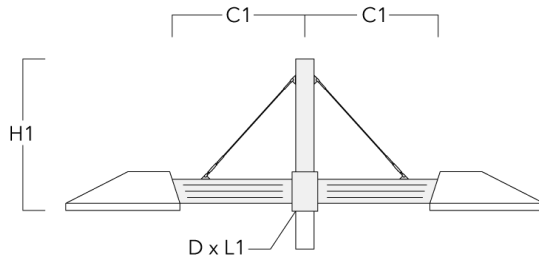

Pole brackets KX

Description	Part ID	C1	D × L1	H1	Weight (kg)	C	H
KX1-240 Pole bracket, single	108-0343	735	76 x 130	410	7	725	410

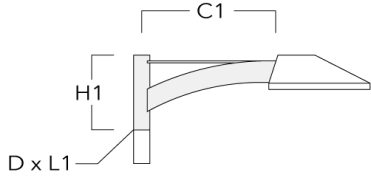

KX2-240 Pole bracket, double	108-0534	735	76 x 130	410	11	725	410
------------------------------	----------	-----	----------	-----	----	-----	-----

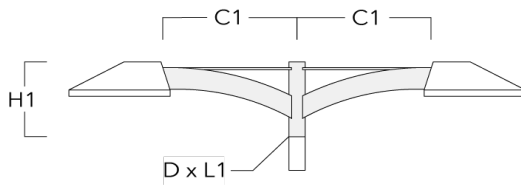

Pole brackets KY

Description	Part ID	A	C1	D x L1	H1	Weight (kg)	Alpha	C	H
KY1-240 Pole bracket, single	108-0500	±30°	210	76 x 80	930	9.90	+15° / -30°	210	575

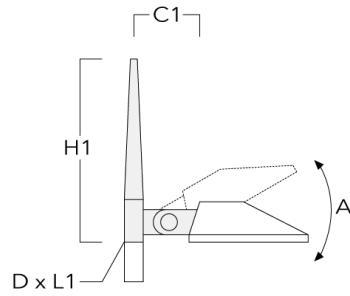

KY2-240 Pole bracket, double	108-0501	±30°	210	76 x 80	730	12.80	+15° / -30°	210	575
------------------------------	----------	------	-----	---------	-----	-------	-------------	-----	-----

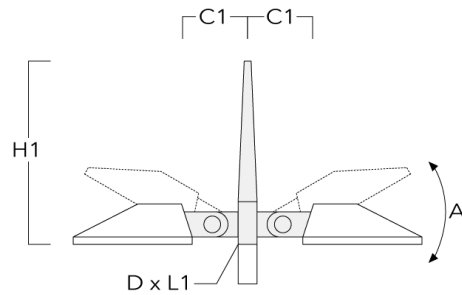

108-1690

PFL240 LED

we-ef

Pole clamp SI

Description	Part ID	C1	D1	Weight (kg)	C
SI1-240/260 Pole clamp, single (Ø 76-89)	108-0482	210	76-89	3.60	210

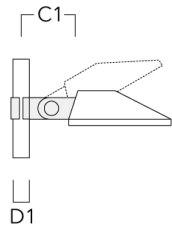

SI1-240/260 Pole clamp, single (Ø 114-133)	108-0483	210	114-133	4.40	210
--------------------------------------------	----------	-----	---------	------	-----

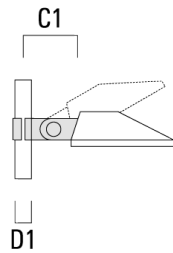

108-1690

PFL240 LED

we-ef

Description	Part ID	C1	D1	Weight (kg)	C
SI1-240/260 Pole clamp, single (Ø 102-114)	108-0781	210	102-114	4	210

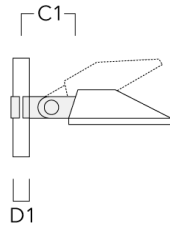

SI2-240/260 Pole clamp, double (Ø 76-89)	108-0484	210	76-89	5.20	210
------------------------------------------	----------	-----	-------	------	-----

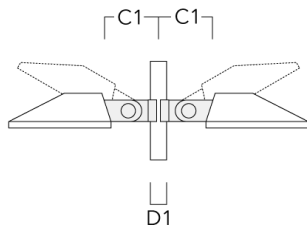

Fagerhult Lighting Ltd

33-34 Dolben Street, SE1 0UQ London, United Kingdom

<https://we-ef.com/uk>

Subject to technical changes and errors. - Generated on 23/11/2024

108-1690

PFL240 LED

we-ef

Description	Part ID	C1	D1	Weight (kg)	C
SI2-240/260 Pole clamp, double (Ø 114-133)	108-0485	210	114-133	6.20	210

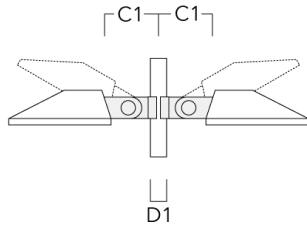

SI2-240/260 Pole clamp, double (Ø 102-114)	108-0783	210	102-114	5.70	210
--------------------------------------------	----------	-----	---------	------	-----

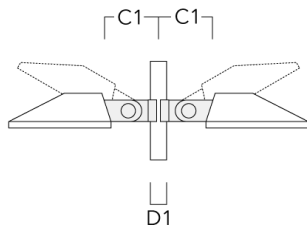

108-1690

PFL240 LED

we-ef

Pole clamp SK

Description	Part ID	C1	D1	Weight (kg)	C
SK1-240 Pole clamp, single (Ø 102-114)	108-0782	175	102-114	3.40	175

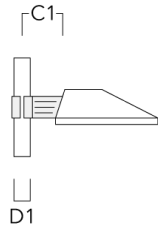

SK1-240 Pole clamp, single (Ø 76-89)	108-0788	175	76-89	3	175
--------------------------------------	----------	-----	-------	---	-----

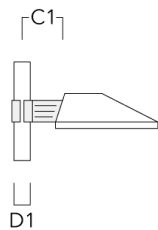

108-1690

PFL240 LED

we-ef

Description	Part ID	C1	D1	Weight (kg)	C
SK1-240 Pole clamp, single (Ø 114-133)	108-0789	175	114-133	3.80	175

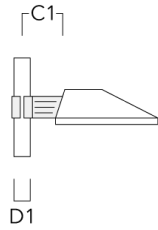

SK2-240 Pole clamp, double (Ø 102-114)	108-0784	175	102-114	4.30	175
----------------------------------------	----------	-----	---------	------	-----

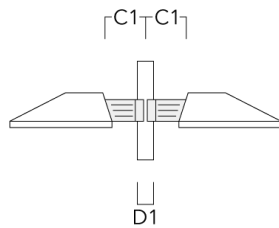

Fagerhult Lighting Ltd

33-34 Dolben Street, SE1 0UQ London, United Kingdom

<https://we-ef.com/uk>

Subject to technical changes and errors. - Generated on 23/11/2024

108-1690

PFL240 LED

we-ef

Description	Part ID	C1	D1	Weight (kg)	C
SK2-240 Pole clamp, double (Ø 76-89)	108-0790	175	76-89	3.90	175

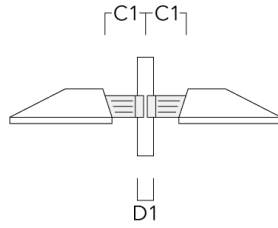

SK2-240 Pole clamp, double (Ø 114-133)	108-0791	175	114-133	4.70	175
----------------------------------------	----------	-----	---------	------	-----

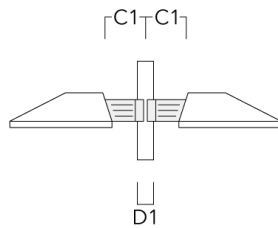

108-1690

PFL240 LED

we-ef

Optical Accessories

Light shield

Description	Part ID	Additional information
LS180-[A60]	430-0038	Light shield LS180 to greatly reduce or eliminate light pollution. PA injection moulded component, black matt. Suitable for asymmetric light distribution [A60].
LS180	430-0029	Glare Shield for backlight spill. Glare Shield factory-installed or available as retrofit kit. Suitable for [S60], [S65], [S70], [R65], [P65] lenses. Must be specified at time of ordering.