

108-1639

PFL240 LED

we-ef



Description

IP66. Class I. IK08. Marine-grade, die-cast aluminum alloy. 5CE superior corrosion protection including PCS hardware. Silicone CCG® Controlled Compression Gasket. Safety glass lens, hinged frame. Luminaire is factory-wired and supplied with 30' of black, three conductor, flexible SEOW cord for power connection at pole-base hand hole. PMMA optics for superior illumination and glare control. OLC® One LED Concept. 0-10V Dimming comes standard with luminaire.

Recommended mounting height 10-30 ft, depending on wattage selected; mounting bracket required.

Specify product with 7 Digit product code - Finish Color. Accessories, such as mounting, optical, and electrical, must be specified separately.

Example: XXX-XXXX-9004 (Black)
+ XXX-XXXX (Accessory 1)

Weight	33.00 lb
Light distribution	[R65] Type IV Medium
Light source	LED-24/72W / 1050 mA - 4000 K
CRI	80
Power supply	electronic gear
BUG	B2 U0 G2
LEDs	24
Rated input power	81 W

Nominal Lumen (lm)

LED Lumen	450
Total Lumen	10800
Tj	85

Rated lumens (lm)

LED Lumen	328.5
Total Lumen	7884.2
Ta	25

WE-EF LIGHTING USA, LLC

410-D Keystone Drive, 15086 Warrendale, PA 15086 - Phone: +1 724 742 0030
customersupport.usa@we-ef.com - <https://we-ef.com/us>
Subject to technical changes and errors. - Generated on 11/23/2024

108-1639

PFL240 LED

we-ef

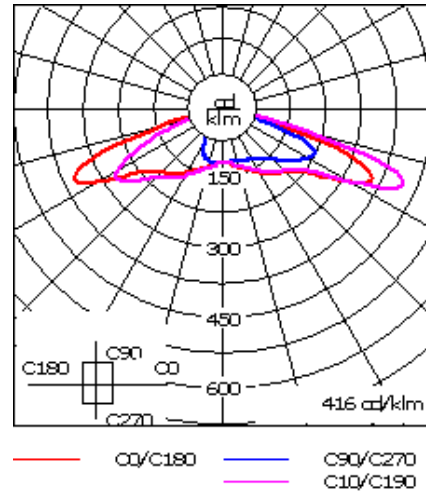
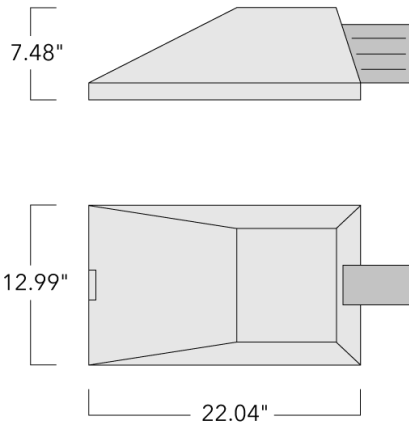

Specifications

Material description

Body	Marine-grade, die-cast aluminium alloy
Lens	Safety glass lens, hinged
Colors	<ul style="list-style-type: none"> RAL9004 Black RAL9007 Grey Metallic RAL9016 White RAL8019 Dark Bronze
Gasket	Silicone CCG® Controlled Compression Gasket
Fasteners	PCS Polymer Coated Stainless Steel Hardware
Ingress protection	IP66
Impact resistance	IK08
Corrosion resistance	5CE superior corrosion protection system
Windage	0.81 ft ²

WE-EF LIGHTING USA, LLC

410-D Keystone Drive, 15086 Warrendale, PA 15086 - Phone: +1 724 742 0030

customersupport.usa@we-ef.com - <https://we-ef.com/us>

Subject to technical changes and errors. - Generated on 11/23/2024

108-1639

PFL240 LED

we-ef

Electrical description

Power supply	Integral [ECG] electronic driver 120V-277V. 0-10V dimmable, to be specified with order.
Driver / Ballast	Integral EC electronic converter
Power factor	> 0.9
Surge protection	Integral 10kV Surge Protector

Additional information

Lifetime	Ta=25°/40° L90B10 > 90000h
BUG Rating	Please see individual Spec Sheets for classification of Backlight, Uplight and Glare.
Listings	ETL, UL-1598, CSA-C22.2#250.0. Suitable for Wet Locations.

WE-EF LIGHTING USA, LLC

410-D Keystone Drive, 15086 Warrendale, PA 15086 - Phone: +1 724 742 0030
customersupport.usa@we-ef.com - <https://we-ef.com/us>
Subject to technical changes and errors. - Generated on 11/23/2024

Mounting Accessories

Wall and pole brackets KI

Description	Part ID	A	C1	D1	D2	D x L1	H1	M1	Weight (lb)	Alpha	C	D	H
KI1-240 Pole bracket, single	108-0491	±30°	8.27			3 x 4	20.67		15.21	+15° / -30°	210		525

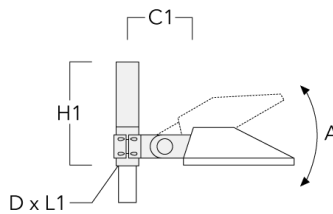

KI2-240 Pole bracket, double	108-0492	±30°	8.27"			3 x 4	20.67"		15.21 lbs	+15° / -30°	210		525
------------------------------	----------	------	-------	--	--	-------	--------	--	-----------	-------------	-----	--	-----

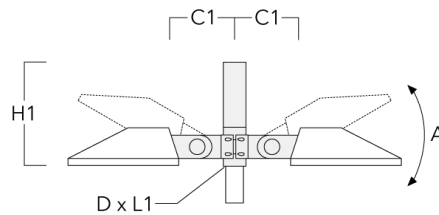

WE-EF LIGHTING USA, LLC

410-D Keystone Drive, 15086 Warrendale, PA 15086 - Phone: +1 724 742 0030

customersupport.usa@we-ef.com - <https://we-ef.com/us>

Subject to technical changes and errors. - Generated on 11/23/2024

PFL240 LED

Description	Part ID	A	C1	D1	D2	D × L1	H1	M1	Weight (lb)	Alpha	C	D	H
K10-240 Wall bracket	108-0493	30°	8.27	7.09	5.51				0.47	+15° / -30°	210	180	180

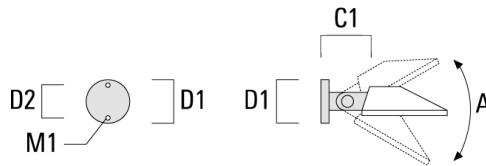

Pole brackets KL

Description	Part ID	C1	D × L1	H1	L	Weight (lb)	C	H
KL0-240 Wall bracket	108-2138	28.94"		31.02"		20 lbs	725	750

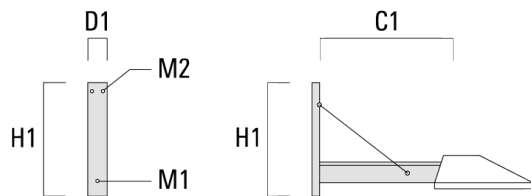

WE-EF LIGHTING USA, LLC

410-D Keystone Drive, 15086 Warrendale, PA 15086 - Phone: +1 724 742 0030

customersupport.usa@we-ef.com - <https://we-ef.com/us>

Subject to technical changes and errors. - Generated on 11/23/2024

PFL240 LED

Description	Part ID	C1	D x L1	H1	L	Weight (lb)	C	H
KL1-240 Pole bracket, single	108-0342	28.94	3 x 5	29.53	2.99	19.84	725	750

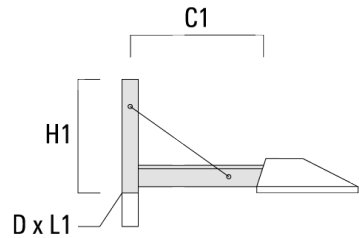

Wall and pole brackets KP

Description	Part ID	C1	D1	D2	D x L1	H1	L	M1	Weight (lb)	C	D	H
KP0-240 Wall bracket	108-0103	7.87	9.06	7.68				0.47	4.41	175	230	230

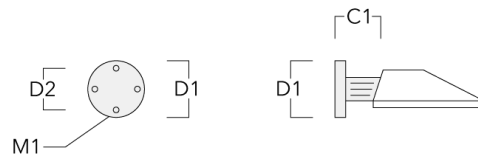

WE-EF LIGHTING USA, LLC

410-D Keystone Drive, 15086 Warrendale, PA 15086 - Phone: +1 724 742 0030

customersupport.usa@we-ef.com - <https://we-ef.com/us>

Subject to technical changes and errors. - Generated on 11/23/2024

PFL240 LED

Description	Part ID	C1	D1	D2	D x L1	H1	L	M1	Weight (lb)	C	D	H
KP1-240 Pole bracket, single	108-0104	8.46			3 x 3	22.64	2.99		8.38	175		575

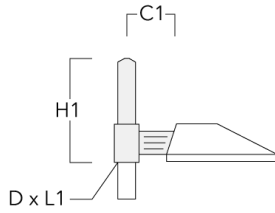

KP2-240 Pole bracket, double	108-0105	8.46			3 x 3	22.64	2.99		8.38	175		575
------------------------------	----------	------	--	--	-------	-------	------	--	------	-----	--	-----

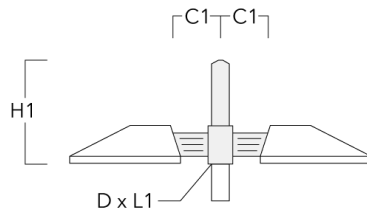

WE-EF LIGHTING USA, LLC

410-D Keystone Drive, 15086 Warrendale, PA 15086 - Phone: +1 724 742 0030
 customersupport.usa@we-ef.com - <https://we-ef.com/us>

Subject to technical changes and errors. - Generated on 11/23/2024

Pole brackets KP_L

Description	Part ID	C1	D x L1	H1	L	Weight (lb)	C	H
KP1-L-240 Pole bracket, single	108-0268	25.00	3 x 5	22.64	2.99	20.06	175	575

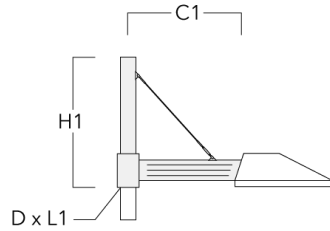

KP2-L-240 Pole bracket, double	108-0373	25.00	3 x 5	22.64	2.99	33.07	175	575
--------------------------------	----------	-------	-------	-------	------	-------	-----	-----

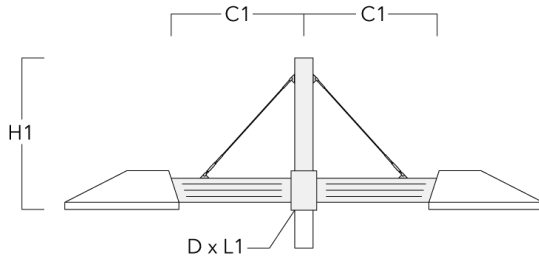

WE-EF LIGHTING USA, LLC

410-D Keystone Drive, 15086 Warrendale, PA 15086 - Phone: +1 724 742 0030
 customersupport.usa@we-ef.com - <https://we-ef.com/us>

Subject to technical changes and errors. - Generated on 11/23/2024

Pole brackets KX

Description	Part ID	C1	D × L1	H1	L	Weight (lb)	C	H
KX0-240 Wall bracket	108-0317	28.94"		13.78"		16 lbs	725	410

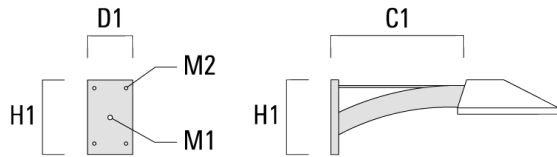

KX1-240 Pole bracket, single	108-0343	28.94	3 x 5	16.14	2.99	15.43	725	410
------------------------------	----------	-------	-------	-------	------	-------	-----	-----

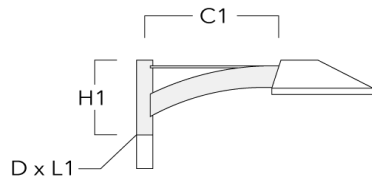

WE-EF LIGHTING USA, LLC

410-D Keystone Drive, 15086 Warrendale, PA 15086 - Phone: +1 724 742 0030

customersupport.usa@we-ef.com - <https://we-ef.com/us>

Subject to technical changes and errors. - Generated on 11/23/2024

PFL240 LED

Description	Part ID	C1	D x L1	H1	L	Weight (lb)	C	H
KX2-240 Pole bracket, double	108-0534	28.94	3 x 5	16.14	2.99	24.25	725	410

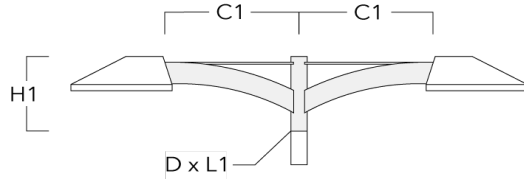

Pole brackets KY

Description	Part ID	A	C1	D x L1	H1	L	Weight (lb)	Alpha	C	H
KY1-240 Pole bracket, single	108-0500	±30°	8.27	3 x 3	36.61	2.99	21.83	+15° / -30°	210	575

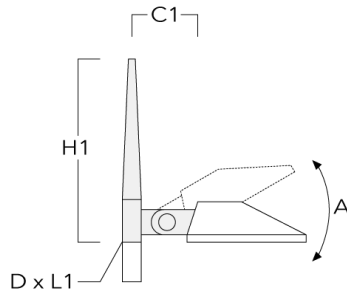

WE-EF LIGHTING USA, LLC

410-D Keystone Drive, 15086 Warrendale, PA 15086 - Phone: +1 724 742 0030

customersupport.usa@we-ef.com - <https://we-ef.com/us>

Subject to technical changes and errors. - Generated on 11/23/2024

PFL240 LED

Description	Part ID	A	C1	D x L1	H1	L	Weight (lb)	Alpha	C	H
KY2-240 Pole bracket, double	108-0501	±30°	8.27	3 x 3	28.74	2.99	28.22	+15° / -30°	210	575

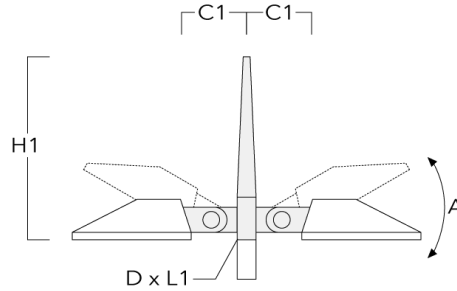

Pole clamp SI

Description	Part ID	C1	D1	Weight (lb)	C
SI1-240 Pole clamp, single (Ø 4"-4.5")	108-0781	8.27	4.0-4.5	8.82	210

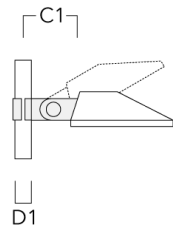

WE-EF LIGHTING USA, LLC

410-D Keystone Drive, 15086 Warrendale, PA 15086 - Phone: +1 724 742 0030

customersupport.usa@we-ef.com - <https://we-ef.com/us>

Subject to technical changes and errors. - Generated on 11/23/2024

108-1639

we-ef

PFL240 LED

Description	Part ID	C1	D1	Weight (lb)	C
SI1-240 Pole clamp, single (Ø 3"-3.5")	108-0482	8.27"	3.0"-3.5"	7.94 lbs	210

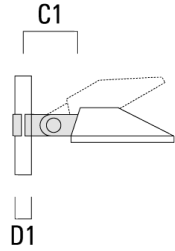

SI1-240 Pole clamp, single (Ø 4.5"-5.25")	108-0483	8.27	4.50-5.25	9.70 lbs	210
---	----------	------	-----------	----------	-----

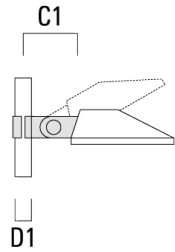

WE-EF LIGHTING USA, LLC

410-D Keystone Drive, 15086 Warrendale, PA 15086 - Phone: +1 724 742 0030

customersupport.usa@we-ef.com - <https://we-ef.com/us>

Subject to technical changes and errors. - Generated on 11/23/2024

108-1639

we-ef

PFL240 LED

Description	Part ID	C1	D1	Weight (lb)	C
SI2-240 Pole clamp, double (Ø 4"-4.5")	108-0783	8.27	4.0-4.5	12.57	210

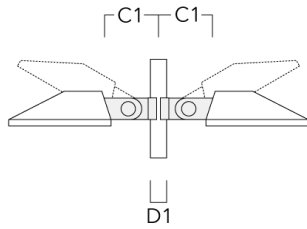

SI2-240 Pole clamp, double (Ø 3"-3.5")	108-0484	8.27"	3.0"-3.5"	15.88 lbs	210
--	----------	-------	-----------	-----------	-----

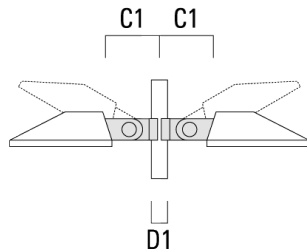

WE-EF LIGHTING USA, LLC

410-D Keystone Drive, 15086 Warrendale, PA 15086 - Phone: +1 724 742 0030
customersupport.usa@we-ef.com - <https://we-ef.com/us>

Subject to technical changes and errors. - Generated on 11/23/2024

108-1639

we-ef

PFL240 LED

Description	Part ID	C1	D1	Weight (lb)	C
SI2-240 Pole clamp, double (Ø 4.5"-5.25")	108-0485	8.27	4.50-5.25	13.70 lbs	210

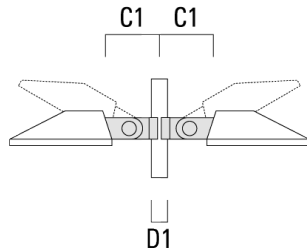

Pole clamp SK

Description	Part ID	C1	D1	Weight (lb)	C
SK1-240 Pole clamp, single (Ø 4"-4.5")	108-0782	6.89	4.0-4.50	7.50	175

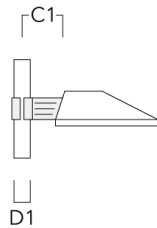

WE-EF LIGHTING USA, LLC

410-D Keystone Drive, 15086 Warrendale, PA 15086 - Phone: +1 724 742 0030
customersupport.usa@we-ef.com - <https://we-ef.com/us>

Subject to technical changes and errors. - Generated on 11/23/2024

108-1639

we-ef

PFL240 LED

Description	Part ID	C1	D1	Weight (lb)	C
SK1-240 Pole clamp, single (Ø 3"-3.5")	108-0788	6.89	3.0-3.50	6.61	175

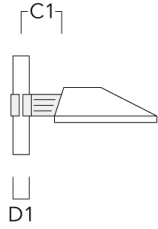

SK1-240 Pole clamp, single (Ø 4.5"-5.25")	108-0789	6.89	4.50-5.25	8.38	175
---	----------	------	-----------	------	-----

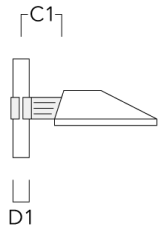

WE-EF LIGHTING USA, LLC

410-D Keystone Drive, 15086 Warrendale, PA 15086 - Phone: +1 724 742 0030
customersupport.usa@we-ef.com - <https://we-ef.com/us>

Subject to technical changes and errors. - Generated on 11/23/2024

108-1639

we-ef

PFL240 LED

Description	Part ID	C1	D1	Weight (lb)	C
SK2-240 Pole clamp, double (Ø 4"-4.5")	108-0784	6.89	4.0-4.50	9.48	175

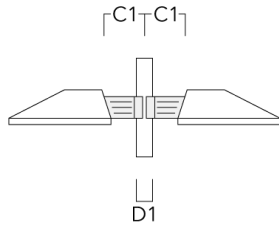

SK2-240 Pole clamp, double (Ø 3"-3.5")	108-0790	6.89	3.0-3.50	8.60	175
--	----------	------	----------	------	-----

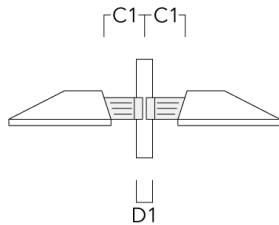

WE-EF LIGHTING USA, LLC

410-D Keystone Drive, 15086 Warrendale, PA 15086 - Phone: +1 724 742 0030
customersupport.usa@we-ef.com - <https://we-ef.com/us>

Subject to technical changes and errors. - Generated on 11/23/2024

108-1639

PFL240 LED

we-ef

Description	Part ID	C1	D1	Weight (lb)	C
SK2-240 Pole clamp, double (Ø 4.5"-5.25")	108-0791	6.89	4.50-5.25	10.36	175

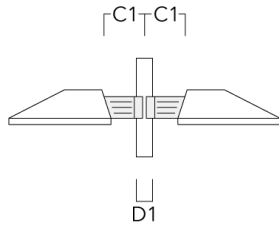

WE-EF LIGHTING USA, LLC

410-D Keystone Drive, 15086 Warrendale, PA 15086 - Phone: +1 724 742 0030
customersupport.usa@we-ef.com - <https://we-ef.com/us>

Subject to technical changes and errors. - Generated on 11/23/2024

108-1639

PFL240 LED

we-ef

Optical Accessories

Light shield

Description	Part ID	Additional information
LS180-[A60]	430-0038	Light shield LS180 to greatly reduce or eliminate light pollution. PA injection moulded component, black matt. Suitable for asymmetric light distribution [A60].
LS180	430-0029	Glare Shield for backlight spill. Glare Shield factory-installed or available as retrofit kit. Suitable for [S60], [S65], [S70], [R65], [P65] lenses. Must be specified at time of ordering.

WE-EF LIGHTING USA, LLC

410-D Keystone Drive, 15086 Warrendale, PA 15086 - Phone: +1 724 742 0030

customersupport.usa@we-ef.com - <https://we-ef.com/us>

Subject to technical changes and errors. - Generated on 11/23/2024