

108-1691

PFL240 LED

we-ef



Description

IP66, Class I. IK08. Marine-grade die-cast aluminium alloy. 5CE superior corrosion protection + primer including PCS hardware. Silicone rubber gaskets. Safety glass lens, hinged. PMMA OLC® LED optics for superior illumination and glare control. Optional 2200 K version up to max. 1050mA available. To be specified at time of ordering. DALI.

A professional lighting design in consultation with the relevant sections of AS/NZS-1158.4:2015 is essential for all applications with the [P45] lens.

Please note that the luminaire requires a mounting bracket for installation. This bracket needs to be ordered separately. Please choose from one of our various options listed under Mounting Accessories

Weight	13.50 kg
Light distribution	asymmetric, forward throw [A60]
Light source	LED-18/54W / 1050 mA - 3000 K
CRI	80
Power supply	EC
LEDs	18
Rated input power	59 W

Nominal Lumen (lm)

LED Lumen	430
Total Lumen	7740
Tj	85

Rated lumens (lm)

LED Lumen	321.2
Total Lumen	5782
Ta	25

WE-EF LIGHTING Pty Ltd

6/13 Downard Street, 3195 Braeside, Victoria - Phone: +61 3 8587 0444 - Fax: +61 3 8587 0499

info.australia@we-ef.com - <https://we-ef.com/aus>

Subject to technical changes and errors. - Generated on 23/11/2024

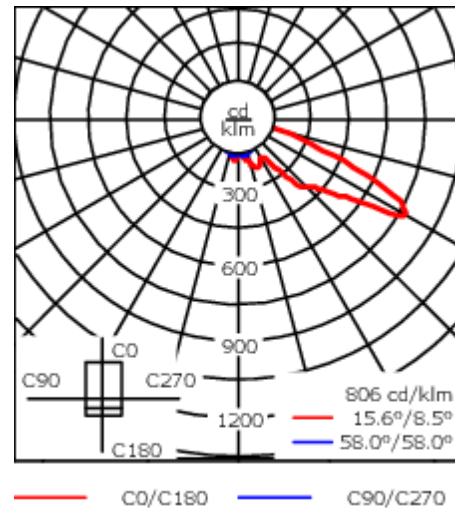
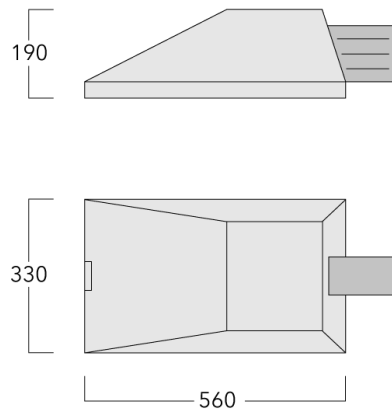

Specifications

Material description

Body	Marine-grade, die-cast aluminium alloy
Lens	Safety glass lens, hinged
Colours	<div style="display: flex; align-items: center;"> <div style="width: 20px; height: 15px; background-color: black; margin-right: 5px;"></div> RAL9004 Signal black </div> <div style="display: flex; align-items: center; margin-top: 5px;"> <div style="width: 20px; height: 15px; background-color: #cccccc; margin-right: 5px;"></div> RAL9006 White aluminium </div> <div style="display: flex; align-items: center; margin-top: 5px;"> <div style="width: 20px; height: 15px; background-color: #808080; margin-right: 5px;"></div> RAL9007 Grey aluminium </div>
Gasket	Silicone CCG® Controlled Compression Gasket
Fasteners	PCS Polymer Coated Stainless Steel Hardware (unpainted)
Ingress protection	IP66
Impact resistance	IK08
Corrosion resistance	5CE+Primer
Windage	0.075 m ²

Electrical description

Power supply	230V / 50 Hz
Driver / Ballast	Integral EC electronic converter. DALI
Power factor	> 0.9
Surge protection	In-pole surge protection SP10 device supplied. Please refer to WE-EF installation instructions for details. Use suffix +A for Integral surge protection.

108-1691

PFL240 LED

we-ef

Additional information

Lifetime Ta=40° L90B10 > 90000h

Warranty The product is supplied with 10-year warranty. Please refer to the LED Warranty Statement located on www.we-ef.com for further details.

WE-EF LIGHTING Pty Ltd

6/13 Downard Street, 3195 Braeside, Victoria - Phone: +61 3 8587 0444 - Fax: +61 3 8587 0499

info.australia@we-ef.com - <https://we-ef.com/aus>

Subject to technical changes and errors. - Generated on 23/11/2024

108-1691

PFL240 LED

we-ef

Control

Eco Step Dim® Basic

Description	Part ID
Eco Step Dim® Basic LED	430-0001

Eco Step Dim® Advanced

Description	Part ID
Eco Step Dim® Advanced LED	430-0002

WE-EF LIGHTING Pty Ltd

6/13 Downard Street, 3195 Braeside, Victoria - Phone: +61 3 8587 0444 - Fax: +61 3 8587 0499

info.australia@we-ef.com - <https://we-ef.com/aus>

Subject to technical changes and errors. - Generated on 23/11/2024

Mounting Accessories

Wall and pole brackets KI

Description	Part ID	A	C1	D1	D2	H1	M1	Weight (kg)	Alpha	C	D	H
KI0-240/260 Wall bracket	108-0493	±30°	210	180	140		12	5.70	±3°	210	180	180

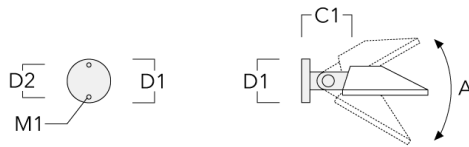

KI1-240 Pole bracket, single	108-0491	±30°	210			525		6.90	+15° / -30°	210		525
------------------------------	----------	------	-----	--	--	-----	--	------	-------------	-----	--	-----

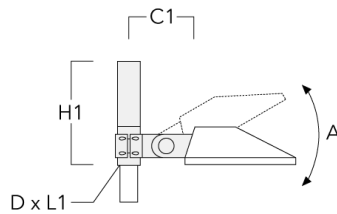

Description	Part ID	A	C1	D1	D2	H1	M1	Weight (kg)	Alpha	C	D	H
KI2-240 Pole bracket, double	108-0492	±30°	210			525		8.60	+15° / -30°	210		525



Pole brackets KL

Description	Part ID	C1	D x L1	H1	Weight (kg)	C	H
KL1-240 Pole bracket, single	108-0342	735	76 x 130	750	9	725	750

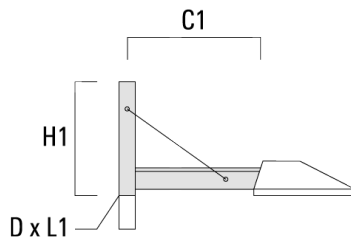

Description	Part ID	C1	D × L1	H1	Weight (kg)	C	H
KL2-240 Pole bracket, double	108-0532	735	76 x 130	750	14	725	750



Wall and pole brackets KP

Description	Part ID	C1	D1	D2	D × L1	H1	M1	Weight (kg)	C	D	H
KP0-240 Wall bracket	108-0103	200	230	195			12	2	175	230	230

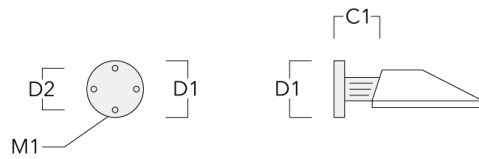

Description	Part ID	C1	D1	D2	D x L1	H1	M1	Weight (kg)	C	D	H
KP1-240 Pole bracket, single	108-0104	215			76 x 80	575		3.80	175		575

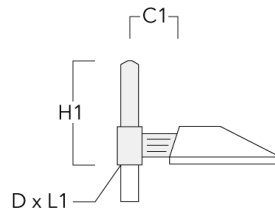

KP2-240 Pole bracket, double	108-0105	215			76 x 80	575		3.80	175		575
------------------------------	----------	-----	--	--	---------	-----	--	------	-----	--	-----

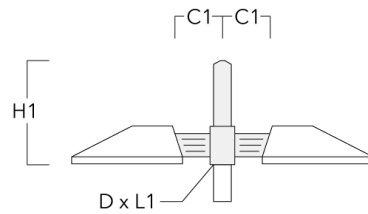

Pole brackets KP_L

Description	Part ID	C1	D x L1	H1	Weight (kg)	C	H
KP1-L-240 Pole bracket, single	108-0268	635	76 x 130	575	9.10	175	575



KP2-L-240 Pole bracket, double	108-0373	635	76 x 130	575	15	175	575
--------------------------------	----------	-----	----------	-----	----	-----	-----



Pole brackets KX

Description	Part ID	C1	D x L1	H1	Weight (kg)	C	H
KX1-240 Pole bracket, single	108-0343	735	76 x 130	410	7	725	410

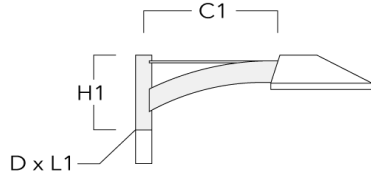

KX2-240 Pole bracket, double	108-0534	735	76 x 130	410	11	725	410
------------------------------	----------	-----	----------	-----	----	-----	-----

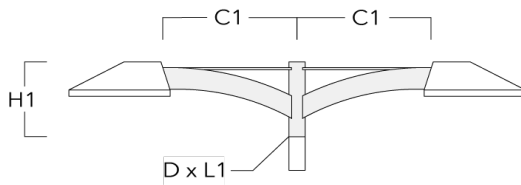

Pole brackets KY

Description	Part ID	A	C1	D x L1	H1	Weight (kg)	Alpha	C	H
KY1-240 Pole bracket, single	108-0500	±30°	210	76 x 80	930	9.90	+15° / -30°	210	575

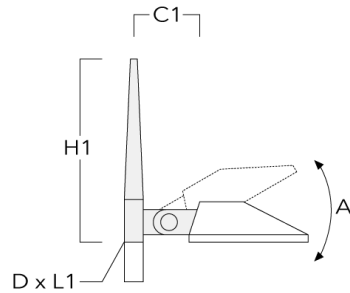

KY2-240 Pole bracket, double	108-0501	±30°	210	76 x 80	730	12.80	+15° / -30°	210	575
------------------------------	----------	------	-----	---------	-----	-------	-------------	-----	-----

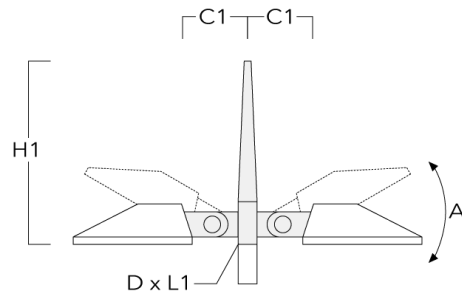

108-1691

PFL240 LED

we-ef

Pole clamp SI

Description	Part ID	C1	D1	Weight (kg)	C
SI1-240/260 Pole clamp, single (Ø 76-89)	108-0482	210	76-89	3.60	210



SI1-240/260 Pole clamp, single (Ø 114-133)	108-0483	210	114-133	4.40	210
--	----------	-----	---------	------	-----



WE-EF LIGHTING Pty Ltd

6/13 Downard Street, 3195 Braeside, Victoria - Phone: +61 3 8587 0444 - Fax: +61 3 8587 0499

info.australia@we-ef.com - <https://we-ef.com/aus>

Subject to technical changes and errors. - Generated on 23/11/2024

108-1691

PFL240 LED

we-ef

Description	Part ID	C1	D1	Weight (kg)	C
SI1-240/260 Pole clamp, single (Ø 102-114)	108-0781	210	102-114	4	210



SI2-240/260 Pole clamp, double (Ø 76-89)	108-0484	210	76-89	5.20	210
--	----------	-----	-------	------	-----



WE-EF LIGHTING Pty Ltd

6/13 Downard Street, 3195 Braeside, Victoria - Phone: +61 3 8587 0444 - Fax: +61 3 8587 0499

info.australia@we-ef.com - <https://we-ef.com/aus>

Subject to technical changes and errors. - Generated on 23/11/2024

108-1691

PFL240 LED

we-ef

Description	Part ID	C1	D1	Weight (kg)	C
SI2-240/260 Pole clamp, double (Ø 114-133)	108-0485	210	114-133	6.20	210



SI2-240/260 Pole clamp, double (Ø 102-114)	108-0783	210	102-114	5.70	210
--	----------	-----	---------	------	-----



WE-EF LIGHTING Pty Ltd

6/13 Downard Street, 3195 Braeside, Victoria - Phone: +61 3 8587 0444 - Fax: +61 3 8587 0499

info.australia@we-ef.com - <https://we-ef.com/aus>

Subject to technical changes and errors. - Generated on 23/11/2024

108-1691

PFL240 LED

we-ef

Pole clamp SK

Description	Part ID	C1	D1	Weight (kg)	C
SK1-240 Pole clamp, single (Ø 102-114)	108-0782	175	102-114	3.40	175

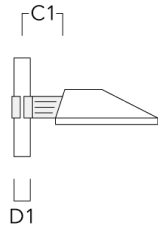

SK1-240 Pole clamp, single (Ø 76-89)	108-0788	175	76-89	3	175
--------------------------------------	----------	-----	-------	---	-----



108-1691

PFL240 LED

we-ef

Description	Part ID	C1	D1	Weight (kg)	C
SK1-240 Pole clamp, single (Ø 114-133)	108-0789	175	114-133	3.80	175



SK2-240 Pole clamp, double (Ø 102-114)	108-0784	175	102-114	4.30	175
--	----------	-----	---------	------	-----



WE-EF LIGHTING Pty Ltd

6/13 Downard Street, 3195 Braeside, Victoria - Phone: +61 3 8587 0444 - Fax: +61 3 8587 0499

info.australia@we-ef.com - <https://we-ef.com/aus>

Subject to technical changes and errors. - Generated on 23/11/2024

108-1691

PFL240 LED

we-ef

Description	Part ID	C1	D1	Weight (kg)	C
SK2-240 Pole clamp, double (Ø 76-89)	108-0790	175	76-89	3.90	175



SK2-240 Pole clamp, double (Ø 114-133)	108-0791	175	114-133	4.70	175
--	----------	-----	---------	------	-----



WE-EF LIGHTING Pty Ltd

6/13 Downard Street, 3195 Braeside, Victoria - Phone: +61 3 8587 0444 - Fax: +61 3 8587 0499

info.australia@we-ef.com - <https://we-ef.com/aus>

Subject to technical changes and errors. - Generated on 23/11/2024

Optical Accessories**Light shield**

Description	Part ID	Additional information
LS180-[A60]	003-4018	Glare Shield for backlight spill. Glare Shield factory-installed or available as retrofit kit. Suitable for [A60] lenses. Must be specified at time of ordering.
LS180	003-4019	Glare Shield for backlight spill. Glare Shield factory-installed or available as retrofit kit. Suitable for [S60], [S65], [S70], [R65], [P65] lenses. Must be specified at time of ordering.