

108-1774

PFL230 LED

**we-ef**



**Description**

IP66 in both an upward or downward orientation. Class I. IK08. Marine-grade, die-cast aluminum alloy. 5CE superior corrosion protection including PCS hardware. Silicone CCG® Controlled Compression Gasket. Safety glass lens, hinged frame. Luminaire is factory-wired and supplied with 30' of black, three conductor, flexible SEOW cord for power connection at pole-base hand hole. PMMA optics for superior illumination and glare control. OLC® One LED Concept. 0-10V Dimming comes standard with luminaire.

Recommended mounting height 10-20 ft, depending on wattage selected; mounting bracket required.

Specify product with 7 Digit product code - Finish Color. Accessories, such as mounting, optical, and electrical, must be specified separately.

Example: XXX-XXXX-9004 (Black)  
+ XXX-XXXX (Accessory 1)

|                    |                              |
|--------------------|------------------------------|
| Weight             | 22.00 lb                     |
| Light distribution | [S65] Type III Medium        |
| Light source       | LED-12/12W / 350 mA - 4000 K |
| CRI                | 80                           |
| Power supply       | electronic gear              |
| BUG                | B1 U0 G0                     |
| LEDs               | 12                           |
| Rated input power  | 13.9 W                       |

**Nominal Lumen (lm)**

|             |      |
|-------------|------|
| LED Lumen   | 170  |
| Total Lumen | 2040 |
| Tj          | 85   |

**Rated lumens (lm)**

|             |        |
|-------------|--------|
| LED Lumen   | 139.9  |
| Total Lumen | 1678.7 |
| Ta          | 25     |

**WE-EF LIGHTING USA, LLC**

410-D Keystone Drive, 15086 Warrendale, PA 15086 - Phone: +1 724 742 0030  
customersupport.usa@we-ef.com - <https://we-ef.com/us>  
Subject to technical changes and errors. - Generated on 11/23/2024

108-1774

PFL230 LED

**we-ef**

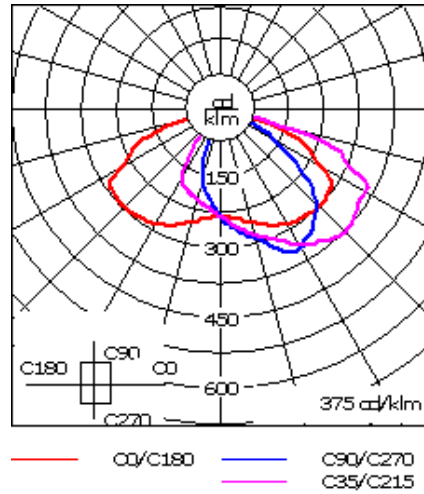
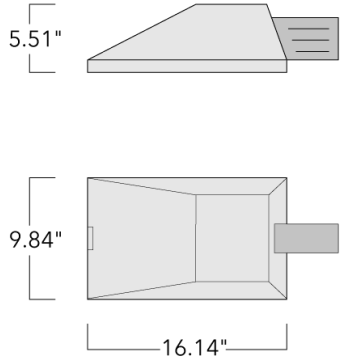

## Specifications

### Material description

|                      |   |
|----------------------|---|
| Body                 | Marine-grade, die-cast aluminium alloy  |
| Lens                 | Safety glass lens, hinged   |
| Colors               | <div style="display: flex; flex-direction: column; gap: 5px;"> <div style="display: flex; align-items: center;"><span style="width: 20px; height: 10px; background-color: black; margin-right: 5px;"></span> RAL9004 Black</div> <div style="display: flex; align-items: center;"><span style="width: 20px; height: 10px; background-color: grey; margin-right: 5px;"></span> RAL9007 Grey Metallic</div> <div style="display: flex; align-items: center;"><span style="width: 20px; height: 10px; background-color: white; margin-right: 5px;"></span> RAL9016 White</div> <div style="display: flex; align-items: center;"><span style="width: 20px; height: 10px; background-color: darkgrey; margin-right: 5px;"></span> RAL8019 Dark Bronze</div> </div> |
| Gasket               | Silicone CCG® Controlled Compression Gasket   |
| Fasteners            | PCS Polymer Coated Stainless Steel Hardware   |
| Ingress protection   | IP66  |
| Impact resistance    | IK08  |
| Corrosion resistance | 5CE superior corrosion protection system  |
| Windage              | 0.45 ft <sup>2</sup>  |

### WE-EF LIGHTING USA, LLC

410-D Keystone Drive, 15086 Warrendale, PA 15086 - Phone: +1 724 742 0030

customersupport.usa@we-ef.com - <https://we-ef.com/us>

Subject to technical changes and errors. - Generated on 11/23/2024

**108-1774**

**PFL230 LED**

**we-ef**

**Electrical description**

---

|                  |   |
|------------------|---|
| Power supply     | Integral [ECG] electronic driver 120V-277V. 0-10V dimmable, to be specified with order. |
| Driver / Ballast | Integral EC electronic converter  |
| Power factor     | > 0.9   |
| Surge protection | Integral 10kV Surge Protector   |

---

**Additional information**

---

|            |   |
|------------|---|
| Lifetime   | Ta=25°/40° L90B10 > 90000h  |
| BUG Rating | Please see individual Spec Sheets for classification of Backlight, Uplight and Glare. |
| Listings   | ETL, UL-1598, CSA-C22.2#250.0. Suitable for Wet Locations.                            |

---

**WE-EF LIGHTING USA, LLC**

410-D Keystone Drive, 15086 Warrendale, PA 15086 - Phone: +1 724 742 0030

customersupport.usa@we-ef.com - <https://we-ef.com/us>

Subject to technical changes and errors. - Generated on 11/23/2024

**Mounting Accessories**

**Wall and pole brackets KI**

| Description          | Part ID  | A    | C1   | D1   | D2   | D × L1 | H1 | L | M1   | Weight (lb) | Alpha | C   | D   | H   |
|----------------------|----------|------|------|------|------|--------|----|---|------|-------------|-------|-----|-----|-----|
| KI0-230 Wall bracket | 108-0430 | ±30° | 8.27 | 7.09 | 5.83 |        |    |   | 0.26 | 6.61        | ± 3°  | 210 | 180 | 180 |

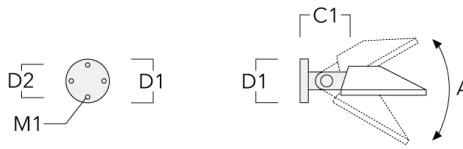

|                              |          |      |      |  |  |       |       |      |  |      |      |     |  |     |
|------------------------------|----------|------|------|--|--|-------|-------|------|--|------|------|-----|--|-----|
| KI1-230 Pole bracket, single | 108-0431 | ±30° | 8.27 |  |  | 3 x 3 | 18.70 | 2.99 |  | 9.48 | ± 3° | 210 |  | 475 |
|------------------------------|----------|------|------|--|--|-------|-------|------|--|------|------|-----|--|-----|

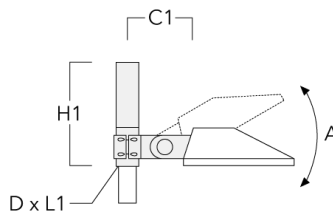

**PFL230 LED**

| Description                  | Part ID  | A    | C1   | D1 | D2 | D × L1 | H1    | L    | M1 | Weight (lb) | Alpha | C   | D | H   |
|------------------------------|----------|------|------|----|----|--------|-------|------|----|-------------|-------|-----|---|-----|
| K12-230 Pole bracket, double | 108-0432 | ±30° | 8.27 |    |    | 3 x 3  | 18.70 | 2.99 |    | 9.48        | ± 3°  | 210 |   | 475 |

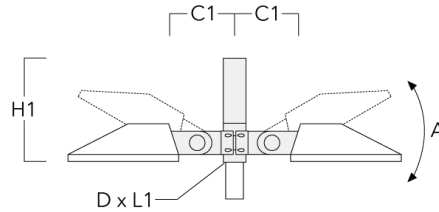

**Wall and pole brackets KP**

| Description          | Part ID  | C1   | D1   | D2   | D × L1 | H1 | L | M1   | Weight (lb) | C   | D   | H   |
|----------------------|----------|------|------|------|--------|----|---|------|-------------|-----|-----|-----|
| KP0-230 Wall bracket | 108-0433 | 7.68 | 7.09 | 5.51 |        |    |   | 0.47 | 3.31        | 175 | 180 | 180 |

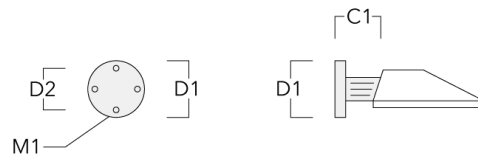

**WE-EF LIGHTING USA, LLC**

410-D Keystone Drive, 15086 Warrendale, PA 15086 - Phone: +1 724 742 0030

customersupport.usa@we-ef.com - <https://we-ef.com/us>

Subject to technical changes and errors. - Generated on 11/23/2024

**PFL230 LED**

| Description                  | Part ID  | C1   | D1 | D2 | D × L1 | H1    | L    | M1 | Weight (lb) | C   | D | H   |
|------------------------------|----------|------|----|----|--------|-------|------|----|-------------|-----|---|-----|
| KP1-230 Pole bracket, single | 108-0434 | 8.27 |    |    | 3 x 3  | 20.67 | 2.99 |    | 7.94        | 175 |   | 525 |

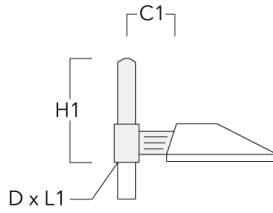

|                              |          |      |  |  |       |       |      |  |      |     |  |     |
|------------------------------|----------|------|--|--|-------|-------|------|--|------|-----|--|-----|
| KP2-230 Pole bracket, double | 108-0435 | 8.27 |  |  | 3 x 3 | 20.67 | 2.99 |  | 9.48 | 175 |  | 525 |
|------------------------------|----------|------|--|--|-------|-------|------|--|------|-----|--|-----|

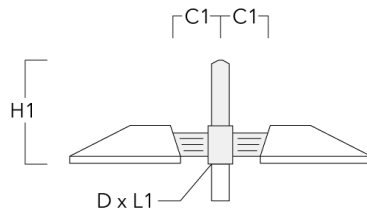

**WE-EF LIGHTING USA, LLC**

410-D Keystone Drive, 15086 Warrendale, PA 15086 - Phone: +1 724 742 0030  
 customersupport.usa@we-ef.com - <https://we-ef.com/us>

Subject to technical changes and errors. - Generated on 11/23/2024

**Pole brackets KP\_L**

| Description                    | Part ID  | C1    | D x L1 | H1    | L    | Weight (lb) | C   | H   |
|--------------------------------|----------|-------|--------|-------|------|-------------|-----|-----|
| KP1-L-230 Pole bracket, single | 108-0713 | 17.72 | 3 x 5  | 20.67 | 2.99 | 13.89       | 175 | 525 |

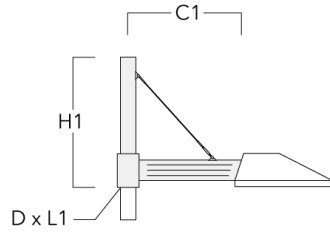

|                                |          |       |       |       |      |       |     |     |
|--------------------------------|----------|-------|-------|-------|------|-------|-----|-----|
| KP2-L-230 Pole bracket, double | 108-0714 | 17.72 | 3 x 5 | 20.67 | 2.99 | 20.94 | 175 | 525 |
|--------------------------------|----------|-------|-------|-------|------|-------|-----|-----|

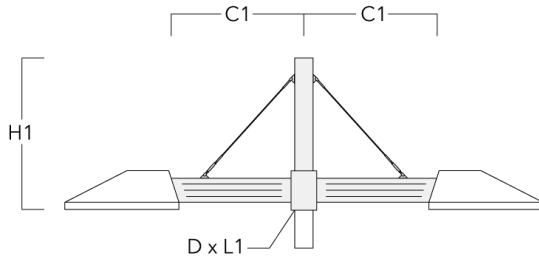

**WE-EF LIGHTING USA, LLC**

410-D Keystone Drive, 15086 Warrendale, PA 15086 - Phone: +1 724 742 0030  
 customersupport.usa@we-ef.com - <https://we-ef.com/us>

Subject to technical changes and errors. - Generated on 11/23/2024

**Pole brackets KY**

| Description                  | Part ID  | A    | C1   | D x L1 | H1    | L    | Weight(lb) | Alpha | C   | H   |
|------------------------------|----------|------|------|--------|-------|------|------------|-------|-----|-----|
| KY1-230 Pole bracket, single | 108-0496 | ±30° | 8.27 | 3 x 3  | 28.74 | 2.99 | 18.08      | ± 3°  | 210 | 525 |

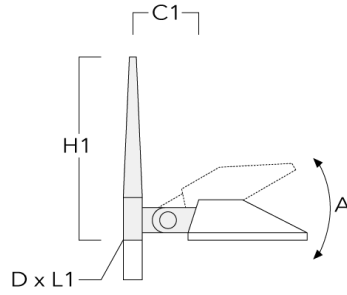

|                              |          |      |      |       |       |      |       |      |     |     |
|------------------------------|----------|------|------|-------|-------|------|-------|------|-----|-----|
| KY2-230 Pole bracket, double | 108-0497 | ±30° | 8.27 | 3 x 3 | 36.61 | 2.99 | 20.72 | ± 3° | 210 | 525 |
|------------------------------|----------|------|------|-------|-------|------|-------|------|-----|-----|

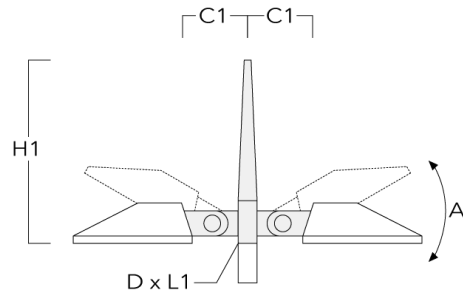

**WE-EF LIGHTING USA, LLC**

410-D Keystone Drive, 15086 Warrendale, PA 15086 - Phone: +1 724 742 0030  
 customersupport.usa@we-ef.com - <https://we-ef.com/us>

Subject to technical changes and errors. - Generated on 11/23/2024



108-1774

**we-ef**

PFL230 LED

**Pole clamp SI**

---

| Description                            | Part ID  | C1   | D1       | Weight (lb) | C   |
|--|----------|------|----------|-------------|-----|
| SI1-230 Pole clamp, single (Ø 3"-3.5") | 108-0478 | 8.27 | 3.0-3.50 | 6.39        | 210 |

---

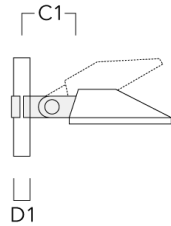

---

|  |          |      |          |      |     |
|--|----------|------|----------|------|-----|
| SI1-230 Pole clamp, single (Ø 4"-4.5") | 108-0479 | 8.27 | 4.0-4.50 | 6.83 | 210 |
|--|----------|------|----------|------|-----|

---

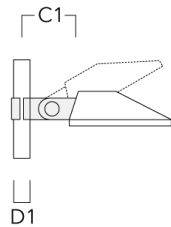

**WE-EF LIGHTING USA, LLC**

410-D Keystone Drive, 15086 Warrendale, PA 15086 - Phone: +1 724 742 0030

customersupport.usa@we-ef.com - <https://we-ef.com/us>

Subject to technical changes and errors. - Generated on 11/23/2024

**PFL230 LED**

---

| Description                            | Part ID  | C1   | D1       | Weight (lb) | C   |
|--|----------|------|----------|-------------|-----|
| SI2-230 Pole clamp, double (Ø 3"-3.5") | 108-0480 | 8.27 | 3.0-3.50 | 9.92        | 210 |

---

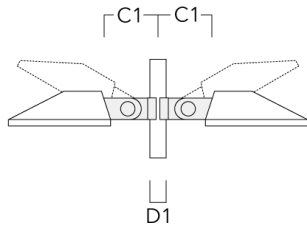

---

|  |          |      |          |       |     |
|--|----------|------|----------|-------|-----|
| SI2-230 Pole clamp, double (Ø 4"-4.5") | 108-0481 | 8.27 | 4.0-4.50 | 10.36 | 210 |
|--|----------|------|----------|-------|-----|

---

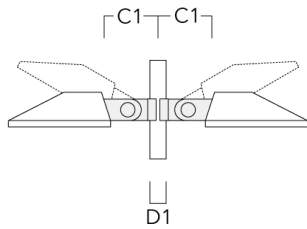

**WE-EF LIGHTING USA, LLC**

410-D Keystone Drive, 15086 Warrendale, PA 15086 - Phone: +1 724 742 0030  
customersupport.usa@we-ef.com - <https://we-ef.com/us>  
Subject to technical changes and errors. - Generated on 11/23/2024

108-1774

PFL230 LED

**we-ef**

**Pole clamp SK**

---

| Description                            | Part ID  | C1   | D1       | Weight (lb) | C   |
|--|----------|------|----------|-------------|-----|
| SK1-230 Pole clamp, single (Ø 3"-3.5") | 108-0474 | 6.89 | 3.0-3.50 | 4.63        | 175 |

---

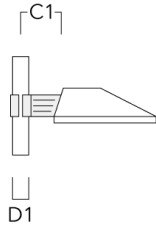

---

|  |          |      |          |      |     |
|--|----------|------|----------|------|-----|
| SK1-230 Pole clamp, single (Ø 4"-4.5") | 108-0475 | 6.89 | 4.0-4.50 | 5.29 | 175 |
|--|----------|------|----------|------|-----|

---

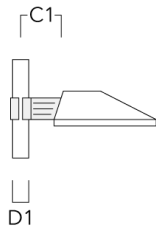

**WE-EF LIGHTING USA, LLC**

410-D Keystone Drive, 15086 Warrendale, PA 15086 - Phone: +1 724 742 0030  
customersupport.usa@we-ef.com - <https://we-ef.com/us>

Subject to technical changes and errors. - Generated on 11/23/2024

108-1774

PFL230 LED

**we-ef**

---

| Description                            | Part ID  | C1   | D1       | Weight (lb) | C   |
|--|----------|------|----------|-------------|-----|
| SK2-230 Pole clamp, double (Ø 3"-3.5") | 108-0476 | 6.89 | 3.0-3.50 | 6.39        | 175 |

---

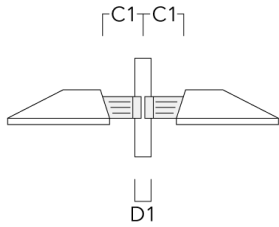

---

|  |          |      |          |      |     |
|--|----------|------|----------|------|-----|
| SK2-230 Pole clamp, double (Ø 4"-4.5") | 108-0477 | 6.89 | 4.0-4.50 | 7.05 | 175 |
|--|----------|------|----------|------|-----|

---

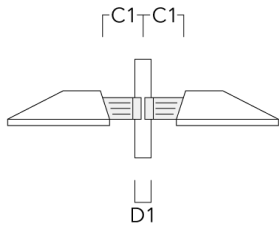

**WE-EF LIGHTING USA, LLC**

410-D Keystone Drive, 15086 Warrendale, PA 15086 - Phone: +1 724 742 0030  
customersupport.usa@we-ef.com - <https://we-ef.com/us>

Subject to technical changes and errors. - Generated on 11/23/2024

**108-1774**

**PFL230 LED**

**we-ef**

## **Optical Accessories**

### **Light shield**

| Description | Part ID  | Additional information  |
|-------------|----------|---|
| LS180-[A60] | 430-0038 | Light shield LS180 to greatly reduce or eliminate light pollution.<br>PA injection moulded component, black matt.<br>Suitable for asymmetric light distribution [A60].                          |
| LS180       | 430-0029 | Glare Shield for backlight spill. Glare Shield factory-installed or available as retrofit kit.<br>Suitable for [S60], [S65], [S70], [R65], [P65] lenses. Must be specified at time of ordering. |

**WE-EF LIGHTING USA, LLC**

410-D Keystone Drive, 15086 Warrendale, PA 15086 - Phone: +1 724 742 0030  
customersupport.usa@we-ef.com - <https://we-ef.com/us>

Subject to technical changes and errors. - Generated on 11/23/2024