



Description

IP66, Class I. Class II on request. IK08. Marine-grade die-cast aluminium alloy. 5CE superior corrosion protection including PCS hardware. Silicone CCG® Controlled Compression Gasket. Safety glass lens, hinged. PMMA OLC® optics for superior illumination and glare control.

Optional 2200 K version up to max. 1050mA available. To be specified at time of ordering.

Brackets to be ordered separately.

Weight	10.00 kg
Light distribution	asymmetric, side throw beam [S65]
Light source	LED-18/18W / 350 mA - 4000 K
CRI	80
Power supply	EC
LEDs	18
Rated input power	21 W
Nominal Lumen (lm)	
LED Lumen	170
Total Lumen	3060
Tj	85
Rated lumens (lm)	
LED Lumen	139.9
Total Lumen	2518.1
Ta	25

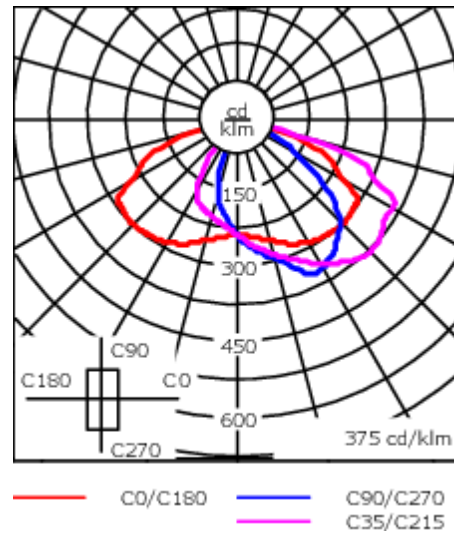
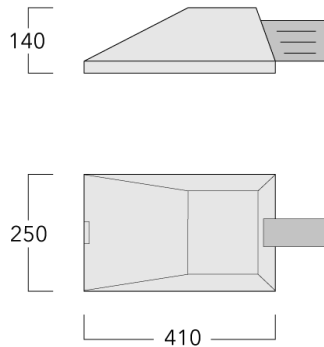

Specifications

Material description

Body	Marine-grade, die-cast aluminium alloy
Lens	Safety glass lens, hinged
Colours	<div style="display: flex; align-items: center; gap: 10px;"> <div style="width: 20px; height: 15px; background-color: black; margin-right: 5px;"></div> RAL9004 Signal black </div> <div style="display: flex; align-items: center; gap: 10px;"> <div style="width: 20px; height: 15px; background-color: #cccccc; margin-right: 5px;"></div> RAL9006 White aluminium </div> <div style="display: flex; align-items: center; gap: 10px;"> <div style="width: 20px; height: 15px; background-color: #808080; margin-right: 5px;"></div> RAL9007 Grey aluminium </div> <div style="display: flex; align-items: center; gap: 10px;"> <div style="width: 20px; height: 15px; background-color: #333333; margin-right: 5px;"></div> RAL7016 Anthracite grey </div> <div style="display: flex; align-items: center; gap: 10px;"> <div style="width: 20px; height: 15px; background-color: #e0e0e0; margin-right: 5px;"></div> RAL9016 Traffic white </div>
Gasket	Silicone CCG® Controlled Compression Gasket
Fasteners	PCS Polymer Coated Stainless Steel Hardware
Ingress protection	IP66
Impact resistance	IK08
Corrosion resistance	5CE
Windage	0.042 m ²

Electrical description

Power supply	220-240V / 50-60 Hz
Driver / Ballast	Integral EC electronic converter. DALI
Power factor	> 0.9
Surge protection	6/6 kV (optional SP10)

WE-EF LEUCHTEN GmbH

Töpinger Straße 16, 29646 Bispingen, Germany - Phone: +49 5194 909-0

info@we-ef.com - <https://we-ef.com>

Subject to technical changes and errors. - Generated on 23/10/2024

108-1782

PFL230 LED

we-ef

Additional information

Lifetime Ta=25° L90B10 > 90000h

Energy efficiency class C-D (Light source)

WE-EF LEUCHTEN GmbH

Töpinger Straße 16, 29646 Bispingen, Germany - Phone: +49 5194 909-0

info@we-ef.com - <https://we-ef.com>

Subject to technical changes and errors. - Generated on 23/10/2024

108-1782

PFL230 LED

we-ef

Control

Eco Step Dim® Basic

Description	Part ID
Eco Step Dim® Basic LED	430-0001

Eco Step Dim® Advanced

Description	Part ID
Eco Step Dim® Advanced LED	430-0002

WE-EF LEUCHTEN GmbH

Töpinger Straße 16, 29646 Bispingen, Germany - Phone: +49 5194 909-0

info@we-ef.com - <https://we-ef.com>

Subject to technical changes and errors. - Generated on 23/10/2024

Mounting Accessories

Wall and pole brackets KI

Description	Part ID	A	C1	D1	D2	D × L1	H1	M1	Weight (kg)	Alpha	C	D	H
KI0-230 Wall bracket	108-0430	±30°	210	180	148			6.5	3.00	± 3°	210	180	180

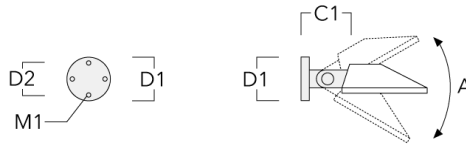

KI1-230 Pole bracket, single	108-0431	±30°	210			76 x 80	475		4.30	± 3°	210		475
------------------------------	----------	------	-----	--	--	---------	-----	--	------	------	-----	--	-----

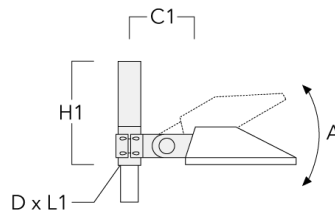

Description	Part ID	A	C1	D1	D2	D × L1	H1	M1	Weight (kg)	Alpha	C	D	H
KI2-230 Pole bracket, double	108-0432	±30°	210			76 x 80	475		6	± 3°	210		475

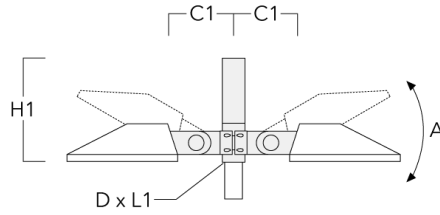

Wall and pole brackets KP

Description	Part ID	C1	D1	D2	D × L1	H1	M1	Weight (kg)	C	D	H
KP0-230 Wall bracket	108-0433	195	180	140			12	1.50	175	180	180

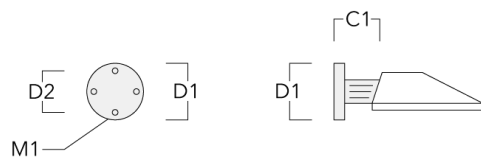

PFL230 LED

Description	Part ID	C1	D1	D2	D x L1	H1	M1	Weight (kg)	C	D	H
KP1-230 Pole bracket, single	108-0434	210			76 x 80	525		3.60	175		525

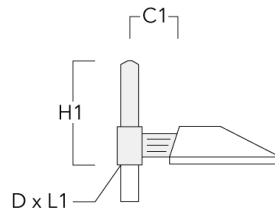

KP2-230 Pole bracket, double	108-0435	210			76 x 80	525		4.30	175		525
------------------------------	----------	-----	--	--	---------	-----	--	------	-----	--	-----

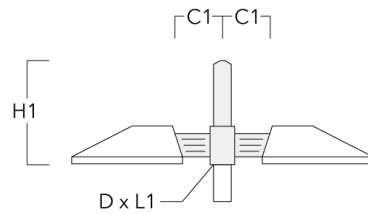

Pole brackets KP_L

WE-EF LEUCHTEN GmbH

Töpinger Straße 16, 29646 Bispingen, Germany - Phone: +49 5194 909-0

info@we-ef.com - <https://we-ef.com>

Subject to technical changes and errors. - Generated on 23/10/2024

PFL230 LED

Description	Part ID	C1	D x L1	H1	Weight (kg)	C	H
KP1-L-230 Pole bracket, single	108-0713	450	76 x 130	525	6.30	175	525

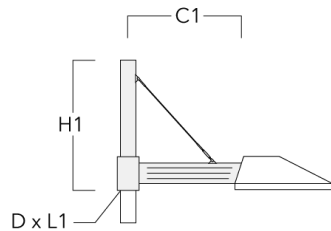

KP2-L-230 Pole bracket, double	108-0714	450	76 x 130	525	9.50	175	525
--------------------------------	----------	-----	----------	-----	------	-----	-----

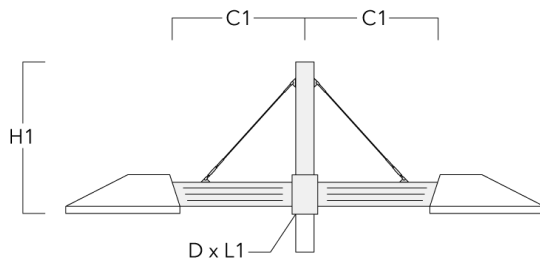

Pole brackets KY

WE-EF LEUCHTEN GmbH

Töpinger Straße 16, 29646 Bispingen, Germany - Phone: +49 5194 909-0

info@we-ef.com - <https://we-ef.com>

Subject to technical changes and errors. - Generated on 23/10/2024

PFL230 LED

Description	Part ID	A	C1	D x L1	H1	Weight (kg)	Alpha	C	H
KY1-230 Pole bracket, single	108-0496	±30°	210	76 x 80	730	8.20	± 3°	210	525

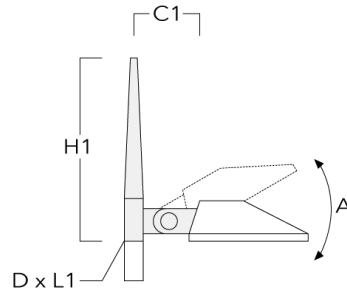

KY2-230 Pole bracket, double	108-0497	±30°	210	76 x 80	730	9.40	± 3°	210	525
------------------------------	----------	------	-----	---------	-----	------	------	-----	-----

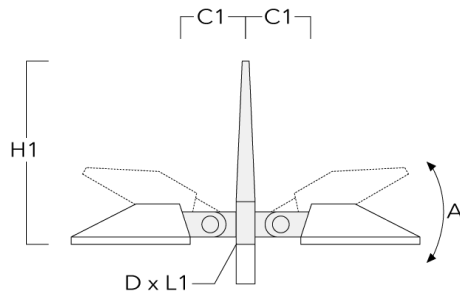

Pole clamp SI

WE-EF LEUCHTEN GmbH

Töpinger Straße 16, 29646 Bispingen, Germany - Phone: +49 5194 909-0

info@we-ef.com - <https://we-ef.com>

Subject to technical changes and errors. - Generated on 23/10/2024

108-1782

PFL230 LED

we-ef

Description	Part ID	C1	D1	Weight (kg)	C
SI1-230 Pole clamp, single (Ø 76-89)	108-0478	210	76-89	2.90	210

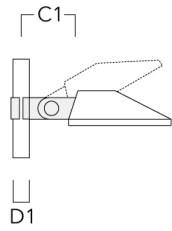

SI1-230 Pole clamp, single (Ø 102-114)	108-0479	210	102-114	3.10	210
--	----------	-----	---------	------	-----

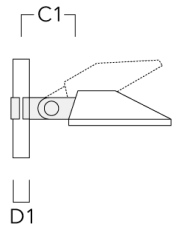

WE-EF LEUCHTEN GmbH

Töpinger Straße 16, 29646 Bispingen, Germany - Phone: +49 5194 909-0

info@we-ef.com - <https://we-ef.com>

Subject to technical changes and errors. - Generated on 23/10/2024

PFL230 LED

Description	Part ID	C1	D1	Weight (kg)	C
SI2-230 Pole clamp, double (Ø 76-89)	108-0480	210	76-89	4.50	210

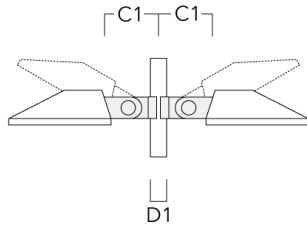

SI2-230 Pole clamp, double (Ø 102-114)	108-0481	210	102-114	4.70	210
--	----------	-----	---------	------	-----

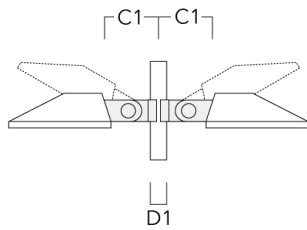

Pole clamp SK

WE-EF LEUCHTEN GmbH

Töpinger Straße 16, 29646 Bispingen, Germany - Phone: +49 5194 909-0

info@we-ef.com - <https://we-ef.com>

Subject to technical changes and errors. - Generated on 23/10/2024

108-1782

PFL230 LED

we-ef

Description	Part ID	C1	D1	Weight (kg)	C
SK1-230 Pole clamp, single (Ø 76-89)	108-0474	175	76-89	2.10	175

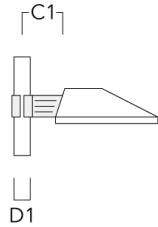

SK1-230 Pole clamp, single (Ø 102-114)	108-0475	175	102-114	2.40	175
--	----------	-----	---------	------	-----

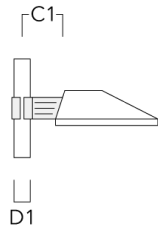

WE-EF LEUCHTEN GmbH

Töpinger Straße 16, 29646 Bispingen, Germany - Phone: +49 5194 909-0

info@we-ef.com - <https://we-ef.com>

Subject to technical changes and errors. - Generated on 23/10/2024

PFL230 LED

Description	Part ID	C1	D1	Weight (kg)	C
SK2-230 Pole clamp, double (Ø 76-89)	108-0476	175	76-89	2.90	175

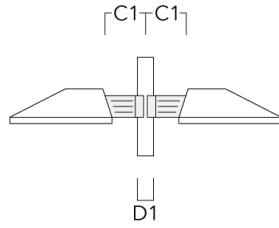

SK2-230 Pole clamp, double (Ø 102-114)	108-0477	175	102-114	3.20	175
--	----------	-----	---------	------	-----

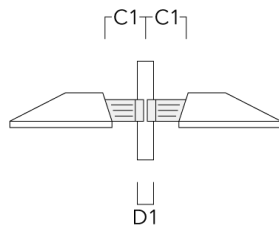

Optical Accessories**Light shield**

Description	Part ID	Additional information
LS180-[A60]	430-0038	Light shield LS180 to greatly reduce or eliminate light pollution. PA injection moulded component, black matt. Suitable for asymmetric light distribution [A60].
LS180	430-0029	Glare Shield for backlight spill. Glare Shield factory-installed or available as retrofit kit. Suitable for [S60], [S65], [S70], [R65], [P65] lenses. Must be specified at time of ordering.

108-1782

PFL230 LED

WE-EF LEUCHTEN GmbH

Töpinger Straße 16, 29646 Bispingen, Germany

Phone: +49 5194 909-0

info@we-ef.com

<https://we-ef.com>

Subject to technical changes and errors.

Generated on 23/10/2024