

108-1783

PFL230 LED

we-ef



Description

IP66, Class I. IK08. Marine-grade die-cast aluminium alloy. 5CE superior corrosion protection + primer including PCS hardware. Silicone rubber gaskets. Safety glass lens, hinged. PMMA OLC® optics for superior illumination and glare control. DALI.

Please note that the luminaire requires a mounting bracket for installation. This bracket needs to be ordered separately. Please choose from one of our various options listed under Mounting Accessories

Weight	10.00 kg
Light distribution	rectangular, side throw [R65]
Light source	LED-18/18W / 350 mA - 3000 K
CRI	80
Power supply	EC
LEDs	18
Rated input power	21 W

Nominal Lumen (lm)

LED Lumen	155
Total Lumen	2790
Tj	85

Rated lumens (lm)

LED Lumen	111.7
Total Lumen	2010.3
Ta	25

WE-EF LIGHTING Pty Ltd

6/13 Downard Street, 3195 Braeside, Victoria - Phone: +61 3 8587 0444 - Fax: +61 3 8587 0499

info.australia@we-ef.com - <https://we-ef.com/aus>

Subject to technical changes and errors. - Generated on 23/11/2024

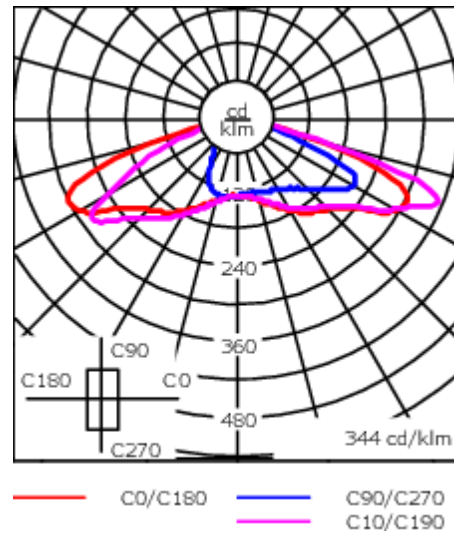
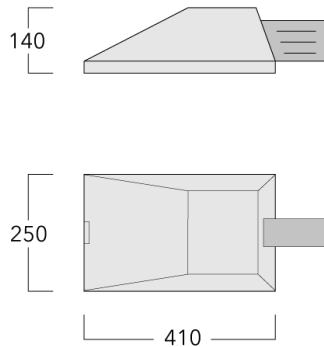

Specifications

Material description

Body	Marine-grade, die-cast aluminium alloy
Lens	Safety glass lens, hinged
Colours	<div style="display: flex; align-items: center;"> <div style="width: 20px; height: 15px; background-color: black; margin-right: 5px;"></div> <div>RAL9004 Signal black</div> </div> <div style="display: flex; align-items: center; margin-top: 5px;"> <div style="width: 20px; height: 15px; background-color: #cccccc; margin-right: 5px;"></div> <div>RAL9006 White aluminium</div> </div> <div style="display: flex; align-items: center; margin-top: 5px;"> <div style="width: 20px; height: 15px; background-color: #808080; margin-right: 5px;"></div> <div>RAL9007 Grey aluminium</div> </div>
Gasket	Silicone CCG® Controlled Compression Gasket
Fasteners	PCS Polymer Coated Stainless Steel Hardware (unpainted)
Ingress protection	IP66
Impact resistance	IK08
Corrosion resistance	5CE+Primer
Windage	0.042 m ²

Electrical description

Power supply	230V / 50 Hz
Driver / Ballast	Integral EC electronic converter. DALI
Power factor	> 0.9
Surge protection	In-pole surge protection SP10 device supplied. Please refer to WE-EF installation instructions for details. Use suffix +A for Integral surge protection.

WE-EF LIGHTING Pty Ltd

6/13 Downard Street, 3195 Braeside, Victoria - Phone: +61 3 8587 0444 - Fax: +61 3 8587 0499

info.australia@we-ef.com - <https://we-ef.com/aus>

Subject to technical changes and errors. - Generated on 23/11/2024

108-1783

PFL230 LED

we-ef

Additional information

Lifetime	Ta=40° L90B10 > 90000h
Warranty	The product is supplied with 10-year warranty. Please refer to the LED Warranty Statement located on www.we-ef.com for further details.

WE-EF LIGHTING Pty Ltd

6/13 Downard Street, 3195 Braeside, Victoria - Phone: +61 3 8587 0444 - Fax: +61 3 8587 0499

info.australia@we-ef.com - <https://we-ef.com/aus>

Subject to technical changes and errors. - Generated on 23/11/2024

108-1783

PFL230 LED

we-ef

Control

Eco Step Dim® Basic

Description	Part ID
Eco Step Dim® Basic LED	430-0001

Eco Step Dim® Advanced

Description	Part ID
Eco Step Dim® Advanced LED	430-0002

WE-EF LIGHTING Pty Ltd

6/13 Downard Street, 3195 Braeside, Victoria - Phone: +61 3 8587 0444 - Fax: +61 3 8587 0499

info.australia@we-ef.com - <https://we-ef.com/aus>

Subject to technical changes and errors. - Generated on 23/11/2024

Mounting Accessories

Wall and pole brackets KI

Description	Part ID	A	C1	D1	D2	D × L1	H1	M1	Weight (kg)	Alpha	C	D	H
KI0-230 Wall bracket	108-0430	±30°	210	180	148			6.5	3.00	± 3°	210	180	180

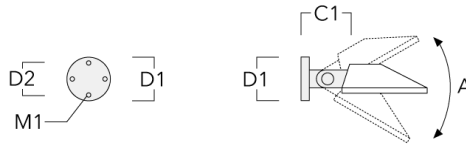

KI1-230 Pole bracket, single	108-0431	±30°	210			76 x 80	475		4.30	± 3°	210		475
------------------------------	----------	------	-----	--	--	---------	-----	--	------	------	-----	--	-----

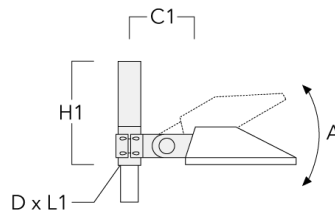

Description	Part ID	A	C1	D1	D2	D × L1	H1	M1	Weight (kg)	Alpha	C	D	H
KI2-230 Pole bracket, double	108-0432	±30°	210			76 x 80	475		6	± 3°	210		475

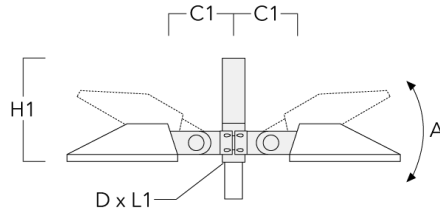

Wall and pole brackets KP

Description	Part ID	C1	D1	D2	D × L1	H1	M1	Weight (kg)	C	D	H
KP0-230 Wall bracket	108-0433	195	180	140			12	1.50	175	180	180

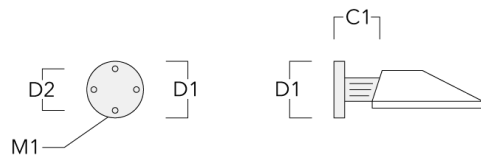

PFL230 LED

Description	Part ID	C1	D1	D2	D x L1	H1	M1	Weight (kg)	C	D	H
KP1-230 Pole bracket, single	108-0434	210			76 x 80	525		3.60	175		525

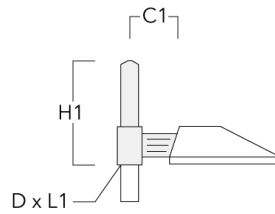

KP2-230 Pole bracket, double	108-0435	210			76 x 80	525		4.30	175		525
------------------------------	----------	-----	--	--	---------	-----	--	------	-----	--	-----

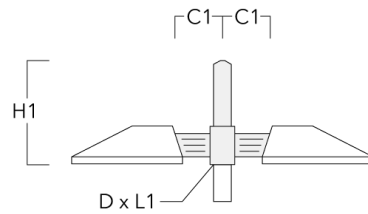

Pole brackets KP_L

Description	Part ID	C1	D x L1	H1	Weight (kg)	C	H
KP1-L-230 Pole bracket, single	108-0713	450	76 x 130	525	6.30	175	525

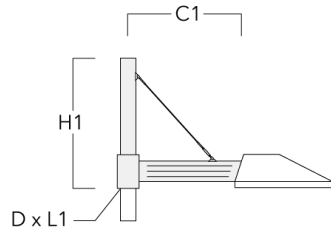

KP2-L-230 Pole bracket, double	108-0714	450	76 x 130	525	9.50	175	525
--------------------------------	----------	-----	----------	-----	------	-----	-----

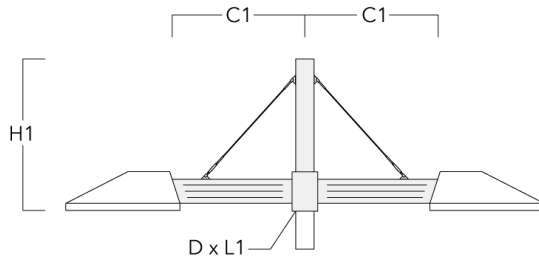

Pole brackets KY

Description	Part ID	A	C1	D x L1	H1	Weight (kg)	Alpha	C	H
KY1-230 Pole bracket, single	108-0496	±30°	210	76 x 80	730	8.20	± 3°	210	525

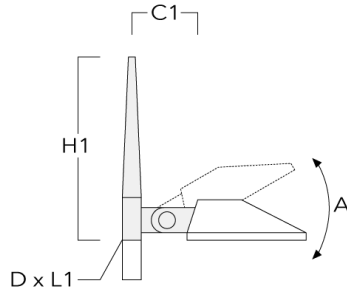

KY2-230 Pole bracket, double	108-0497	±30°	210	76 x 80	730	9.40	± 3°	210	525
------------------------------	----------	------	-----	---------	-----	------	------	-----	-----

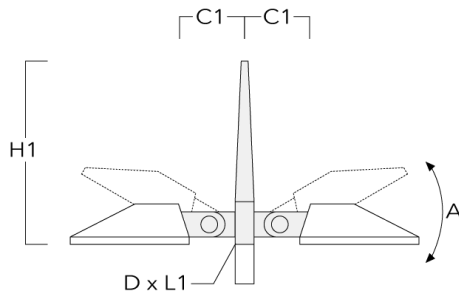

108-1783

PFL230 LED

we-ef

Pole clamp SI

Description	Part ID	C1	D1	Weight (kg)	C
SI1-230 Pole clamp, single (Ø 76-89)	108-0478	210	76-89	2.90	210

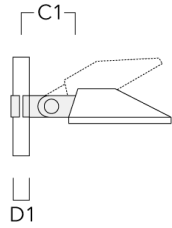

SI1-230 Pole clamp, single (Ø 102-114)	108-0479	210	102-114	3.10	210
--	----------	-----	---------	------	-----

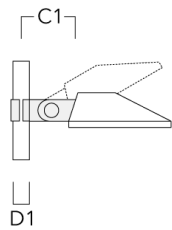

PFL230 LED

Description	Part ID	C1	D1	Weight (kg)	C
SI2-230 Pole clamp, double (Ø 76-89)	108-0480	210	76-89	4.50	210

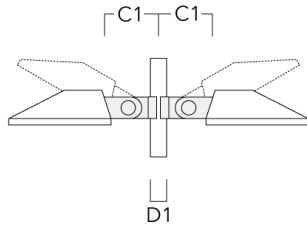

SI2-230 Pole clamp, double (Ø 102-114)	108-0481	210	102-114	4.70	210
--	----------	-----	---------	------	-----

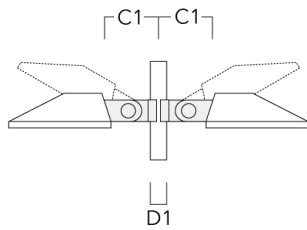

108-1783

PFL230 LED

we-ef

Pole clamp SK

Description	Part ID	C1	D1	Weight (kg)	C
SK1-230 Pole clamp, single (Ø 76-89)	108-0474	175	76-89	2.10	175

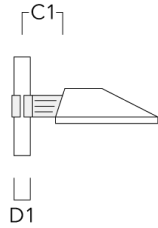

SK1-230 Pole clamp, single (Ø 102-114)	108-0475	175	102-114	2.40	175
--	----------	-----	---------	------	-----

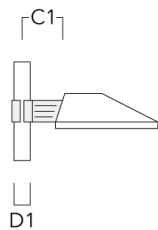

WE-EF LIGHTING Pty Ltd

6/13 Downard Street, 3195 Braeside, Victoria - Phone: +61 3 8587 0444 - Fax: +61 3 8587 0499

info.australia@we-ef.com - <https://we-ef.com/aus>

Subject to technical changes and errors. - Generated on 23/11/2024

PFL230 LED

Description	Part ID	C1	D1	Weight (kg)	C
SK2-230 Pole clamp, double (Ø 76-89)	108-0476	175	76-89	2.90	175

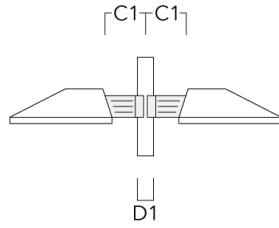

SK2-230 Pole clamp, double (Ø 102-114)	108-0477	175	102-114	3.20	175
--	----------	-----	---------	------	-----

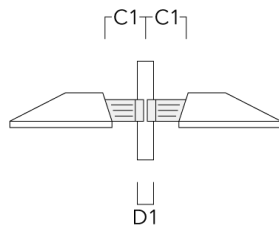

108-1783

PFL230 LED

we-ef

Optical Accessories

Light shield

Description	Part ID	Additional information
LS180-[A60]	003-4018	Glare Shield for backlight spill. Glare Shield factory-installed or available as retrofit kit. Suitable for [A60] lenses. Must be specified at time of ordering.
LS180	003-4019	Glare Shield for backlight spill. Glare Shield factory-installed or available as retrofit kit. Suitable for [S60], [S65], [S70], [R65], [P65] lenses. Must be specified at time of ordering.

WE-EF LIGHTING Pty Ltd

6/13 Downard Street, 3195 Braeside, Victoria - Phone: +61 3 8587 0444 - Fax: +61 3 8587 0499

info.australia@we-ef.com - <https://we-ef.com/aus>

Subject to technical changes and errors. - Generated on 23/11/2024