

108-1777

PFL230 LED

we-ef



Description

IP66 in both an upward or downward orientation. Class I. IK08. Marine-grade, die-cast aluminum alloy. 5CE superior corrosion protection including PCS hardware. Silicone CCG® Controlled Compression Gasket. Safety glass lens, hinged frame. Luminaire is factory-wired and supplied with 30' of black, three conductor, flexible SEOW cord for power connection at pole-base hand hole. PMMA optics for superior illumination and glare control. OLC® One LED Concept. 0-10V Dimming comes standard with luminaire.

Recommended mounting height 10-20 ft, depending on wattage selected; mounting bracket required.

Specify product with 7 Digit product code - Finish Color. Accessories, such as mounting, optical, and electrical, must be specified separately.

Example: XXX-XXXX-9004 (Black)
+ XXX-XXXX (Accessory 1)

Weight	22.00 lb
Light distribution	[A60] Type IV Very Short
Light source	LED-12/12W / 350 mA - 3000 K
CRI	80
Power supply	electronic gear
BUG	B0 U0 G0
LEDs	12
Rated input power	13.9 W

Nominal Lumen (lm)

LED Lumen	155
Total Lumen	1860
Tj	85

Rated lumens (lm)

LED Lumen	119.6
Total Lumen	1434.9
Ta	25

WE-EF LIGHTING USA, LLC

410-D Keystone Drive, 15086 Warrendale, PA 15086 - Phone: +1 724 742 0030
customersupport.usa@we-ef.com - <https://we-ef.com/us>
Subject to technical changes and errors. - Generated on 11/23/2024

108-1777

PFL230 LED

we-ef

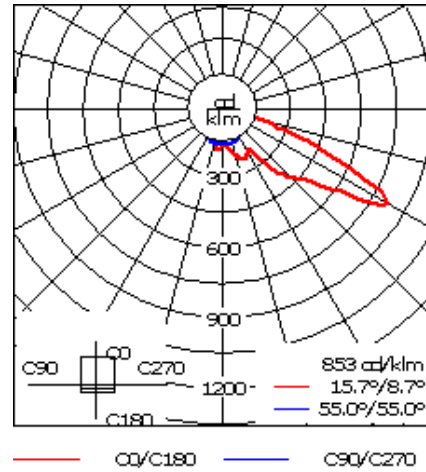
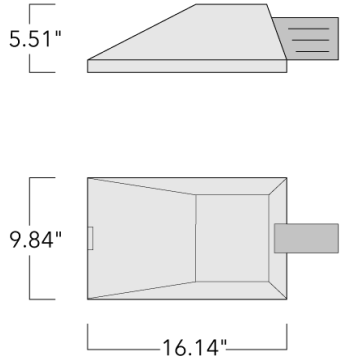

Specifications

Material description

Body	Marine-grade, die-cast aluminium alloy
Lens	Safety glass lens, hinged
Colors	<div style="display: flex; flex-direction: column; gap: 5px;"> <div> RAL9004 Black</div> <div> RAL9007 Grey Metallic</div> <div> RAL9016 White</div> <div> RAL8019 Dark Bronze</div> </div>
Gasket	Silicone CCG® Controlled Compression Gasket
Fasteners	PCS Polymer Coated Stainless Steel Hardware
Ingress protection	IP66
Impact resistance	IK08
Corrosion resistance	5CE superior corrosion protection system
Windage	0.45 ft ²

WE-EF LIGHTING USA, LLC

410-D Keystone Drive, 15086 Warrendale, PA 15086 - Phone: +1 724 742 0030

customersupport.usa@we-ef.com - <https://we-ef.com/us>

Subject to technical changes and errors. - Generated on 11/23/2024

108-1777

PFL230 LED

we-ef

Electrical description

Power supply	Integral [ECG] electronic driver 120V-277V. 0-10V dimmable, to be specified with order.
Driver / Ballast	Integral EC electronic converter
Power factor	> 0.9
Surge protection	Integral 10kV Surge Protector

Additional information

Lifetime	Ta=25°/40° L90B10 > 90000h
BUG Rating	Please see individual Spec Sheets for classification of Backlight, Uplight and Glare.
Listings	ETL, UL-1598, CSA-C22.2#250.0. Suitable for Wet Locations.

WE-EF LIGHTING USA, LLC

410-D Keystone Drive, 15086 Warrendale, PA 15086 - Phone: +1 724 742 0030
customersupport.usa@we-ef.com - <https://we-ef.com/us>
Subject to technical changes and errors. - Generated on 11/23/2024

108-1777

we-ef

PFL230 LED

Mounting Accessories

Wall and pole brackets KI

Description	Part ID	A	C1	D1	D2	D × L1	H1	L	M1	Weight (lb)	Alpha	C	D	H
K10-230 Wall bracket	108-0430	±30°	8.27	7.09	5.83				0.26	6.61	± 3°	210	180	180

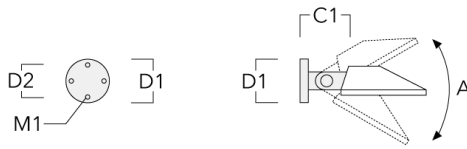

K11-230 Pole bracket, single	108-0431	±30°	8.27			3 x 3	18.70	2.99		9.48	± 3°	210		475
------------------------------	----------	------	------	--	--	-------	-------	------	--	------	------	-----	--	-----

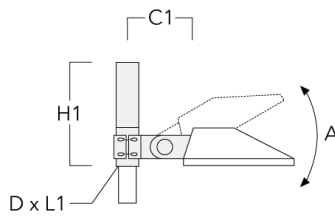

WE-EF LIGHTING USA, LLC

410-D Keystone Drive, 15086 Warrendale, PA 15086 - Phone: +1 724 742 0030
customersupport.usa@we-ef.com - <https://we-ef.com/us>

Subject to technical changes and errors. - Generated on 11/23/2024

PFL230 LED

Description	Part ID	A	C1	D1	D2	D × L1	H1	L	M1	Weight (lb)	Alpha	C	D	H
K12-230 Pole bracket, double	108-0432	±30°	8.27			3 x 3	18.70	2.99		9.48	± 3°	210		475

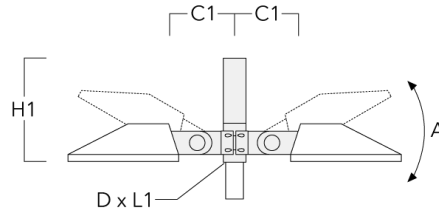

Wall and pole brackets KP

Description	Part ID	C1	D1	D2	D × L1	H1	L	M1	Weight (lb)	C	D	H
KP0-230 Wall bracket	108-0433	7.68	7.09	5.51				0.47	3.31	175	180	180

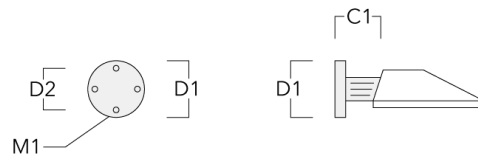

WE-EF LIGHTING USA, LLC

410-D Keystone Drive, 15086 Warrendale, PA 15086 - Phone: +1 724 742 0030

customersupport.usa@we-ef.com - <https://we-ef.com/us>

Subject to technical changes and errors. - Generated on 11/23/2024

PFL230 LED

Description	Part ID	C1	D1	D2	D x L1	H1	L	M1	Weight (lb)	C	D	H
KP1-230 Pole bracket, single	108-0434	8.27			3 x 3	20.67	2.99		7.94	175		525

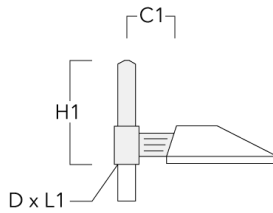

KP2-230 Pole bracket, double	108-0435	8.27			3 x 3	20.67	2.99		9.48	175		525
------------------------------	----------	------	--	--	-------	-------	------	--	------	-----	--	-----

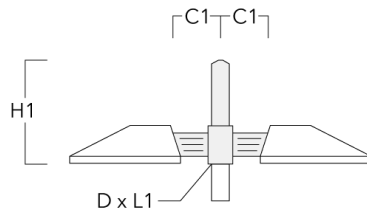

WE-EF LIGHTING USA, LLC

410-D Keystone Drive, 15086 Warrendale, PA 15086 - Phone: +1 724 742 0030
 customersupport.usa@we-ef.com - <https://we-ef.com/us>

Subject to technical changes and errors. - Generated on 11/23/2024

Pole brackets KP_L

Description	Part ID	C1	D x L1	H1	L	Weight (lb)	C	H
KP1-L-230 Pole bracket, single	108-0713	17.72	3 x 5	20.67	2.99	13.89	175	525

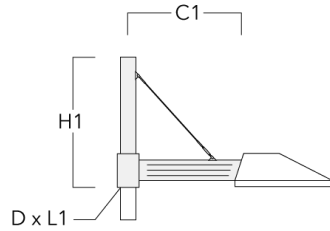

KP2-L-230 Pole bracket, double	108-0714	17.72	3 x 5	20.67	2.99	20.94	175	525
--------------------------------	----------	-------	-------	-------	------	-------	-----	-----

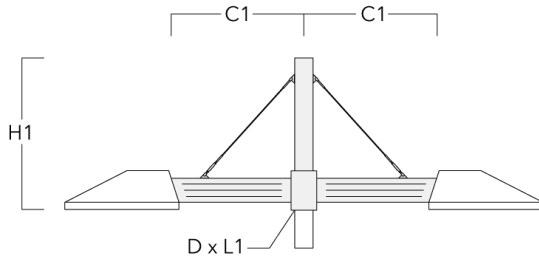

WE-EF LIGHTING USA, LLC

410-D Keystone Drive, 15086 Warrendale, PA 15086 - Phone: +1 724 742 0030
 customersupport.usa@we-ef.com - <https://we-ef.com/us>

Subject to technical changes and errors. - Generated on 11/23/2024

Pole brackets KY

Description	Part ID	A	C1	D x L1	H1	L	Weight(lb)	Alpha	C	H
KY1-230 Pole bracket, single	108-0496	±30°	8.27	3 x 3	28.74	2.99	18.08	± 3°	210	525

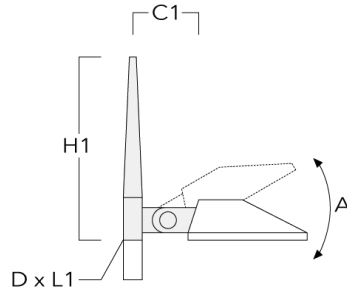

KY2-230 Pole bracket, double	108-0497	±30°	8.27	3 x 3	36.61	2.99	20.72	± 3°	210	525
------------------------------	----------	------	------	-------	-------	------	-------	------	-----	-----

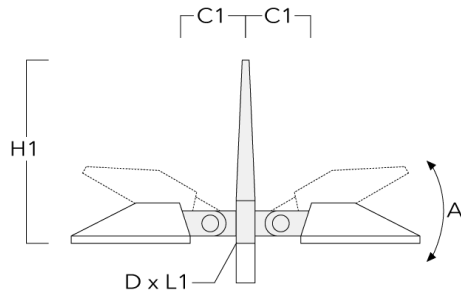

WE-EF LIGHTING USA, LLC

410-D Keystone Drive, 15086 Warrendale, PA 15086 - Phone: +1 724 742 0030

customersupport.usa@we-ef.com - <https://we-ef.com/us>

Subject to technical changes and errors. - Generated on 11/23/2024

108-1777

we-ef

PFL230 LED

Pole clamp SI

Description	Part ID	C1	D1	Weight (lb)	C
S11-230 Pole clamp, single (Ø 3"-3.5")	108-0478	8.27	3.0-3.50	6.39	210

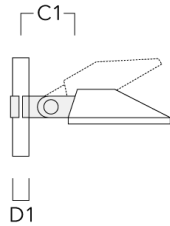

S11-230 Pole clamp, single (Ø 4"-4.5")	108-0479	8.27	4.0-4.50	6.83	210
--	----------	------	----------	------	-----

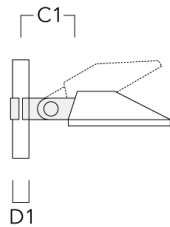

WE-EF LIGHTING USA, LLC

410-D Keystone Drive, 15086 Warrendale, PA 15086 - Phone: +1 724 742 0030
customersupport.usa@we-ef.com - <https://we-ef.com/us>

Subject to technical changes and errors. - Generated on 11/23/2024

PFL230 LED

Description	Part ID	C1	D1	Weight (lb)	C
SI2-230 Pole clamp, double (Ø 3"-3.5")	108-0480	8.27	3.0-3.50	9.92	210

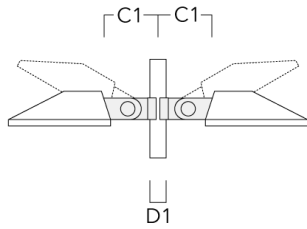

SI2-230 Pole clamp, double (Ø 4"-4.5")	108-0481	8.27	4.0-4.50	10.36	210
--	----------	------	----------	-------	-----

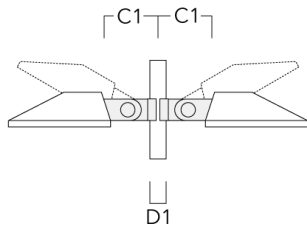

WE-EF LIGHTING USA, LLC

410-D Keystone Drive, 15086 Warrendale, PA 15086 - Phone: +1 724 742 0030
customersupport.usa@we-ef.com - <https://we-ef.com/us>

Subject to technical changes and errors. - Generated on 11/23/2024

108-1777

we-ef

PFL230 LED

Pole clamp SK

Description	Part ID	C1	D1	Weight (lb)	C
SK1-230 Pole clamp, single (Ø 3"-3.5")	108-0474	6.89	3.0-3.50	4.63	175

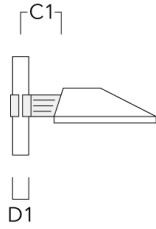

SK1-230 Pole clamp, single (Ø 4"-4.5")	108-0475	6.89	4.0-4.50	5.29	175
--	----------	------	----------	------	-----

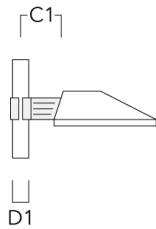

WE-EF LIGHTING USA, LLC

410-D Keystone Drive, 15086 Warrendale, PA 15086 - Phone: +1 724 742 0030
customersupport.usa@we-ef.com - <https://we-ef.com/us>
Subject to technical changes and errors. - Generated on 11/23/2024

108-1777

we-ef

PFL230 LED

Description	Part ID	C1	D1	Weight (lb)	C
SK2-230 Pole clamp, double (Ø 3"-3.5")	108-0476	6.89	3.0-3.50	6.39	175

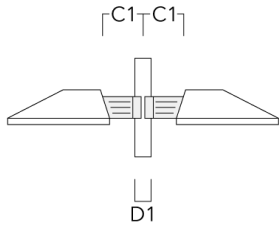

SK2-230 Pole clamp, double (Ø 4"-4.5")	108-0477	6.89	4.0-4.50	7.05	175
--	----------	------	----------	------	-----

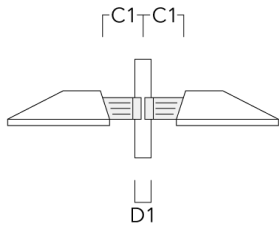

WE-EF LIGHTING USA, LLC

410-D Keystone Drive, 15086 Warrendale, PA 15086 - Phone: +1 724 742 0030
customersupport.usa@we-ef.com - <https://we-ef.com/us>

Subject to technical changes and errors. - Generated on 11/23/2024

108-1777

PFL230 LED

we-ef

Optical Accessories

Light shield

Description	Part ID	Additional information
LS180-[A60]	430-0038	Light shield LS180 to greatly reduce or eliminate light pollution. PA injection moulded component, black matt. Suitable for asymmetric light distribution [A60].
LS180	430-0029	Glare Shield for backlight spill. Glare Shield factory-installed or available as retrofit kit. Suitable for [S60], [S65], [S70], [R65], [P65] lenses. Must be specified at time of ordering.

WE-EF LIGHTING USA, LLC

410-D Keystone Drive, 15086 Warrendale, PA 15086 - Phone: +1 724 742 0030

customersupport.usa@we-ef.com - <https://we-ef.com/us>

Subject to technical changes and errors. - Generated on 11/23/2024