



Description

IP66, Class I. IK08. Marine-grade die-cast aluminium alloy. 5CE superior corrosion protection + primer including PCS hardware. Silicone rubber gaskets. Safety glass lens, hinged. PMMA OLC® optics for superior illumination and glare control. DALI.

Please note that the luminaire requires a mounting bracket for installation. This bracket needs to be ordered separately. Please choose from one of our various options listed under Mounting Accessories

Weight	10.00 kg
Light distribution	pedestrian/bicycle lane [P65]
Light source	LED-12/12W / 350 mA - 3000 K
CRI	80
Power supply	EC
LEDs	12
Rated input power	13.9 W

Nominal Lumen (lm)

LED Lumen	155
Total Lumen	1860
Tj	85

Rated lumens (lm)

LED Lumen	120.9
Total Lumen	1450.4
Ta	25

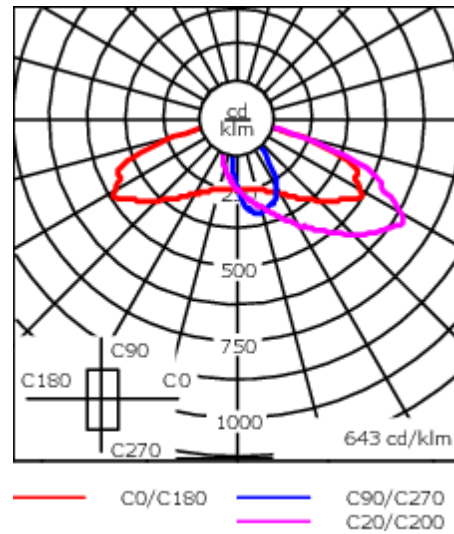
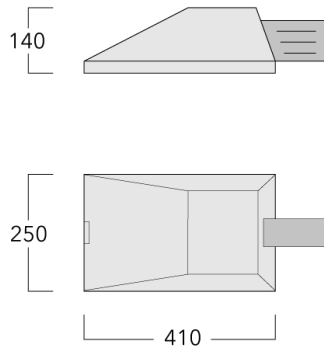

Specifications

Material description

Body	Marine-grade, die-cast aluminium alloy
Lens	Safety glass lens, hinged
Colours	<div style="display: flex; align-items: center;"> <div style="width: 20px; height: 15px; background-color: black; margin-right: 5px;"></div> RAL9004 Signal black </div> <div style="display: flex; align-items: center; margin-top: 5px;"> <div style="width: 20px; height: 15px; background-color: #cccccc; margin-right: 5px;"></div> RAL9006 White aluminium </div> <div style="display: flex; align-items: center; margin-top: 5px;"> <div style="width: 20px; height: 15px; background-color: #808080; margin-right: 5px;"></div> RAL9007 Grey aluminium </div>
Gasket	Silicone CCG® Controlled Compression Gasket
Fasteners	PCS Polymer Coated Stainless Steel Hardware (unpainted)
Ingress protection	IP66
Impact resistance	IK08
Corrosion resistance	5CE+Primer
Windage	0.042 m ²

Electrical description

Power supply	230V / 50 Hz
Driver / Ballast	Integral EC electronic converter. DALI
Power factor	> 0.9
Surge protection	In-pole surge protection SP10 device supplied. Please refer to WE-EF installation instructions for details. Use suffix +A for Integral surge protection.

WE-EF LIGHTING Pty Ltd

6/13 Downard Street, 3195 Braeside, Victoria - Phone: +61 3 8587 0444 - Fax: +61 3 8587 0499

info.australia@we-ef.com - <https://we-ef.com/aus>

Subject to technical changes and errors. - Generated on 23/11/2024

108-1779

PFL230 LED

we-ef

Additional information

Lifetime	Ta=40° L90B10 > 90000h
Warranty	The product is supplied with 10-year warranty. Please refer to the LED Warranty Statement located on www.we-ef.com for further details.

WE-EF LIGHTING Pty Ltd

6/13 Downard Street, 3195 Braeside, Victoria - Phone: +61 3 8587 0444 - Fax: +61 3 8587 0499

info.australia@we-ef.com - <https://we-ef.com/aus>

Subject to technical changes and errors. - Generated on 23/11/2024

108-1779

PFL230 LED

we-ef

Control

Eco Step Dim® Basic

Description	Part ID
Eco Step Dim® Basic LED	430-0001

Eco Step Dim® Advanced

Description	Part ID
Eco Step Dim® Advanced LED	430-0002

WE-EF LIGHTING Pty Ltd

6/13 Downard Street, 3195 Braeside, Victoria - Phone: +61 3 8587 0444 - Fax: +61 3 8587 0499

info.australia@we-ef.com - <https://we-ef.com/aus>

Subject to technical changes and errors. - Generated on 23/11/2024

Mounting Accessories

Wall and pole brackets KI

Description	Part ID	A	C1	D1	D2	D × L1	H1	M1	Weight (kg)	Alpha	C	D	H
KI0-230 Wall bracket	108-0430	±30°	210	180	148			6.5	3.00	± 3°	210	180	180

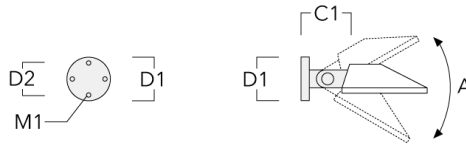

KI1-230 Pole bracket, single	108-0431	±30°	210			76 x 80	475		4.30	± 3°	210		475
------------------------------	----------	------	-----	--	--	---------	-----	--	------	------	-----	--	-----



PFL230 LED

Description	Part ID	A	C1	D1	D2	D × L1	H1	M1	Weight (kg)	Alpha	C	D	H
KI2-230 Pole bracket, double	108-0432	±30°	210			76 x 80	475		6	± 3°	210		475

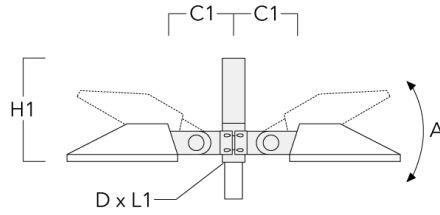

Wall and pole brackets KP

Description	Part ID	C1	D1	D2	D × L1	H1	M1	Weight (kg)	C	D	H
KP0-230 Wall bracket	108-0433	195	180	140			12	1.50	175	180	180

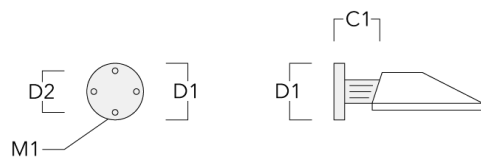

PFL230 LED

Description	Part ID	C1	D1	D2	D x L1	H1	M1	Weight (kg)	C	D	H
KP1-230 Pole bracket, single	108-0434	210			76 x 80	525		3.60	175		525



KP2-230 Pole bracket, double	108-0435	210			76 x 80	525		4.30	175		525
------------------------------	----------	-----	--	--	---------	-----	--	------	-----	--	-----



Pole brackets KP_L

Description	Part ID	C1	D x L1	H1	Weight (kg)	C	H
KP1-L-230 Pole bracket, single	108-0713	450	76 x 130	525	6.30	175	525

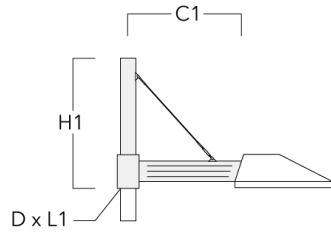

KP2-L-230 Pole bracket, double	108-0714	450	76 x 130	525	9.50	175	525
--------------------------------	----------	-----	----------	-----	------	-----	-----

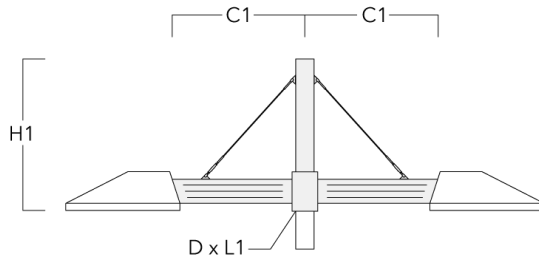

Pole brackets KY

Description	Part ID	A	C1	D x L1	H1	Weight (kg)	Alpha	C	H
KY1-230 Pole bracket, single	108-0496	±30°	210	76 x 80	730	8.20	± 3°	210	525

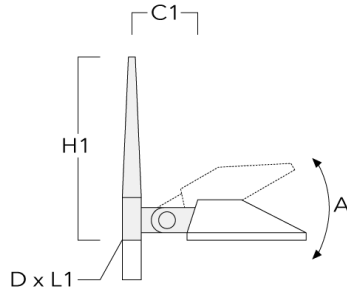

KY2-230 Pole bracket, double	108-0497	±30°	210	76 x 80	730	9.40	± 3°	210	525
------------------------------	----------	------	-----	---------	-----	------	------	-----	-----

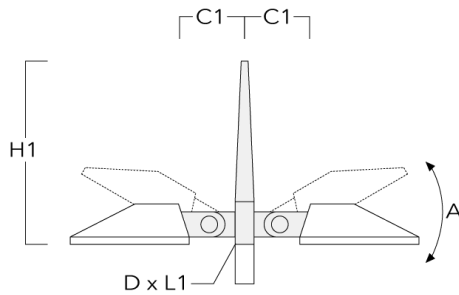

108-1779

PFL230 LED

we-ef

Pole clamp SI

Description	Part ID	C1	D1	Weight (kg)	C
SI1-230 Pole clamp, single (Ø 76-89)	108-0478	210	76-89	2.90	210

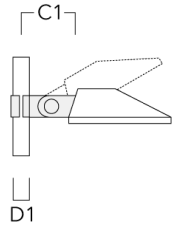

SI1-230 Pole clamp, single (Ø 102-114)	108-0479	210	102-114	3.10	210
--	----------	-----	---------	------	-----

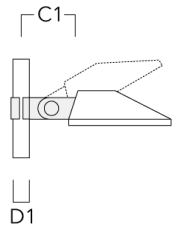

PFL230 LED

Description	Part ID	C1	D1	Weight (kg)	C
SI2-230 Pole clamp, double (Ø 76-89)	108-0480	210	76-89	4.50	210



SI2-230 Pole clamp, double (Ø 102-114)	108-0481	210	102-114	4.70	210
--	----------	-----	---------	------	-----



108-1779

PFL230 LED

we-ef

Pole clamp SK

Description	Part ID	C1	D1	Weight (kg)	C
SK1-230 Pole clamp, single (Ø 76-89)	108-0474	175	76-89	2.10	175

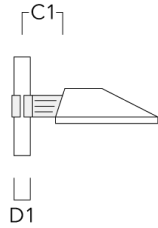

SK1-230 Pole clamp, single (Ø 102-114)	108-0475	175	102-114	2.40	175
--	----------	-----	---------	------	-----



PFL230 LED

Description	Part ID	C1	D1	Weight (kg)	C
SK2-230 Pole clamp, double (Ø 76-89)	108-0476	175	76-89	2.90	175



SK2-230 Pole clamp, double (Ø 102-114)	108-0477	175	102-114	3.20	175
--	----------	-----	---------	------	-----



Optical Accessories**Light shield**

Description	Part ID	Additional information
LS180-[A60]	003-4018	Glare Shield for backlight spill. Glare Shield factory-installed or available as retrofit kit. Suitable for [A60] lenses. Must be specified at time of ordering.
LS180	003-4019	Glare Shield for backlight spill. Glare Shield factory-installed or available as retrofit kit. Suitable for [S60], [S65], [S70], [R65], [P65] lenses. Must be specified at time of ordering.