

108-1724

PFL230 LED

**we-ef**



### Description

IP66. Classe I. Classe II sur demande. IK08. Corps en fonte d'aluminium. Visserie inox avec traitement PCS. Protection contre la corrosion 5CE. CCG® joint silicone. Vitre RFC® monté dans un cadre aluminium suspendable. Modules LED interchangeables avec dissipateur de chaleur. Lentille PMMA avec technologie OLC® pour la maîtrise du flux et la précision de l'éclairage. Option : Fixation latérale (voir accessoires de montage) Hauteur de mât recommandée selon la puissance: 2 à 8m.

Version en 2200K disponible. À préciser lors de la demande de devis.

Poids	10.00 kg
Distribution de la lumière	[S65] Eclairage routier - basses luminances
Source lumineuse	LED-18/36W / 700 mA - 4000 K
IRC	80
Alimentation électrique	ballast électronique
LEDs	18
Rated input power	41 W

### Flux lumineux nominal (lm)

LED Lumen	310
Total Lumen	5580
Tj	85

### Rated lumens (lm)

LED Lumen	247.7
Total Lumen	4458.1
Ta	25

### WE-EF Switzerland AG

Himmelrichstrasse 6, 6003 Luzern - Téléphone: +41 22 752 49 94

info.switzerland@we-ef.com - [https://we-ef.com/ch\\_fr](https://we-ef.com/ch_fr)

Sous réserve de modifications techniques et d'erreurs. - Généré le 23/11/2024

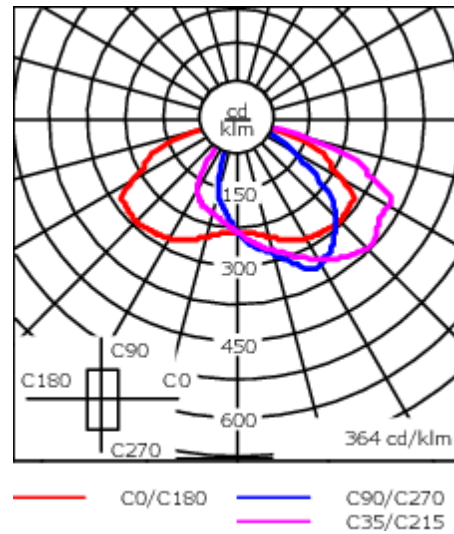
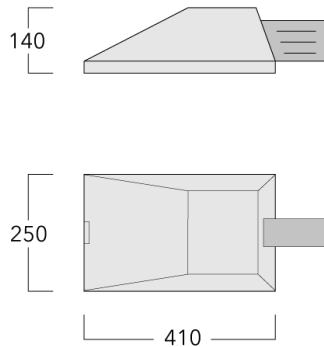

## Spécifications

### Description du matériel

Corps	Corps en fonte d'aluminium, visserie inox avec traitement PCS
Lentille	Verre de sécurité sur charnière
Couleurs	<div style="display: flex; align-items: center; gap: 10px;"> <div style="width: 20px; height: 10px; background-color: black; margin-right: 5px;"></div> RAL9004 Noir de sécurité         </div> <div style="display: flex; align-items: center; gap: 10px; margin-top: 5px;"> <div style="width: 20px; height: 10px; background-color: gray; margin-right: 5px;"></div> RAL9007 Aluminium gris         </div> <div style="display: flex; align-items: center; gap: 10px; margin-top: 5px;"> <div style="width: 20px; height: 10px; background-color: darkgray; margin-right: 5px;"></div> RAL7016 Gris anthracite         </div> <div style="display: flex; align-items: center; gap: 10px; margin-top: 5px;"> <div style="width: 20px; height: 10px; background-color: lightgray; margin-right: 5px;"></div> RAL9016 Blanc signalisation         </div>
Joint	Joint silicone CCG®
Visserie	PCS Inox avec recouvrement polymère
IP	IP66
IK	IK08
Protection contre la corrosion	5CE
Surface exposée au vent	0.042 m <sup>2</sup>

### Description électrique

Alimentation électrique	220-240V / 50-60 Hz
Driver	Driver électronique. DALI
Power factor	> 0.9

#### WE-EF Switzerland AG

Himmelrichstrasse 6, 6003 Luzern - Téléphone: +41 22 752 49 94

info.switzerland@we-ef.com - [https://we-ef.com/ch\\_fr](https://we-ef.com/ch_fr)

Sous réserve de modifications techniques et d'erreurs. - Généré le 23/11/2024

**108-1724**

**PFL230 LED**

**we-ef**

### **Informations complémentaires**

---

Durée de vie Ta=25° L90B10 > 90000h

Classe d'efficacité  
énergétique C-D

---

**WE-EF Switzerland AG**

Himmelrichstrasse 6, 6003 Luzern - Téléphone: +41 22 752 49 94

info.switzerland@we-ef.com - [https://we-ef.com/ch\\_fr](https://we-ef.com/ch_fr)

Sous réserve de modifications techniques et d'erreurs. - Généré le 23/11/2024

**108-1724**

**PFL230 LED**

**we-ef**

## **Control**

### **Eco Step Dim® Basic**

Description	Référence
Eco Step Dim® Basic LED	430-0001

### **Eco Step Dim® Advanced**

Description	Référence
Eco Step Dim® Advanced LED	430-0002

**WE-EF Switzerland AG**

Himmelrichstrasse 6, 6003 Luzern - Téléphone: +41 22 752 49 94

info.switzerland@we-ef.com - [https://we-ef.com/ch\\_fr](https://we-ef.com/ch_fr)

Sous réserve de modifications techniques et d'erreurs. - Généré le 23/11/2024

## Accessoires d'installation

## Crosses murales et Crosses pour mât KI

Description	Référence	A	C1	D1	D2	D × L1	H1	M1	Poids (kg)	Alpha	C	D	H
KI0-230 crosse murale	108-0430	±30°	210	180	148			6.5	3.00	± 3°	210	180	180

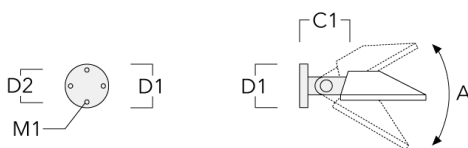

KI1-230 crosse simple réglable	108-0431	±30°	210			76 x 80	475		4.30	± 3°	210		475
--------------------------------	----------	------	-----	--	--	---------	-----	--	------	------	-----	--	-----

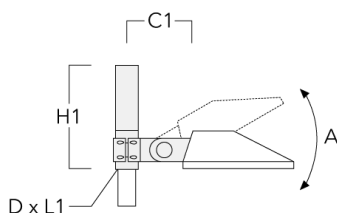

Description	Référence	A	C1	D1	D2	D × L1	H1	M1	Poids (kg)	Alpha	C	D	H
KI2-230 crosse double réglable	108-0432	±30°	210			76 x 80	475		6	± 3°	210		475

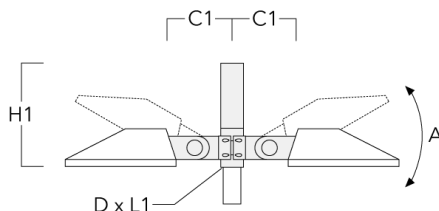

### Crosses murales et Crosses pour mât KP

Description	Référence	C1	D1	D2	D × L1	H1	M1	Poids (kg)	C	D	H
KP0-230 crosse murale	108-0433	195	180	140			12	1.50	175	180	180

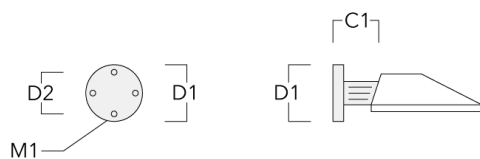

Description	Référence	C1	D1	D2	D x L1	H1	M1	Poids (kg)	C	D	H
KP1-230 crosse simple	108-0434	210			76 x 80	525		3.60	175		525

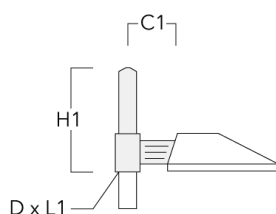

KP2-230 crosse simple	108-0435	210			76 x 80	525		4.30	175		525
-----------------------	----------	-----	--	--	---------	-----	--	------	-----	--	-----

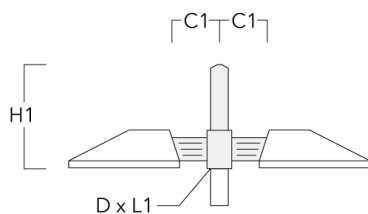

## Crosses murales et Crosses pour mât KP\_L

Description	Référence	C1	D x L1	H1	Poids (kg)	C	H
KP1-L-230 crose simple longue	108-0713	450	76 x 130	525	6.30	175	525

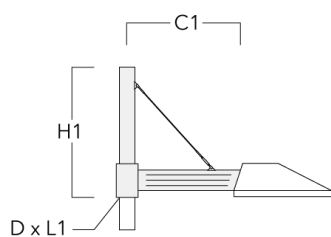

KP2-L-230 crose double longue	108-0714	450	76 x 130	525	9.50	175	525
-------------------------------	----------	-----	----------	-----	------	-----	-----

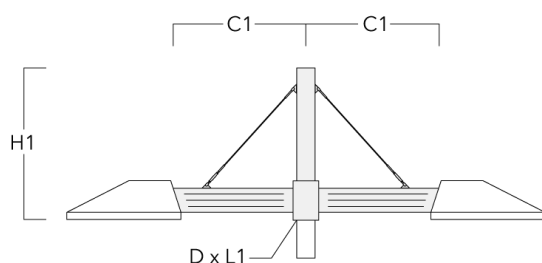



## Crosses pour mât KY

Description	Référence	A	C1	D x L1	H1	Poids (kg)	Alpha	C	H
KY1-230 crose simple réglable	108-0496	$\pm 30^\circ$	210	76 x 80	730	8.20	$\pm 3^\circ$	210	525

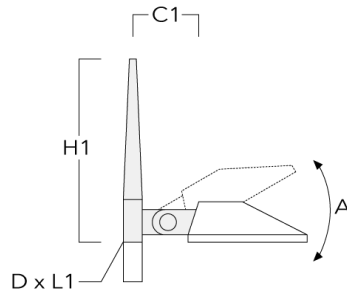

KY2-230 crose double réglable	108-0497	$\pm 30^\circ$	210	76 x 80	730	9.40	$\pm 3^\circ$	210	525
-------------------------------	----------	----------------	-----	---------	-----	------	---------------	-----	-----

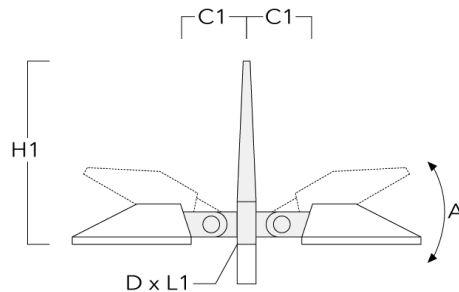

## Collier pour mâts SI

Description	Référence	C1	D1	Poids (kg)	C
SI1-230 collier de (Ø 76-89)	108-0478	210	76-89	2.90	210

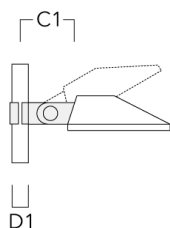

SI1-230 collier de (Ø 102-114)	108-0479	210	102-114	3.10	210
--------------------------------	----------	-----	---------	------	-----

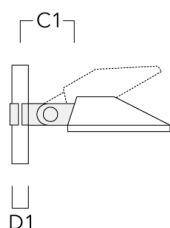

Description	Référence	C1	D1	Poids (kg)	C
SI2-230 collier de (Ø 76-89)	108-0480	210	76-89	4.50	210

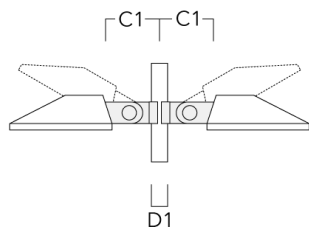

SI2-230 collier de (Ø 102-114)	108-0481	210	102-114	4.70	210
--------------------------------	----------	-----	---------	------	-----

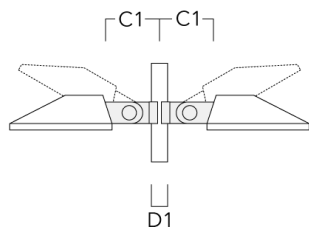

## Collier pour mâts SK

Description	Référence	C1	D1	Poids (kg)	C
SK1-230 collier de (Ø 76-89)	108-0474	175	76-89	2.10	175

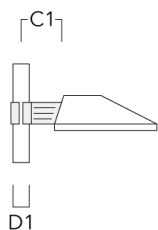

SK1-230 collier de (Ø 102-114)	108-0475	175	102-114	2.40	175
--------------------------------	----------	-----	---------	------	-----

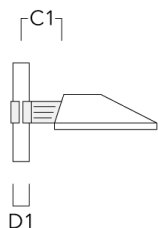

Description	Référence	C1	D1	Poids (kg)	C
SK2-230 collier de (Ø 76-89)	108-0476	175	76-89	2.90	175

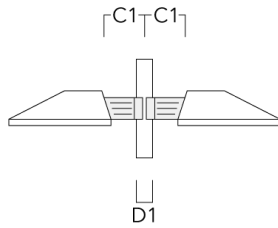

SK2-230 collier de (Ø 102-114)	108-0477	175	102-114	3.20	175
--------------------------------	----------	-----	---------	------	-----

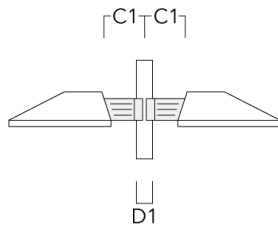

## Accessoires Optiques

### Light shield

Description	Référence	Informations complémentaires
LS180-[A60]	430-0038	Light shield LS180 to greatly reduce or eliminate light pollution. PA injection moulded component, black matt. Suitable for asymmetric light distribution [A60].
LS180	430-0029	Coupe-flux arrière adapté pour les optiques [S60], [S65], [S70], [R65], [P65]. Coupe-flux arrière assemblé sur le luminaire en usine ou disponible pour le rétrofit. Cela doit être déterminé à la commande.