

108-1622

PFL230 LED

we-ef



Description

IP66 in both an upward or downward orientation. Class I. IK08. Marine-grade, die-cast aluminum alloy. 5CE superior corrosion protection including PCS hardware. Silicone CCG® Controlled Compression Gasket. Safety glass lens, hinged frame. Luminaire is factory-wired and supplied with 30' of black, three conductor, flexible SEOW cord for power connection at pole-base hand hole. PMMA optics for superior illumination and glare control. OLC® One LED Concept. 0-10V Dimming comes standard with luminaire.

Recommended mounting height 10-20 ft, depending on wattage selected; mounting bracket required.

Specify product with 7 Digit product code - Finish Color. Accessories, such as mounting, optical, and electrical, must be specified separately.

Example: XXX-XXXX-9004 (Black)
+ XXX-XXXX (Accessory 1)

| | |
|--------------------|------------------------------|
| Weight | 22.00 lb |
| Light distribution | [R65] Type IV Medium |
| Light source | LED-12/24W / 700 mA - 3000 K |
| CRI | 80 |
| Power supply | electronic gear |
| BUG | B1 U0 G1 |
| LEDs | 12 |
| Rated input power | 27 W |

Nominal Lumen (lm)

| | |
|-------------|------|
| LED Lumen | 290 |
| Total Lumen | 3480 |
| Tj | 85 |

Rated lumens (lm)

| | |
|-------------|--------|
| LED Lumen | 202.9 |
| Total Lumen | 2434.4 |
| Ta | 25 |

WE-EF LIGHTING USA, LLC

410-D Keystone Drive, 15086 Warrendale, PA 15086 - Phone: +1 724 742 0030
customersupport.usa@we-ef.com - <https://we-ef.com/us>
Subject to technical changes and errors. - Generated on 11/23/2024

108-1622

PFL230 LED

we-ef

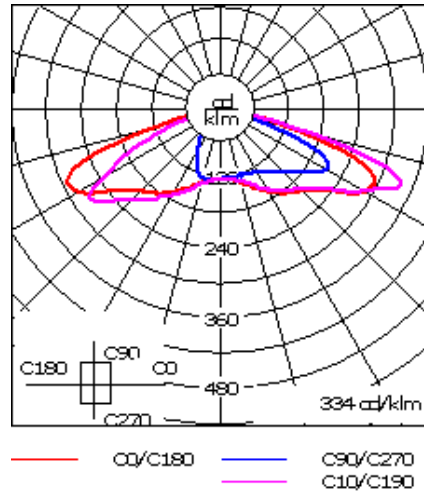
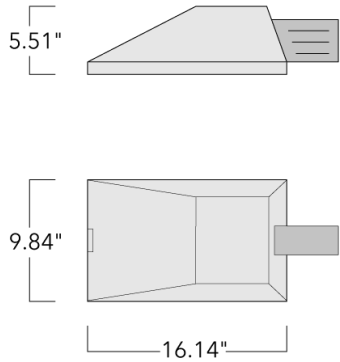

Specifications

Material description

| | |
|----------------------|---|
| Body | Marine-grade, die-cast aluminium alloy |
| Lens | Safety glass lens, hinged |
| Colors | <div style="display: flex; flex-direction: column; gap: 5px;"> <div> RAL9004 Black</div> <div> RAL9007 Grey Metallic</div> <div> RAL9016 White</div> <div> RAL8019 Dark Bronze</div> </div> |
| Gasket | Silicone CCG® Controlled Compression Gasket |
| Fasteners | PCS Polymer Coated Stainless Steel Hardware |
| Ingress protection | IP66 |
| Impact resistance | IK08 |
| Corrosion resistance | 5CE superior corrosion protection system |
| Windage | 0.45 ft ² |

WE-EF LIGHTING USA, LLC

410-D Keystone Drive, 15086 Warrendale, PA 15086 - Phone: +1 724 742 0030

customersupport.usa@we-ef.com - <https://we-ef.com/us>

Subject to technical changes and errors. - Generated on 11/23/2024

108-1622

PFL230 LED

we-ef

Electrical description

| | |
|------------------|---|
| Power supply | Integral [ECG] electronic driver 120V-277V. 0-10V dimmable, to be specified with order. |
| Driver / Ballast | Integral EC electronic converter |
| Power factor | > 0.9 |
| Surge protection | Integral 10kV Surge Protector |

Additional information

| | |
|------------|---|
| Lifetime | Ta=25°/40° L90B10 > 90000h |
| BUG Rating | Please see individual Spec Sheets for classification of Backlight, Uplight and Glare. |
| Listings | ETL, UL-1598, CSA-C22.2#250.0. Suitable for Wet Locations. |

WE-EF LIGHTING USA, LLC

410-D Keystone Drive, 15086 Warrendale, PA 15086 - Phone: +1 724 742 0030
customersupport.usa@we-ef.com - <https://we-ef.com/us>
Subject to technical changes and errors. - Generated on 11/23/2024

Mounting Accessories

Wall and pole brackets KI

| Description | Part ID | A | C1 | D1 | D2 | D × L1 | H1 | L | M1 | Weight (lb) | Alpha | C | D | H |
|----------------------|----------|------|------|------|------|--------|----|---|------|-------------|-------|-----|-----|-----|
| KI0-230 Wall bracket | 108-0430 | ±30° | 8.27 | 7.09 | 5.83 | | | | 0.26 | 6.61 | ± 3° | 210 | 180 | 180 |

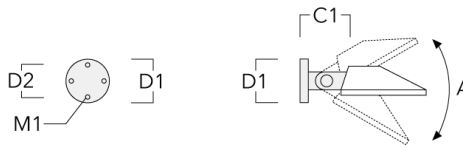

| | | | | | | | | | | | | | | |
|------------------------------|----------|------|------|--|--|-------|-------|------|--|------|------|-----|--|-----|
| KI1-230 Pole bracket, single | 108-0431 | ±30° | 8.27 | | | 3 x 3 | 18.70 | 2.99 | | 9.48 | ± 3° | 210 | | 475 |
|------------------------------|----------|------|------|--|--|-------|-------|------|--|------|------|-----|--|-----|

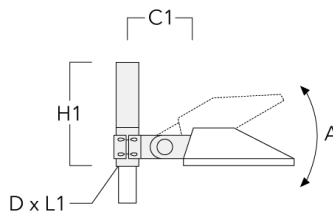

PFL230 LED

| Description | Part ID | A | C1 | D1 | D2 | D × L1 | H1 | L | M1 | Weight (lb) | Alpha | C | D | H |
|------------------------------|----------|------|------|----|----|--------|-------|------|----|-------------|-------|-----|---|-----|
| K12-230 Pole bracket, double | 108-0432 | ±30° | 8.27 | | | 3 x 3 | 18.70 | 2.99 | | 9.48 | ± 3° | 210 | | 475 |

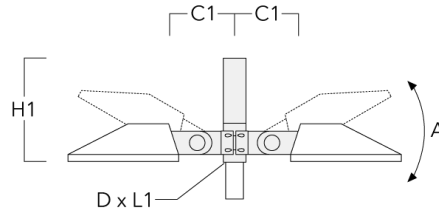

Wall and pole brackets KP

| Description | Part ID | C1 | D1 | D2 | D × L1 | H1 | L | M1 | Weight (lb) | C | D | H |
|----------------------|----------|------|------|------|--------|----|---|------|-------------|-----|-----|-----|
| KP0-230 Wall bracket | 108-0433 | 7.68 | 7.09 | 5.51 | | | | 0.47 | 3.31 | 175 | 180 | 180 |

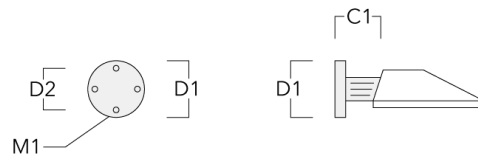

WE-EF LIGHTING USA, LLC

410-D Keystone Drive, 15086 Warrendale, PA 15086 - Phone: +1 724 742 0030

customersupport.usa@we-ef.com - <https://we-ef.com/us>

Subject to technical changes and errors. - Generated on 11/23/2024

PFL230 LED

| Description | Part ID | C1 | D1 | D2 | D × L1 | H1 | L | M1 | Weight (lb) | C | D | H |
|------------------------------|----------|------|----|----|--------|-------|------|----|-------------|-----|---|-----|
| KP1-230 Pole bracket, single | 108-0434 | 8.27 | | | 3 x 3 | 20.67 | 2.99 | | 7.94 | 175 | | 525 |

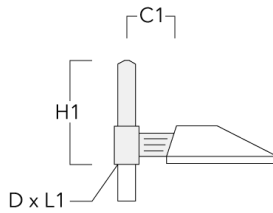

| | | | | | | | | | | | | |
|------------------------------|----------|------|--|--|-------|-------|------|--|------|-----|--|-----|
| KP2-230 Pole bracket, double | 108-0435 | 8.27 | | | 3 x 3 | 20.67 | 2.99 | | 9.48 | 175 | | 525 |
|------------------------------|----------|------|--|--|-------|-------|------|--|------|-----|--|-----|

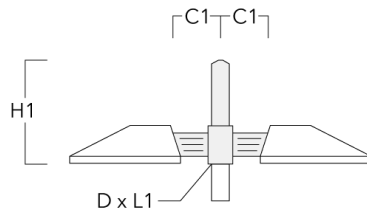

WE-EF LIGHTING USA, LLC

410-D Keystone Drive, 15086 Warrendale, PA 15086 - Phone: +1 724 742 0030

customersupport.usa@we-ef.com - <https://we-ef.com/us>

Subject to technical changes and errors. - Generated on 11/23/2024

Pole brackets KP_L

| Description | Part ID | C1 | D x L1 | H1 | L | Weight (lb) | C | H |
|--------------------------------|----------|-------|--------|-------|------|-------------|-----|-----|
| KP1-L-230 Pole bracket, single | 108-0713 | 17.72 | 3 x 5 | 20.67 | 2.99 | 13.89 | 175 | 525 |

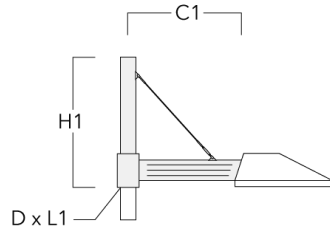

| | | | | | | | | |
|--------------------------------|----------|-------|-------|-------|------|-------|-----|-----|
| KP2-L-230 Pole bracket, double | 108-0714 | 17.72 | 3 x 5 | 20.67 | 2.99 | 20.94 | 175 | 525 |
|--------------------------------|----------|-------|-------|-------|------|-------|-----|-----|

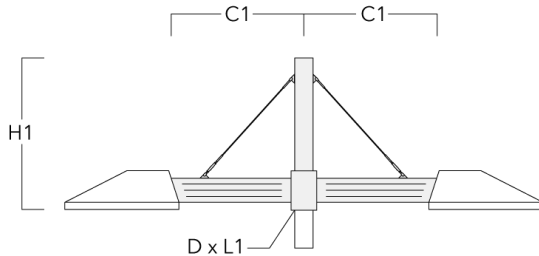

WE-EF LIGHTING USA, LLC

410-D Keystone Drive, 15086 Warrendale, PA 15086 - Phone: +1 724 742 0030
 customersupport.usa@we-ef.com - <https://we-ef.com/us>

Subject to technical changes and errors. - Generated on 11/23/2024

Pole brackets KY

| Description | Part ID | A | C1 | D x L1 | H1 | L | Weight(lb) | Alpha | C | H |
|------------------------------|----------|------|------|--------|-------|------|------------|-------|-----|-----|
| KY1-230 Pole bracket, single | 108-0496 | ±30° | 8.27 | 3 x 3 | 28.74 | 2.99 | 18.08 | ± 3° | 210 | 525 |

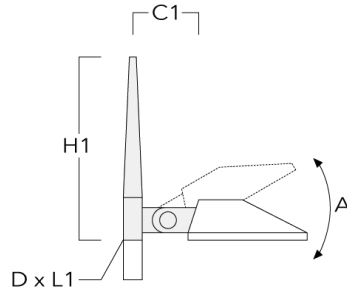

| | | | | | | | | | | |
|------------------------------|----------|------|------|-------|-------|------|-------|------|-----|-----|
| KY2-230 Pole bracket, double | 108-0497 | ±30° | 8.27 | 3 x 3 | 36.61 | 2.99 | 20.72 | ± 3° | 210 | 525 |
|------------------------------|----------|------|------|-------|-------|------|-------|------|-----|-----|

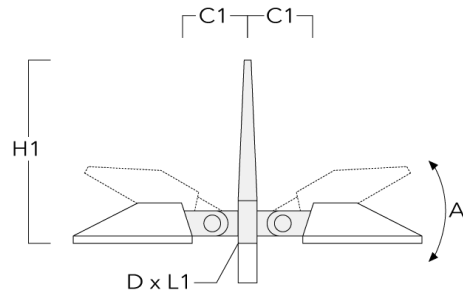

WE-EF LIGHTING USA, LLC

410-D Keystone Drive, 15086 Warrendale, PA 15086 - Phone: +1 724 742 0030
 customersupport.usa@we-ef.com - <https://we-ef.com/us>

Subject to technical changes and errors. - Generated on 11/23/2024

108-1622

PFL230 LED

we-ef

Pole clamp SI

| Description | Part ID | C1 | D1 | Weight (lb) | C |
|--|----------|------|----------|-------------|-----|
| SI1-230 Pole clamp, single (Ø 3"-3.5") | 108-0478 | 8.27 | 3.0-3.50 | 6.39 | 210 |

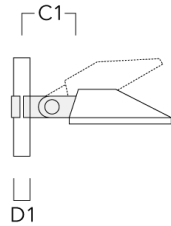

| | | | | | |
|--|----------|------|----------|------|-----|
| SI1-230 Pole clamp, single (Ø 4"-4.5") | 108-0479 | 8.27 | 4.0-4.50 | 6.83 | 210 |
|--|----------|------|----------|------|-----|

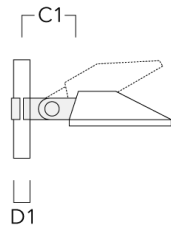

WE-EF LIGHTING USA, LLC

410-D Keystone Drive, 15086 Warrendale, PA 15086 - Phone: +1 724 742 0030

customersupport.usa@we-ef.com - <https://we-ef.com/us>

Subject to technical changes and errors. - Generated on 11/23/2024

PFL230 LED

| Description | Part ID | C1 | D1 | Weight (lb) | C |
|--|----------|------|----------|-------------|-----|
| SI2-230 Pole clamp, double (Ø 3"-3.5") | 108-0480 | 8.27 | 3.0-3.50 | 9.92 | 210 |

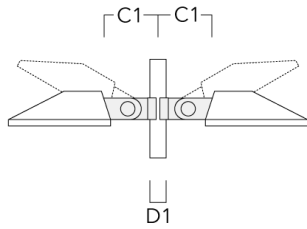

| | | | | | |
|--|----------|------|----------|-------|-----|
| SI2-230 Pole clamp, double (Ø 4"-4.5") | 108-0481 | 8.27 | 4.0-4.50 | 10.36 | 210 |
|--|----------|------|----------|-------|-----|

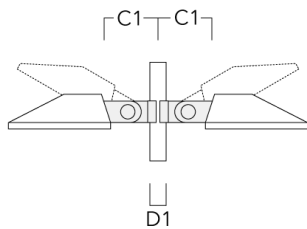

WE-EF LIGHTING USA, LLC

410-D Keystone Drive, 15086 Warrendale, PA 15086 - Phone: +1 724 742 0030
customersupport.usa@we-ef.com - <https://we-ef.com/us>
Subject to technical changes and errors. - Generated on 11/23/2024

108-1622

we-ef

PFL230 LED

Pole clamp SK

| Description | Part ID | C1 | D1 | Weight (lb) | C |
|--|----------|------|----------|-------------|-----|
| SK1-230 Pole clamp, single (Ø 3"-3.5") | 108-0474 | 6.89 | 3.0-3.50 | 4.63 | 175 |

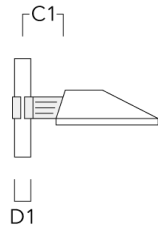

| | | | | | |
|--|----------|------|----------|------|-----|
| SK1-230 Pole clamp, single (Ø 4"-4.5") | 108-0475 | 6.89 | 4.0-4.50 | 5.29 | 175 |
|--|----------|------|----------|------|-----|

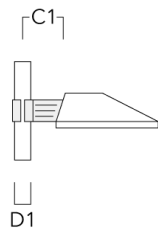

WE-EF LIGHTING USA, LLC

410-D Keystone Drive, 15086 Warrendale, PA 15086 - Phone: +1 724 742 0030
customersupport.usa@we-ef.com - <https://we-ef.com/us>
Subject to technical changes and errors. - Generated on 11/23/2024

108-1622

PFL230 LED

we-ef

| Description | Part ID | C1 | D1 | Weight (lb) | C |
|--|----------|------|----------|-------------|-----|
| SK2-230 Pole clamp, double (Ø 3"-3.5") | 108-0476 | 6.89 | 3.0-3.50 | 6.39 | 175 |

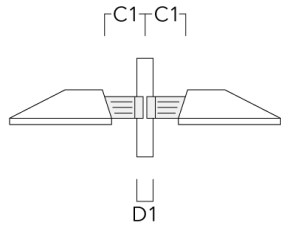

| | | | | | |
|--|----------|------|----------|------|-----|
| SK2-230 Pole clamp, double (Ø 4"-4.5") | 108-0477 | 6.89 | 4.0-4.50 | 7.05 | 175 |
|--|----------|------|----------|------|-----|

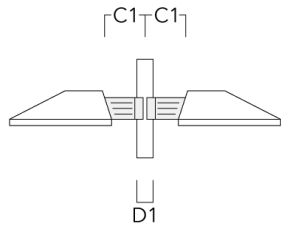

WE-EF LIGHTING USA, LLC

410-D Keystone Drive, 15086 Warrendale, PA 15086 - Phone: +1 724 742 0030
customersupport.usa@we-ef.com - <https://we-ef.com/us>

Subject to technical changes and errors. - Generated on 11/23/2024

108-1622

PFL230 LED

we-ef

Optical Accessories

Light shield

| Description | Part ID | Additional information |
|-------------|----------|---|
| LS180-[A60] | 430-0038 | Light shield LS180 to greatly reduce or eliminate light pollution. PA injection moulded component, black matt. Suitable for asymmetric light distribution [A60]. |
| LS180 | 430-0029 | Glare Shield for backlight spill. Glare Shield factory-installed or available as retrofit kit. Suitable for [S60], [S65], [S70], [R65], [P65] lenses. Must be specified at time of ordering. |

WE-EF LIGHTING USA, LLC

410-D Keystone Drive, 15086 Warrendale, PA 15086 - Phone: +1 724 742 0030
customersupport.usa@we-ef.com - <https://we-ef.com/us>

Subject to technical changes and errors. - Generated on 11/23/2024