



Description

IP66/IP67. IK09. Marine-grade, all-aluminium construction. 5CE superior corrosion protection including PCS hardware. PMMA lens. Silicone rubber gaskets. 1.2 m of flexible PVC-free cable. Luminaire is factory-sealed and does not need to be opened during installation.

Integral EC electronic converter in thermally-separated compartment. Advanced thermal management protects LEDs while optimising lumens output. Removable LED boards for upgrading. DALI interface.

Weight	2.45 kg
Light distribution	asymmetric linear, wallwash [LA10]
Light source	LED-32/20W / 225 mA - 4000 K
CRI	80
Power supply	EC
LEDs	32
Rated input power	23.5 W
Nominal Lumen (lm)	
LED Lumen	90
Total Lumen	2880
T _j	85
Rated lumens (lm)	
LED Lumen	64.1
Total Lumen	2049.8
T _a	25

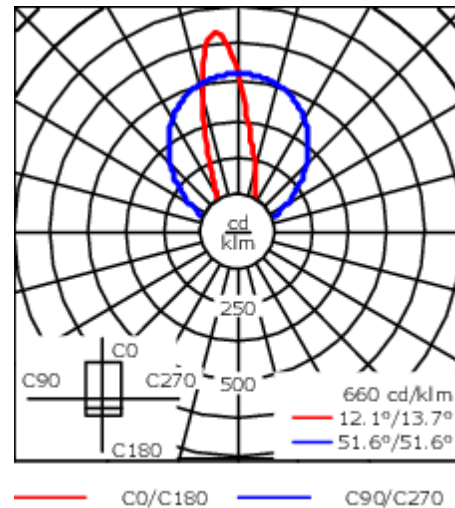
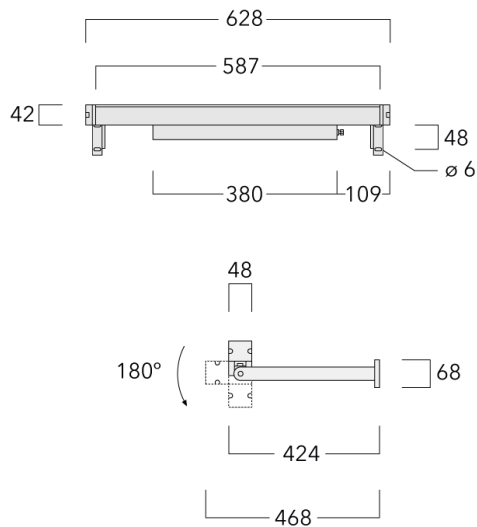

Specifications

Material description

Body	Marine-grade, all-aluminium construction
Lens	PMMA lens
Colours	<div style="display: flex; align-items: center;"> <div style="width: 20px; height: 10px; background-color: black; margin-right: 5px;"></div> RAL9004 Signal black </div> <div style="display: flex; align-items: center; margin-top: 5px;"> <div style="width: 20px; height: 10px; background-color: grey; margin-right: 5px;"></div> RAL9007 Grey aluminium </div> <div style="display: flex; align-items: center; margin-top: 5px;"> <div style="width: 20px; height: 10px; background-color: darkgrey; margin-right: 5px;"></div> RAL7016 Anthracite grey </div> <div style="display: flex; align-items: center; margin-top: 5px;"> <div style="width: 20px; height: 10px; background-color: white; margin-right: 5px;"></div> RAL9016 Traffic white </div>
Gasket	Silicone rubber gaskets
Fasteners	PCS hardware
Ingress protection	IP66/IP67
Impact resistance	IK09
Corrosion resistance	5CE

Electrical description

Power supply	220-240V / 50-60 Hz
Driver / Ballast	Integral electronic DALI converter in thermally-separated compartment

Additional information

Lifetime	Ta=25° L90B10 > 90000h
----------	------------------------