

187-0331

VLR140 [LA10]

**we-ef**



#### Description

IP67, Class I. IK09. Marine-grade, all aluminium construction. 5CE superior corrosion protection including PCS hardware. Silicone rubber gasket. PMMA. Linear PMMA LED lens. 1.2 m connecting cable, UV stabilized, PVC free. Luminaire is factory sealed and does not need to be opened during installation and can be tilted up to 180°. Integral LED driver with DALI interface.

Separate LED driver on request.

Weight	4.00 kg
Light distribution	asymmetric linear, wallwash [LA10]
Light source	LED-64/40W / 225 mA - 4000 K
CRI	80
Power supply	EC
LEDs	64
Rated input power	44 W
<b>Nominal Lumen (lm)</b>	
LED Lumen	90
Total Lumen	5760
T <sub>j</sub>	85
<b>Rated lumens (lm)</b>	
LED Lumen	64.1
Total Lumen	4099.7
T <sub>a</sub>	25

#### Fagerhult Lighting Ltd

33-34 Dolben Street, SE1 0UQ London, United Kingdom

<https://we-ef.com/uk>

Subject to technical changes and errors. - Generated on 23/10/2024

187-0331



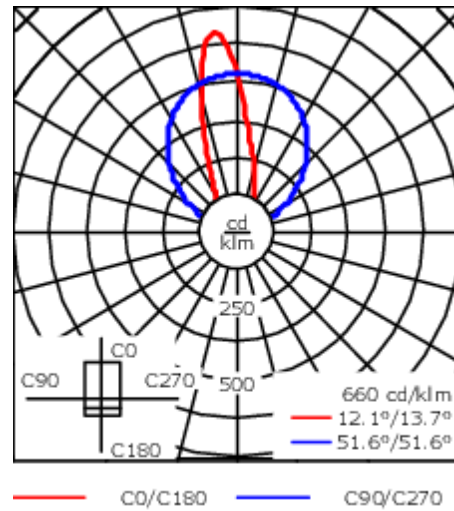
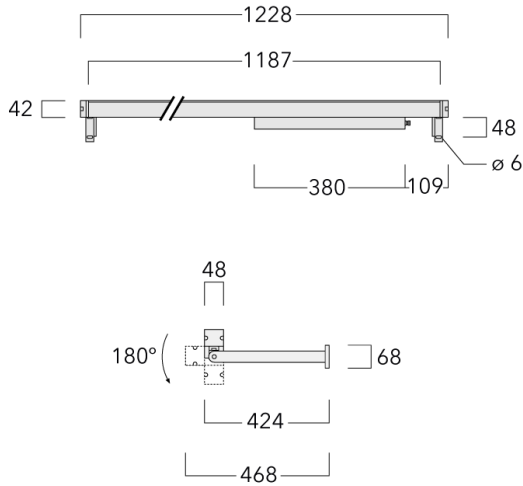

VLR140 [LA10]

we-ef



## Specifications

### Material description

Body	Marine-grade, all-aluminium construction
Lens	PMMA
Colours	 RAL9004 Signal black  RAL9006 White aluminium  RAL9007 Grey aluminium  RAL7016 Anthracite grey  RAL9016 Traffic white
Gasket	Silicone rubber gasket
Fasteners	PCS Polymer Coated Stainless Steel Hardware
Ingress protection	IP67
Impact resistance	IK09
Corrosion resistance	5CE

### Electrical description

Power supply	220-240V / 50-60 Hz
Driver / Ballast	Integral LED driver with DALI Interface

### Additional information

Lifetime	Ta=25° L90B10 > 90000h
Energy efficiency class	D (Light source)

#### Fagerhult Lighting Ltd

33-34 Dolben Street, SE1 0UQ London, United Kingdom

<https://we-ef.com/uk>

Subject to technical changes and errors. - Generated on 23/10/2024

**187-0331**

**VLR140 [LA10]**

**Fagerhult Lighting Ltd**

33-34 Dolben Street, SE1 0UQ London, United Kingdom

<https://we-ef.com/uk>

Subject to technical changes and errors.  
Generated on 23/10/2024