

185-3077

ESC130 LED

we-ef



Description

IP67. Class I. IK07. Stainless steel construction in-ground section. Marine-grade, die-cast aluminum alloy hood with 30° angle avoids glare to passers-by and helps prevent accumulation of insects, leaves and debris on the lens. 5CE superior corrosion protection including PCS hardware. Silicone CCG® Controlled Compression Gasket. Safety glass lens. Factory-sealed termination chamber complete with cable gland including spiral cable bending protection and 3 ft of flexible PVC-free cable. CAD-optimized optics for superior illumination and glare control. Integral driver in thermally separated compartment. Factory-installed LED circuit board. 0-10V Dimming comes standard with luminaire.

Suitable for flush installation in concrete or earth. The optional installation blockout is recommended for mounting; to be ordered separately.

Specify product with 7 Digit product code - Finish Color. Accessories, such as mounting, optical, and electrical, must be specified separately.

Example: XXX-XXXX-9004 (Black)
+ XXX-XXXX (Accessory 1)

Weight	18.00 lb
Light distribution	symmetric, medium beam [M]
Light source	LED-12/18W / 500 mA - 3000 K
CRI	80
Power supply	electronic gear
LEDs	12
Rated input power	21 W

Nominal Lumen (lm)

LED Lumen	215
Total Lumen	2580
Tj	85

Delivered lumens (lm)

LED Lumen	146.3
Total Lumen	1755.1
Ta	25

WE-EF LIGHTING USA, LLC

410-D Keystone Drive, 15086 Warrendale, PA 15086 - Phone: +1 724 742 0030
customersupport.usa@we-ef.com - <https://we-ef.com/us>
Subject to technical changes and errors. - Generated on 04/19/2025

185-3077



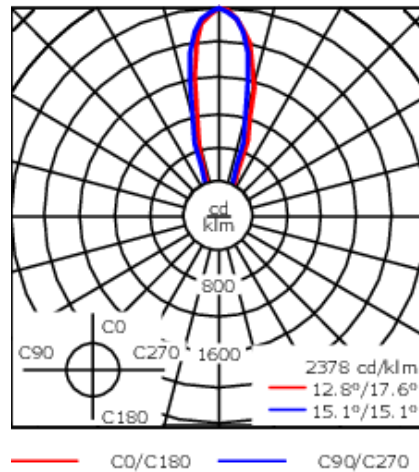
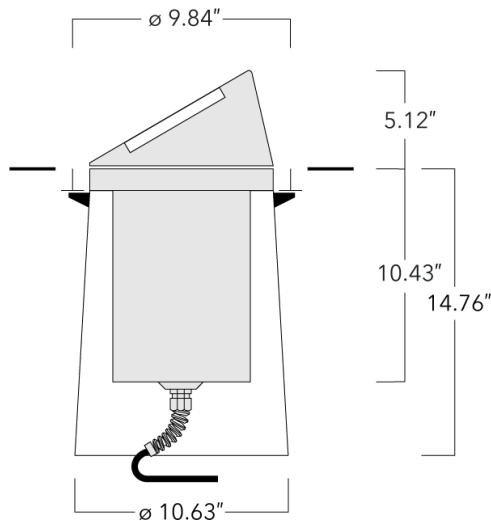

ESC130 LED

we-ef



Specifications

Material description

Body	Stainless steel body. Marine grade high pressure die cast aluminum frame
Lens	Safety glass lens
Colors	<ul style="list-style-type: none"> RAL9004 Black RAL9007 Grey Metallic RAL9016 White RAL8019 Dark Bronze
Gasket	Silicone rubber gasket
Fasteners	PCS Polymer Coated Stainless Steel Hardware
Ingress protection	IP67
Impact resistance	IK07
Corrosion resistance	5CE

Electrical description

Power supply	Integral [ECG] electronic driver 120V-277V. 0-10V dimmable, to be specified with order.
Driver / Ballast	Integral EC electronic converter
Power factor	> 0.9
Surge protection	6/6 kV

WE-EF LIGHTING USA, LLC

410-D Keystone Drive, 15086 Warrendale, PA 15086 - Phone: +1 724 742 0030

customersupport.usa@we-ef.com - <https://we-ef.com/us>

Subject to technical changes and errors. - Generated on 04/19/2025

185-3077

ESC130 LED

we-ef

Additional information

Lifetime	Ta=25°/40° L90B10 > 90000h
Dimming	0-10V available in request. Must be factory fitted.
Listings	Contact WE-EF USA for ETL/UL Certification Status

WE-EF LIGHTING USA, LLC

410-D Keystone Drive, 15086 Warrendale, PA 15086 - Phone: +1 724 742 0030
customersupport.usa@we-ef.com - <https://we-ef.com/us>
Subject to technical changes and errors. - Generated on 04/19/2025

185-3077

ESC130 LED

we-ef

Electrical Accessories

Sealable junction box

Description	Part ID	C1	M1	M2
Sealable junction box SJB 130	185-1624	5.75	Ø 0.39	Ø 0.47 - 0.75

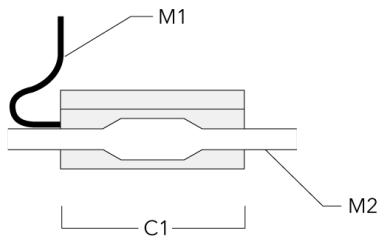

WE-EF LIGHTING USA, LLC

410-D Keystone Drive, 15086 Warrendale, PA 15086 - Phone: +1 724 742 0030
customersupport.usa@we-ef.com - <https://we-ef.com/us>

Subject to technical changes and errors. - Generated on 04/19/2025