



Description

IP67, Class I. IK07. Stainless steel construction inground section. Die-cast hood with 30° angle made from marine-grade aluminium alloy avoids glare to passers-by and helps prevent accumulation of insects, leaves and debris on the lens. 5CE superior corrosion protection including PCS hardware. Silicone rubber gasket. Safety glass lens. Integral EC electronic converter in thermally separated compartment. CAD-optimised optics for superior illumination and glare control. Factory installed LED circuit board. Factory-sealed termination chamber complete with cable gland including spiral cable bending protection and 1.5 m of flexible PVC free cable.

The optional installation blackout is recommended for mounting. To be ordered separately.

Weight	10.40 kg
Light distribution	symmetric, very narrow beam, sharp cut-off [EES]
Light source	LED-24/24W / 350 mA - 4000 K
CRI	80
Power supply	EC
LEDs	24
Rated input power	26.5 W
Nominal Lumen (lm)	
LED Lumen	170
Total Lumen	4080
Tj	85
Rated lumens (lm)	
LED Lumen	124.8
Total Lumen	2995.6
Ta	25

185-3087



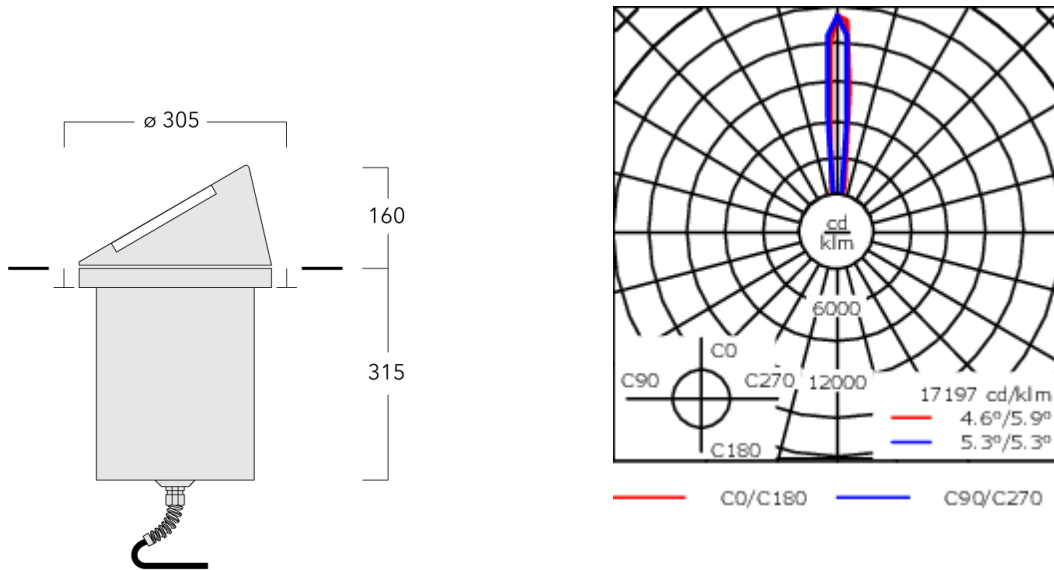

ESC140 LED

we-ef



Specifications

Material description

Body	Stainless steel inground section. Die-cast dome made from marine-grade aluminium alloy
Lens	Safety glass lens
Colours	 RAL9004 Signal black  RAL9006 White aluminium  RAL9007 Grey aluminium  RAL7016 Anthracite grey  RAL9016 Traffic white
Gasket	Silicone rubber gasket
Fasteners	PCS Polymer Coated Stainless Steel Hardware
Ingress protection	IP67
Impact resistance	IK07
Corrosion resistance	5CE

Electrical description

Power supply	220-240V / 50-60 Hz
Driver / Ballast	Integral EC electronic converter
Power factor	> 0.9
Surge protection	6/6 kV

Fagerhult Lighting Ltd

33-34 Dolben Street, SE1 0UQ London, United Kingdom

<https://we-ef.com/uk>

Subject to technical changes and errors. - Generated on 23/11/2024

185-3087

ESC140 LED

we-ef

Additional information

Lifetime Ta=25° L90B10 > 90000h

Energy efficiency class C-D (Light source)

Fagerhult Lighting Ltd

33-34 Dolben Street, SE1 0UQ London, United Kingdom

<https://we-ef.com/uk>

Subject to technical changes and errors. - Generated on 23/11/2024

185-3087

ESC140 LED

we-ef

Mounting Accessories

Installation blackout

Description	Part ID	D1	D2	H1	Weight (kg)	D	H
Blockout, Plastic	185-0323	300	325	420	2.50	300/325	420

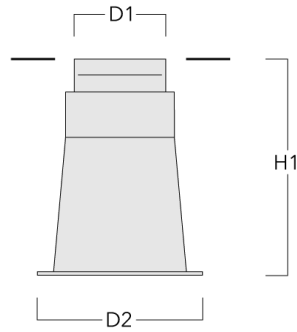

Installation cover

Description	Part ID	C1
Installation cover BE	185-0326	300

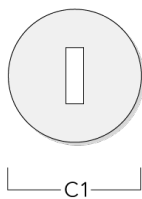

Fagerhult Lighting Ltd

33-34 Dolben Street, SE1 0UQ London, United Kingdom

<https://we-ef.com/uk>

Subject to technical changes and errors. - Generated on 23/11/2024

185-3087

ESC140 LED

we-ef

Electrical Accessories

Sealable junction box

Description	Part ID	C1	M1	M2
Sealable junction box SJB130	185-1624	146	Ø 10	Ø 12 - 19

