



Description

IP67*, Class I. IK10+. Stainless steel construction including PCS hardware. Silicone rubber gasket. Safety glass lens; max. load 5 tonnes. Luminaire can be driven over at low speed. Factory-sealed termination chamber complete with cable gland and 1.5 m of flexible PVC free cable. Cable gland with spiral cable bending protection. Integral EC electronic converter in thermally separated compartment. 'No tool' removable gear/lens tray. CAD-optimised optics for superior illumination and glare control. OLC® One LED Concept. Factory installed LED circuit board. Gimbal mounted, 360° rotatable and 30° tiltable.

The optional installation blackout is recommended for mounting. To be ordered separately.

Optional with Anti-Slip ceramic Coating ASC to DIN 51130 (Trip Classification 10) available on request.

The luminaire is not suitable for permanent underwater operation and must be switched off in the event of flooding.

* Additionally tested to IP66, IP67, IP68 0.1 bar 3h, up to 1 m depth according to DIN EN 60598 and IP69K/80° according to DIN EN 60529.

| | |
|--------------------|------------------------------|
| Weight | 6.20 kg |
| Light distribution | wallwash |
| Light source | LED-12/18W / 500 mA - 3000 K |
| CRI | 80 |
| Power supply | EC |
| LEDs | 12 |
| Rated input power | 21 W |

Nominal Lumen (lm)

| | |
|-------------|------|
| LED Lumen | 215 |
| Total Lumen | 2580 |
| Tj | 85 |

Rated lumens (lm)

| | |
|-------------|--------|
| LED Lumen | 150.2 |
| Total Lumen | 1802.7 |
| Ta | 25 |

Fagerhult Lighting Ltd

33-34 Dolben Street, SE1 0UQ London, United Kingdom

<https://we-ef.com/uk>

Subject to technical changes and errors. - Generated on 23/11/2024

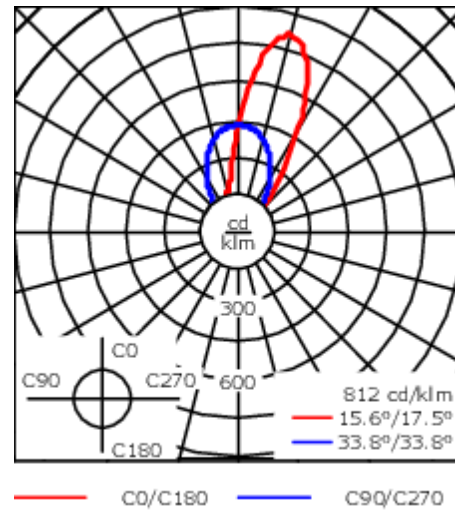
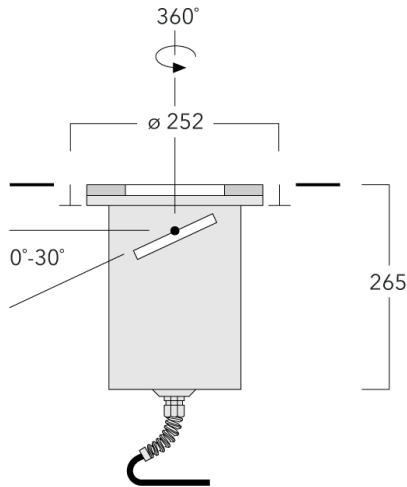

Specifications

Material description

| | |
|----------------------|---|
| Body | Stainless steel construction |
| Lens | Safety glass lens; max. load 5 tonnes |
| Colours |  Stainless Steel |
| Gasket | Silicone rubber gasket |
| Fasteners | PCS polymer coated stainless steel |
| Ingress protection | IP67 |
| Impact resistance | IK10+ |
| Corrosion resistance | 5CE |

Electrical description

| | |
|------------------|----------------------------------|
| Power supply | 220-240V / 50-60 Hz |
| Driver / Ballast | Integral EC electronic converter |
| Power factor | > 0.9 |
| Surge protection | 1/2 kV (optional SP10) |

Additional information

| | |
|-------------------------|------------------------|
| Lifetime | Ta=25° L90B10 > 90000h |
| Energy efficiency class | C-D (Light source) |

185-3091

ETC130-GB LED

we-ef

Mounting Accessories

Installation blackout

| Description | Part ID | D1 | D2 | H1 | Weight (kg) | D | H |
|-------------------|----------|-----|-----|-----|-------------|---------|-----|
| Blockout, Plastic | 185-0322 | 250 | 270 | 375 | 1.50 | 250/270 | 375 |

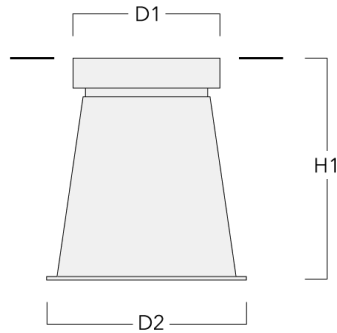

Installation cover

| Description | Part ID | C1 |
|-----------------------|----------|-----|
| Installation cover BE | 185-0325 | 250 |



Fagerhult Lighting Ltd

33-34 Dolben Street, SE1 0UQ London, United Kingdom

<https://we-ef.com/uk>

Subject to technical changes and errors. - Generated on 23/11/2024

185-3091

ETC130-GB LED

we-ef

Electrical Accessories

Sealable junction box

| Description | Part ID | C1 | M1 | M2 |
|------------------------------|----------|-----|------|-----------|
| Sealable junction box SJB130 | 185-1624 | 146 | Ø 10 | Ø 12 - 19 |



Optical Accessories

Linear spread lens

| Description | Part ID | Additional information | C1 |
|--------------------------|----------|------------------------|----|
| IO-180 ETC130/330-GB LED | 185-2632 | | 98 |

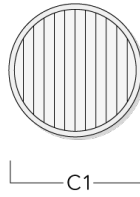

| | | | |
|-------------------|----------|---|-----|
| IO-180-DAC120-LED | 134-2000 | Broadens light distribution in one plane only. Ideally suitable for [M][EE][EES]. Does not fit in combination with [B] lens. A maximum of one internal optical accessory. Internal component, factory installed. | 130 |
|-------------------|----------|---|-----|

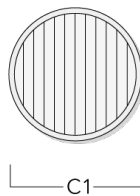

185-3091

ETC130-GB LED

we-ef

Flood lens

| Description | Part ID | C1 |
|----------------------|----------|----|
| IO-360-ETC130-GB-LED | 185-2866 | 98 |

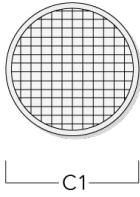

Honeycomb louvre

| Description | Part ID | C1 |
|---|----------|----|
| IW-ETC130/330-GB-LED - [M][EE] [EES] | 185-2870 | 98 |

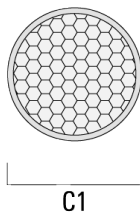

Fagerhult Lighting Ltd

33-34 Dolben Street, SE1 0UQ London, United Kingdom

<https://we-ef.com/uk>

Subject to technical changes and errors. - Generated on 23/11/2024