

## FLC141 LED

**Description**

IP66, Class I. Class II on request. IK07. Marine-grade, die-cast aluminium alloy. 5CE superior corrosion protection including PCS hardware. Silicone CCG® Controlled Compression Gasket. Safety glass lens. Integral EC electronic converter in thermally separated compartment. CAD-optimised optics for superior illumination and glare control. OLC® One LED Concept. Factory installed LED circuit board. The luminaire is factory- sealed and does not need to be opened during the installation.

Optional 2200 K version available. To be specified at time of ordering.

Weight	4.40 kg
Light distribution	wallwash
Light source	LED-24/48W / 700 mA - 4000 K
CRI	80
Power supply	EC
LEDs	24
Rated input power	54 W

**Nominal Lumen (lm)**

LED Lumen	310
Total Lumen	7440
Tj	85

**Rated lumens (lm)**

LED Lumen	216.1
Total Lumen	5186.6
Ta	25

**WE-EF LEUCHTEN GmbH**

Töpinger Straße 16, 29646 Bispingen, Germany - Phone: +49 5194 909-0  
info@we-ef.com - <https://we-ef.com>

Subject to technical changes and errors. - Generated on 23/11/2024

**FLC141 LED**

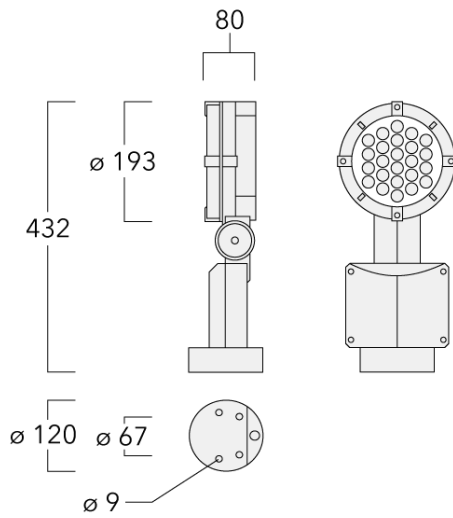

**Specifications**

**Material description**

Body	Marine-grade, die-cast aluminium alloy
Lens	Safety glass lens
Colours	<ul style="list-style-type: none"> <li><span style="display: inline-block; width: 20px; height: 10px; background-color: black; margin-right: 5px;"></span> RAL9004 Signal black</li> <li><span style="display: inline-block; width: 20px; height: 10px; background-color: #cccccc; margin-right: 5px;"></span> RAL9006 White aluminium</li> <li><span style="display: inline-block; width: 20px; height: 10px; background-color: #808080; margin-right: 5px;"></span> RAL9007 Grey aluminium</li> <li><span style="display: inline-block; width: 20px; height: 10px; background-color: #333333; margin-right: 5px;"></span> RAL7016 Anthracite grey</li> <li><span style="display: inline-block; width: 20px; height: 10px; background-color: #e0e0e0; margin-right: 5px;"></span> RAL9016 Traffic white</li> </ul>
Gasket	Silicone CCG® Controlled Compression Gasket
Fasteners	PCS Polymer Coated Stainless Steel Hardware
Ingress protection	IP66
Impact resistance	IK07
Corrosion resistance	5CE
Windage	0.057 m <sup>2</sup>

**WE-EF LEUCHTEN GmbH**

Töpinger Straße 16, 29646 Bispingen, Germany - Phone: +49 5194 909-0

info@we-ef.com - <https://we-ef.com>

Subject to technical changes and errors. - Generated on 23/11/2024

**FLC141 LED**

**Electrical description**

---

Power supply	220-240V / 50-60 Hz
Driver / Ballast	Integral EC electronic converter in thermally-separated compartment
Surge protection	1/2 kV

---

**Additional information**

---

Lifetime	Ta=25° L90B10 > 90000h
Energy efficiency class	C-D (Light source)

---

**Optical Accessories**

**Glare shield**

Description	Part ID	A	C1
Glare shield ES	146-0229	120	145



**Snoot**

Description	Part ID	A	C1
Snoot ET	146-0398	120	145



**FLC141 LED**

**Honeycomb louvre**

---

Description	Part ID	C1
IW-FLC141-LED - [EE][EES]	146-0626	145

---

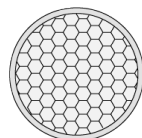

C1

**Mounting Accessories**

**Pipe clamp SP**

Description	Part ID	D1	Weight (kg)	D
SP1-2/M8 Pole clamp, single (Ø 76-89)	146-0246	76-89	1.20	76-89

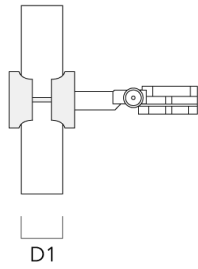

SP2-2/M8 Pole clamp, double (Ø 38-60)	146-0247	38-60	1	38-60
---------------------------------------	----------	-------	---	-------



**FLC141 LED**

Description	Part ID	D1	Weight (kg)	D
SP2-2/M8 Pole clamp, double (Ø 76-89)	146-0248	76-89	1.20	76-89



SP1-2/M8 Pole clamp, single (Ø 38-60)	146-0245	38-60	1	38-66
---------------------------------------	----------	-------	---	-------



**FLC141 LED**

**Short post EM**

Description	Part ID	D1	D2	H1	M1	Weight (kg)
EM1-2/M8	146-0253	160	130	200	9	1.10

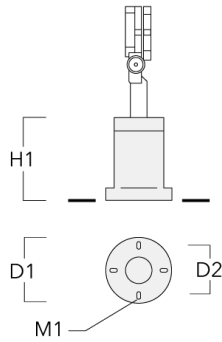

**Ground spike EF**

Description	Part ID	H1	Weight (kg)
Ground spike EF1-2/M8	146-0251	270	0.40

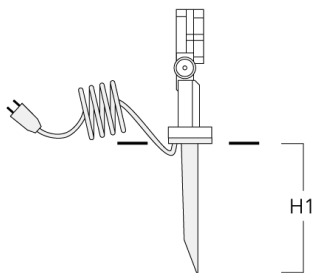



**FLC141 LED**

**Planted root**

Description	Part ID	D1	D2	D3	D4	H1	H2	M1	Weight(kg)
Planted root ESV4	300-0461	145	130	102	108	400	350	8	7.85

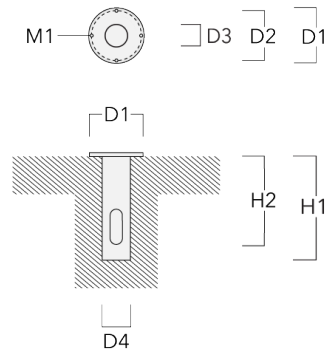

**Junction box JB1**

Description	Part ID	D1	D2	M1	Weight(kg)
JB1 Junction box	310-9000	135	67	9	1.6

