

## FLD111 LED RAIL66

**Description**

IP66, Class I. IK07. Marine-grade, die-cast aluminium alloy. 5CE superior corrosion protection + primer including PCS hardware. Silicone CCG® Controlled Compression Gasket. Safety glass lens. Integral EC electronic converter in thermally separated compartment. CAD-optimised optics for superior illumination and glare control. OLC® One LED Concept. Factory installed LED circuit board.

Including 0.4 m of flexible cable enclosed in stainless conduit, in-line connector and mounting clamp for installation to RAIL66 mounting system.

2700 K option available on request.

If ordering a fitting to be installed on an existing rail, please confirm the rail version with your local distributor or our customer excellence team as connectors vary.

|                    |                            |
|--------------------|----------------------------|
| Weight             | 2.40 kg                    |
| Light distribution | wallwash                   |
| Light source       | LED-3/6W / 700 mA - 3000 K |
| CRI                | 80                         |
| Power supply       | EC                         |
| LEDs               | 3                          |
| Rated input power  | 7.5 W                      |

**Nominal Lumen (lm)**

|             |     |
|-------------|-----|
| LED Lumen   | 290 |
| Total Lumen | 870 |
| Tj          | 85  |

**Rated lumens (lm)**

|             |       |
|-------------|-------|
| LED Lumen   | 152.7 |
| Total Lumen | 458.2 |
| Ta          | 25    |

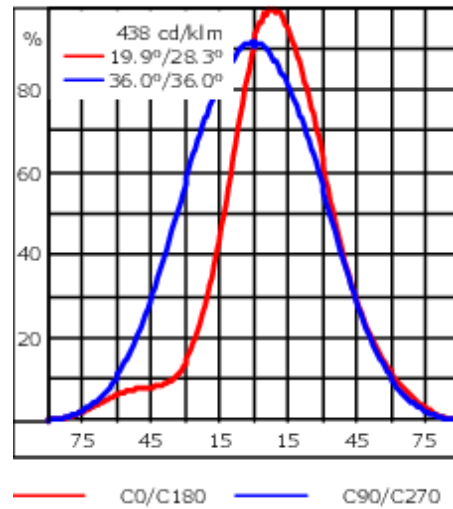
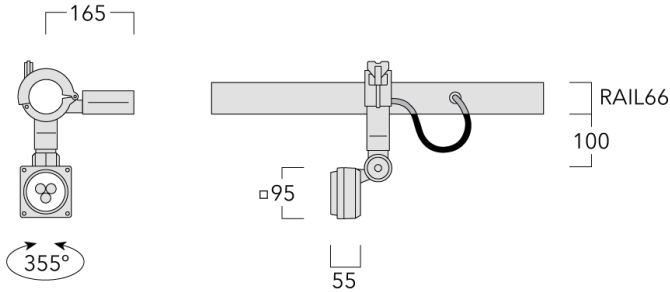

## Specifications

### Material description

|                      |  |
|----------------------|--|
| Body                 | Marine-grade, die-cast aluminium alloy   |
| Lens                 | Safety glass lens  |
| Colours              | <div style="display: flex; align-items: center;"> <div style="width: 20px; height: 15px; background-color: black; margin-right: 5px;"></div> <span>RAL9004 Signal black</span> </div> <div style="display: flex; align-items: center; margin-top: 5px;"> <div style="width: 20px; height: 15px; background-color: #cccccc; margin-right: 5px;"></div> <span>RAL9006 White aluminium</span> </div> <div style="display: flex; align-items: center; margin-top: 5px;"> <div style="width: 20px; height: 15px; background-color: #808080; margin-right: 5px;"></div> <span>RAL9007 Grey aluminium</span> </div> |
| Gasket               | Silicone CCG® Controlled Compression Gasket  |
| Fasteners            | PCS Polymer Coated Stainless Steel Hardware (unpainted)  |
| Ingress protection   | IP66   |
| Impact resistance    | IK07   |
| Corrosion resistance | 5CE+Primer   |

### Electrical description

|                  |   |
|------------------|---|
| Power supply     | 230V / 50 Hz  |
| Driver / Ballast | Integral EC electronic converter in thermally-separated compartment |

### Additional information

|          |  |
|----------|--|
| Lifetime | Ta=40° L90B10 > 90000h   |
| Warranty | The product is supplied with 10-year warranty. Please refer to the LED Warranty Statement located on <a href="http://www.we-ef.com">www.we-ef.com</a> for further details. |

### Optical Accessories

#### Optical Adaptor

---

| Description                 | Part ID  | A  | C1 |
|-----------------------------|----------|----|----|
| External optical adaptor EA | 145-9830 | 53 | 91 |

---

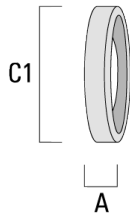

---

#### Snoot

---

| Description | Part ID  | A  | C1 |
|-------------|----------|----|----|
| Snoot ET    | 145-9832 | 53 | 91 |

---

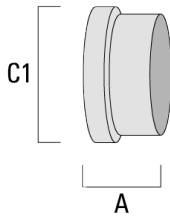

**FLD111 LED RAIL66**

**Linear spread lens**

---

| Description       | Part ID  | C1 |
|-------------------|----------|----|
| EO-180-FLD111-LED | 145-9833 | 68 |

---

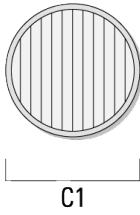

---

**Surface wash lens**

---

| Description       | Part ID  | C1 |
|-------------------|----------|----|
| EO-360-FLD111-LED | 145-9834 | 68 |

---

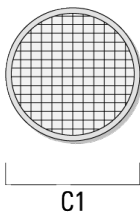

**Wallwash lens**

---

| Description         | Part ID  | C1 |
|---------------------|----------|----|
| Wallwash lens IO-20 | 145-9846 | 71 |

---



**Mounting Accessories**

**Universal**

| Description              | Part ID  | C1 | C2 | H1  | M1 | Weight (kg) | L1   | L2   |
|--------------------------|----------|----|----|-----|----|-------------|------|------|
| 2 Mains outlets (L=1150) | 310-9200 | 75 | 30 | 200 | 12 | 5.90        | 1150 | 1045 |

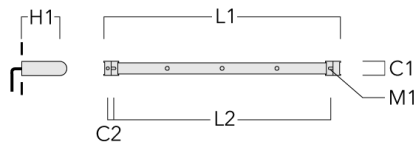

|                          |          |    |    |     |    |      |      |      |
|--------------------------|----------|----|----|-----|----|------|------|------|
| 3 Mains outlets (L=1150) | 310-9202 | 75 | 30 | 200 | 12 | 5.90 | 1150 | 1045 |
|--------------------------|----------|----|----|-----|----|------|------|------|

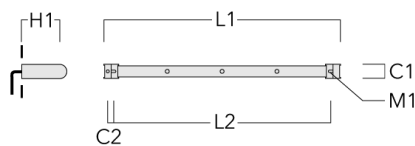

**FLD111 LED RAIL66**

| Description              | Part ID  | C1 | C2 | H1  | M1 | Weight (kg) | L1   | L2   |
|--------------------------|----------|----|----|-----|----|-------------|------|------|
| 3 Mains outlets (L=1650) | 310-9210 | 75 | 30 | 200 | 12 | 7.20        | 1650 | 1545 |



|                          |          |    |    |     |    |      |      |      |
|--------------------------|----------|----|----|-----|----|------|------|------|
| 4 Mains outlets (L=1650) | 310-9212 | 75 | 30 | 200 | 12 | 7.20 | 1650 | 1545 |
|--------------------------|----------|----|----|-----|----|------|------|------|



**FLD111 LED RAIL66**

| Description              | Part ID  | C1 | C2 | H1  | M1 | Weight (kg) | L1   | L2   |
|--------------------------|----------|----|----|-----|----|-------------|------|------|
| 4 Mains outlets (L=2150) | 310-9220 | 75 | 30 | 200 | 12 | 8.50        | 2150 | 2045 |



|                          |          |    |    |     |    |      |      |      |
|--------------------------|----------|----|----|-----|----|------|------|------|
| 6 Mains outlets (L=2150) | 310-9222 | 75 | 30 | 200 | 12 | 8.50 | 2150 | 2045 |
|--------------------------|----------|----|----|-----|----|------|------|------|





**FLD111 LED RAIL66**

**Flat Surface Fitters**

| Description            | Part ID  | C1 | C2 | D1  | D2  | L    | M1 | Weight (kg) |
|------------------------|----------|----|----|-----|-----|------|----|-------------|
| Surface fitters (pair) | 310-9290 | 20 | 30 | 180 | 140 | 1070 | 9  | 1.70        |



**Column Fitters**

| Description           | Part ID  | C1 | C2  | L    | M1 | Weight (kg) |
|-----------------------|----------|----|-----|------|----|-------------|
| Column fitters (pair) | 310-9294 | 30 | 100 | 1115 | 12 | 0.90        |

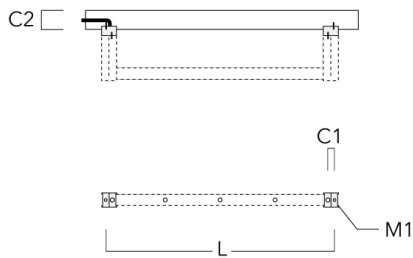

**FLD111 LED RAIL66**

**Cantilever**

| Description              | Part ID  | C1  | C2  | C3 | H1  | M1 | Weight (kg) | L1   | L2   |
|--------------------------|----------|-----|-----|----|-----|----|-------------|------|------|
| 2 Mains outlets (L=1150) | 310-9230 | 220 | 120 | 60 | 600 | 13 | 12          | 1150 | 1070 |

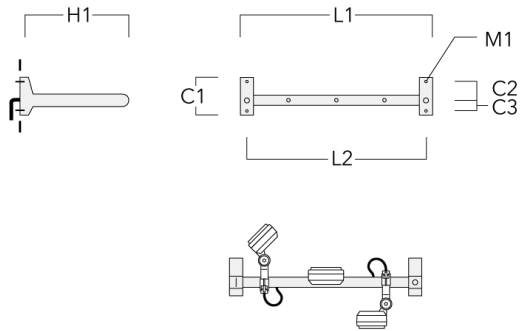

|                          |          |     |     |    |     |    |    |      |      |
|--------------------------|----------|-----|-----|----|-----|----|----|------|------|
| 3 Mains outlets (L=1150) | 310-9232 | 220 | 120 | 60 | 600 | 13 | 12 | 1150 | 1070 |
|--------------------------|----------|-----|-----|----|-----|----|----|------|------|

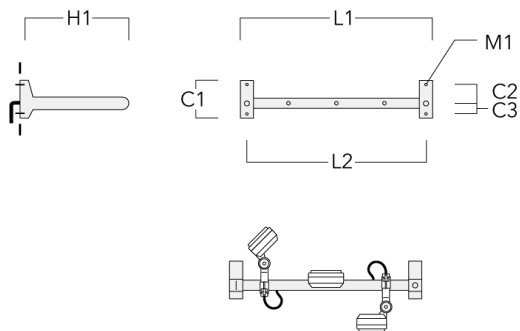

**FLD111 LED RAIL66**

| Description              | Part ID  | C1  | C2  | C3 | H1  | M1 | Weight (kg) | L1   | L2   |
|--------------------------|----------|-----|-----|----|-----|----|-------------|------|------|
| 3 Mains outlets (L=1650) | 310-9240 | 220 | 120 | 60 | 600 | 13 | 13.30       | 1650 | 1570 |

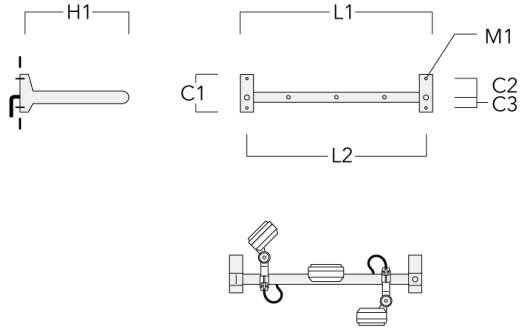

|                          |          |     |     |    |     |    |       |      |      |
|--------------------------|----------|-----|-----|----|-----|----|-------|------|------|
| 4 Mains outlets (L=1650) | 310-9242 | 220 | 120 | 60 | 600 | 13 | 13.30 | 1650 | 1570 |
|--------------------------|----------|-----|-----|----|-----|----|-------|------|------|

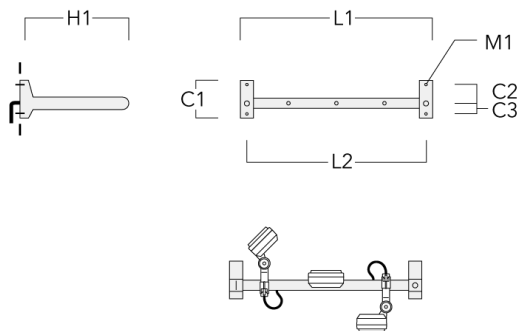

**FLD111 LED RAIL66**

| Description              | Part ID  | C1  | C2  | C3 | H1  | M1 | Weight (kg) | L1   | L2   |
|--------------------------|----------|-----|-----|----|-----|----|-------------|------|------|
| 4 Mains outlets (L=2150) | 310-9250 | 220 | 120 | 60 | 600 | 13 | 14.60       | 2150 | 2070 |

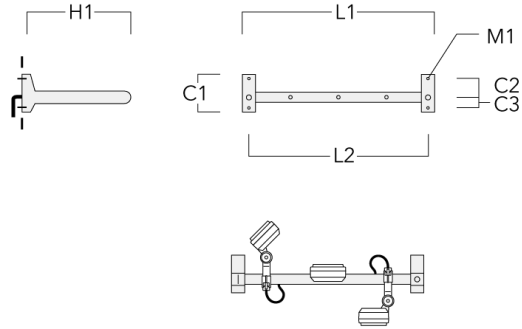

|                          |          |     |     |    |     |    |       |      |      |
|--------------------------|----------|-----|-----|----|-----|----|-------|------|------|
| 6 Mains outlets (L=2150) | 310-9252 | 220 | 120 | 60 | 600 | 13 | 14.60 | 2150 | 2070 |
|--------------------------|----------|-----|-----|----|-----|----|-------|------|------|

