



Description

IP55, Class I. IK08. Marine-grade, die-cast aluminium alloy. 5CE superior corrosion protection including PCS hardware. Silicone rubber gasket. Safety glass lens. Two cable entries.

A pre-installation blockout is available and recommended for mounting in concrete walls

Weight	3.40 kg
Light distribution	asymmetric, forward throw [A60]
Light source	LED-12W / 350 mA - 4000 K
CRI	80
Power supply	EC
LEDs	36
Rated input power	15 W

Nominal Lumen (lm)

LED Lumen	61.7
Total Lumen	2220
Tj	85

Rated lumens (lm)

LED Lumen	14.8
Total Lumen	531
Ta	25

197-9086



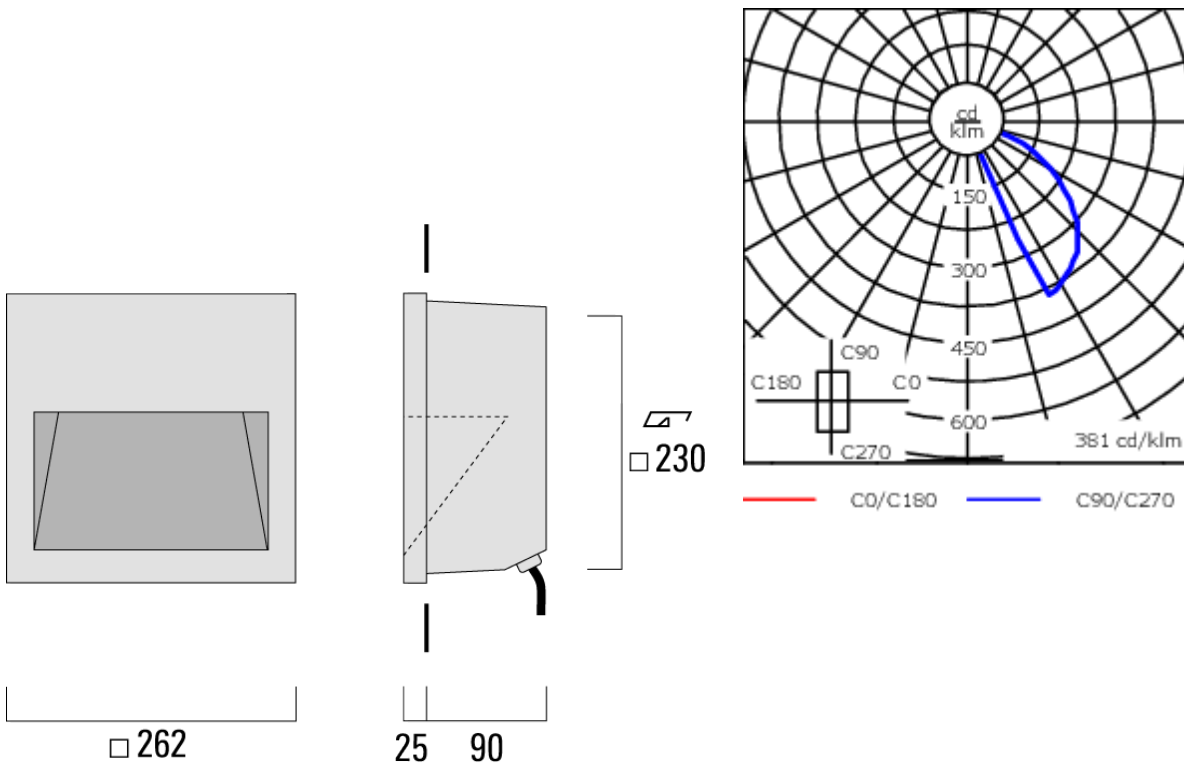

QRI354 LED

we-ef



Specifications

Material description

Body	Marine-grade, die-cast aluminium alloy
Lens	Safety glass lens
Colours	 RAL9004 Signal black  RAL9006 White aluminium  RAL9007 Grey aluminium  RAL7016 Anthracite grey  RAL9016 Traffic white
Gasket	Silicone rubber gasket
Fasteners	PCS hardware
Ingress protection	IP55
Impact resistance	IK08
Corrosion resistance	5CE

WE-EF LEUCHTEN GmbH

Töpinger Straße 16, 29646 Bispingen, Germany - Phone: +49 5194 909-0
info@we-ef.com - <https://we-ef.com>

Subject to technical changes and errors. - Generated on 23/11/2024

197-9086

QRI354 LED

we-ef

Electrical description

Power supply	Joint silicone
Driver / Ballast	Integral EC electronic converter
Surge protection	1/2 kV

Additional information

Lifetime	LED >60,000 h Ta 25°(B10/70) Control gear >50,000 h Ta 25°
----------	--

WE-EF LEUCHTEN GmbH

Töpinger Straße 16, 29646 Bispingen, Germany - Phone: +49 5194 909-0
info@we-ef.com - <https://we-ef.com>

Subject to technical changes and errors. - Generated on 23/11/2024

Mounting Accessories

Installation blackout

Description	Part ID	A	B	C1	C
Installation blackout BQR35-I	197-0129	272	272	125	125

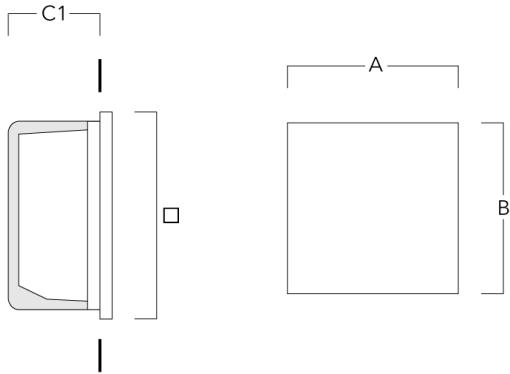

Installation blackout BQR35-II	197-0132	272	272	150	150
--------------------------------	----------	-----	-----	-----	-----

