



### Description

IP66. Class I. IK07. Marine-grade, die-cast aluminum alloy. 5CE superior corrosion protection including PCS hardware. Safety glass lens. Silicone CCG® Controlled Compression Gasket.

Integral EC electronic converter in thermally-separated compartment. Advanced thermal management protects LEDs while optimising lumens output. CAD-optimised optics for superior illumination and glare control. OLC® One LED Concept.

For 2200 K version available on request, except [EES] distribution.

|                    |                              |
|--------------------|------------------------------|
| Weight             | 7.60 kg                      |
| Light distribution | symmetric, medium beam [M]   |
| Light source       | LED-12/24W / 700 mA - 3000 K |
| CRI                | 80                           |
| Power supply       | EC                           |
| LEDs               | 12                           |
| Rated input power  | 27 W                         |

### Nominal Lumen (lm)

|             |      |
|-------------|------|
| LED Lumen   | 290  |
| Total Lumen | 3480 |
| Tj          | 85   |

### Rated lumens (lm)

|             |        |
|-------------|--------|
| LED Lumen   | 262.7  |
| Total Lumen | 3152.3 |
| Ta          | 25     |

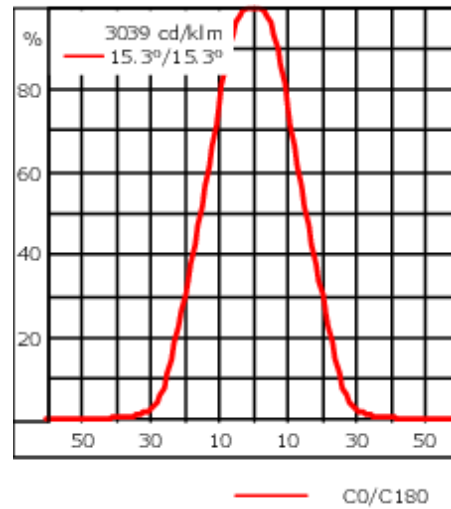
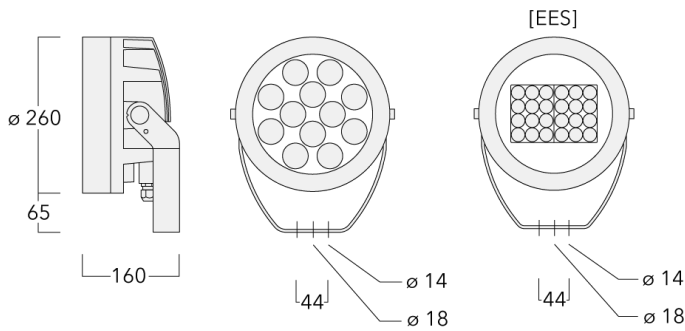

## Specifications

### Material description

|                      |  |
|----------------------|--|
| Body                 | Marine-grade, die-cast aluminium alloy   |
| Lens                 | Safety glass lens  |
| Colours              | <div style="display: flex; align-items: center;"> <div style="width: 20px; height: 15px; background-color: black; margin-right: 5px;"></div> <span>RAL9004 Signal black</span> </div> <div style="display: flex; align-items: center; margin-top: 5px;"> <div style="width: 20px; height: 15px; background-color: #808080; margin-right: 5px;"></div> <span>RAL9007 Grey aluminium</span> </div> <div style="display: flex; align-items: center; margin-top: 5px;"> <div style="width: 20px; height: 15px; background-color: #404040; margin-right: 5px;"></div> <span>RAL7016 Anthracite grey</span> </div> <div style="display: flex; align-items: center; margin-top: 5px;"> <div style="width: 20px; height: 15px; background-color: #e0e0e0; margin-right: 5px;"></div> <span>RAL9016 Traffic white</span> </div> |
| Gasket               | Silicone CCG® Controlled Compression Gasket  |
| Fasteners            | PCS Polymer Coated Stainless Steel Hardware  |
| Ingress protection   | IP66   |
| Impact resistance    | IK07   |
| Corrosion resistance | 5CE  |
| Windage              | 0.054 m <sup>2</sup>   |

### Electrical description

|                  |   |
|------------------|---|
| Power supply     | 220-240V / 50-60 Hz   |
| Driver / Ballast | Integral EC electronic converter in thermally-separated compartment |
| Power factor     | > 0.9   |

### Additional information

|          |                                     |
|----------|-------------------------------------|
| Lifetime | T <sub>a</sub> =25° L90B10 > 90000h |
|----------|-------------------------------------|

**Mounting Accessories**

**Short post**

| Description        | Part ID  | D1  | D2  | H1  | M1 | Weight (kg) |
|--------------------|----------|-----|-----|-----|----|-------------|
| Short post EM1-M16 | 270-9038 | 160 | 130 | 203 | 9  | 2.10        |



**Floodlight mounting bracket TA**

| Description                                | Part ID  | A | C1  | D x L1    | Weight (kg) | D x S     |
|--|----------|---|-----|-----------|-------------|-----------|
| TA1 Mounting bracket, single (Ø 108 x 200) | 147-0096 |   | 130 | 108 x 200 | 7.50        | 108 x 200 |



| Description                                | Part ID  | A | C1  | D × L1    | Weight (kg) | D × S     |
|--|----------|---|-----|-----------|-------------|-----------|
| TA2 Mounting bracket, double (Ø 108 x 200) | 147-0097 |   | 130 | 108 x 200 | 7.50        | 108 x 200 |

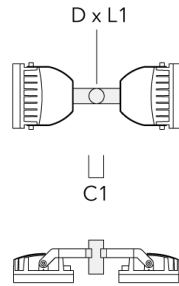

|  |          |      |     |           |       |           |
|--|----------|------|-----|-----------|-------|-----------|
| TA2-L Mounting bracket, double (Ø 108 x 200) | 147-0148 | ±90° | 420 | 108 x 200 | 20.20 | 108 x 200 |
|--|----------|------|-----|-----------|-------|-----------|

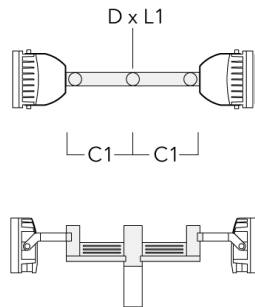

| Description                                 | Part ID  | A    | C1  | D x L1   | Weight (kg) | D x S    |
|---|----------|------|-----|----------|-------------|----------|
| TA2-L Mounting bracket, double (Ø 76 x 200) | 147-0105 | ±90° | 420 | 76 x 200 | 16.10       | 76 x 200 |

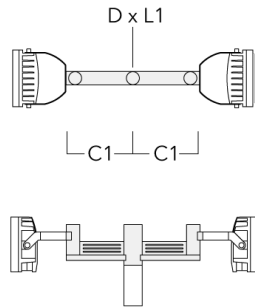

|   |          |      |     |          |       |          |
|---|----------|------|-----|----------|-------|----------|
| TA3 Mounting bracket, triple (Ø 89 x 200) | 147-0025 | ±90° | 650 | 89 x 200 | 17.90 | 89 x 200 |
|---|----------|------|-----|----------|-------|----------|

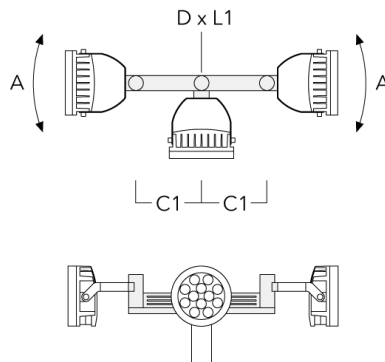

**FLC230 LED**

| Description                                | Part ID  | A    | C1  | D x L1    | Weight (kg) | D x S     |
|--|----------|------|-----|-----------|-------------|-----------|
| TA3 Mounting bracket, triple (Ø 108 x 200) | 147-0098 | ±90° | 650 | 108 x 200 | 24.20       | 108 x 200 |



|   |          |      |     |          |       |          |
|---|----------|------|-----|----------|-------|----------|
| TA4 Mounting bracket, quad (Ø 89 x 200) | 147-0099 | ±90° | 650 | 89 x 200 | 20.80 | 89 x 200 |
|---|----------|------|-----|----------|-------|----------|

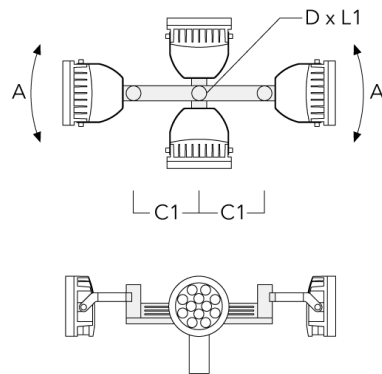

**FLC230 LED**

| Description                              | Part ID  | A    | C1  | D × L1    | Weight (kg) | D × S     |
|--|----------|------|-----|-----------|-------------|-----------|
| TA4 Mounting bracket, quad (Ø 108 x 200) | 147-0100 | ±90° | 650 | 108 x 200 | 24.20       | 108 x 200 |



**Planted root**

| Description       | Part ID     | D1  | D2  | D3 | D4 | H1  | H2  | M1 | T1  | T2       | Weight (kg) |
|-------------------|-------------|-----|-----|----|----|-----|-----|----|-----|----------|-------------|
| Planted root ESV4 | 300-0461-AP | 150 | 130 | 60 | 89 | 400 | 350 | 8  | 200 | 50 x 100 | 3.85        |

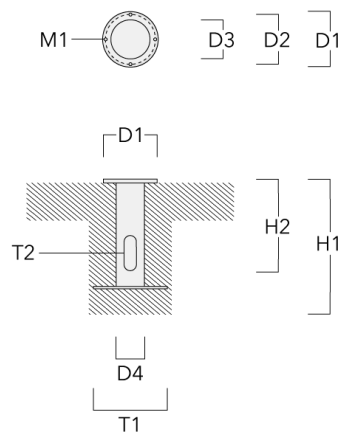

139-1830

FLC230 LED

**we-ef**

### Pole clamp

| Description                              | Part ID  | D1      | Weight (kg) | D       |
|--|----------|---------|-------------|---------|
| TS2-2/M12 Pole clamp, double (Ø 102-114) | 147-0527 | 102-114 | 1.50        | 102-114 |

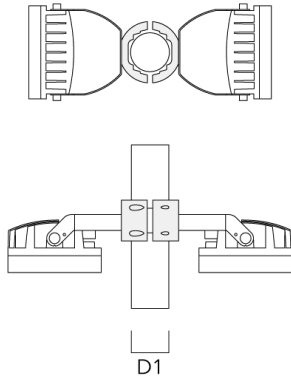

### Spigot cap

| Description                     | Part ID  | D1       | Weight (kg) |
|---------------------------------|----------|----------|-------------|
| Spigot Cap KF1-M16 (ø 60 x 100) | 310-9120 | 60 x 100 | 1.40        |

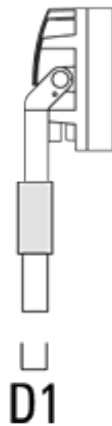

**WE-EF LIGHTING (Thailand) Co., Ltd.**

57 Moo 5, Kingkaew Rd., Bangplee, 10540 Samutprakarn - Phone: +66 2 738 96 20 - Fax: +66 2 738 96 29

<https://we-ef.com/asia>

Subject to technical changes and errors. - Generated on 23/11/2024



139-1830

FLC230 LED

**we-ef**

---

| Description                     | Part ID  | D1       | Weight (kg) |
|---------------------------------|----------|----------|-------------|
| Spigot Cap KF1-M16 (ø 76 x 100) | 310-9121 | 76 x 100 | 2.2         |

---

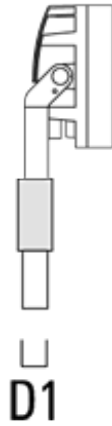

---

### Pole clamp SP - Tiltable

---

| Description                          | Part ID  | D1    | Weight (kg) | D     |
|--------------------------------------|----------|-------|-------------|-------|
| Pole clamp SP1-M16, single (Ø 76-89) | 146-0242 | 76-89 | 1.30        | 76-89 |

---

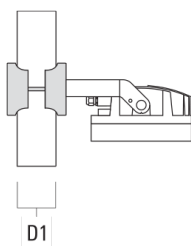

**WE-EF LIGHTING (Thailand) Co., Ltd.**

57 Moo 5, Kingkaew Rd., Bangplee, 10540 Samutprakarn - Phone: +66 2 738 96 20 - Fax: +66 2 738 96 29

<https://we-ef.com/asia>

Subject to technical changes and errors. - Generated on 23/11/2024

139-1830

FLC230 LED

**we-ef**

---

| Description                          | Part ID  | D1    | Weight (kg) | D |
|--------------------------------------|----------|-------|-------------|---|
| Pole clamp SP2-M16, double (Ø 76-89) | 146-0244 | 76-89 | 1.50        |   |

---

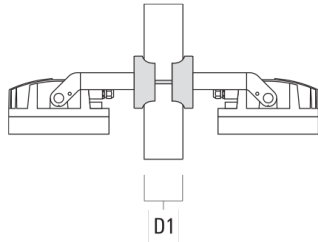

---

|                                      |          |       |      |  |
|--------------------------------------|----------|-------|------|--|
| Pole clamp SP1-M16, single (Ø 38-60) | 146-0241 | 38-60 | 1.30 |  |
|--------------------------------------|----------|-------|------|--|

---

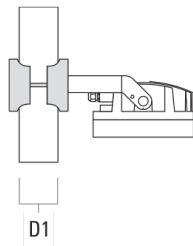

---

|                                      |          |       |      |  |
|--------------------------------------|----------|-------|------|--|
| Pole clamp SP2-M16, double (Ø 38-60) | 146-0243 | 38-60 | 1.50 |  |
|--------------------------------------|----------|-------|------|--|

---

**WE-EF LIGHTING (Thailand) Co., Ltd.**

57 Moo 5, Kingkaew Rd., Bangplee, 10540 Samutprakarn - Phone: +66 2 738 96 20 - Fax: +66 2 738 96 29

<https://we-ef.com/asia>

Subject to technical changes and errors. - Generated on 23/11/2024

**Junction box**

| Description                            | Part ID  | Additional information   | A   | B   | C1 | Weight (kg) |
|--|----------|--|-----|-----|----|-------------|
| Junction box JB20 - Cable side entries | 310-9013 | Junction boxes are made from marine-grade, die-cast aluminium alloy. IK10. IP66. For side entries and suitable to be used with cable glands. | 180 | 143 | 51 | 1.02        |

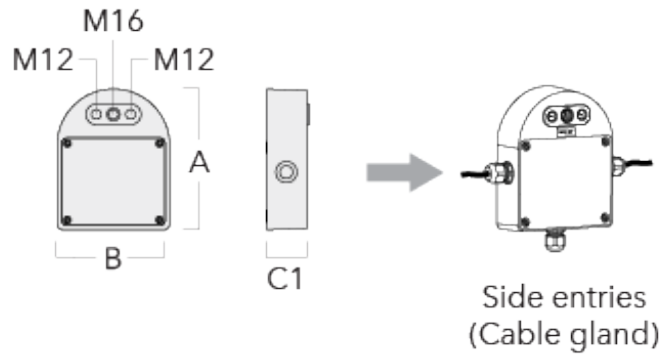

|  |          |  |     |     |    |      |
|--|----------|--|-----|-----|----|------|
| Junction box JB20 - Conduit side entries | 310-9014 | Junction boxes are made from marine-grade, die-cast aluminium alloy. IK10. IP66. For side entries and suitable to be used with conduits. | 180 | 143 | 51 | 1.02 |
|--|----------|--|-----|-----|----|------|

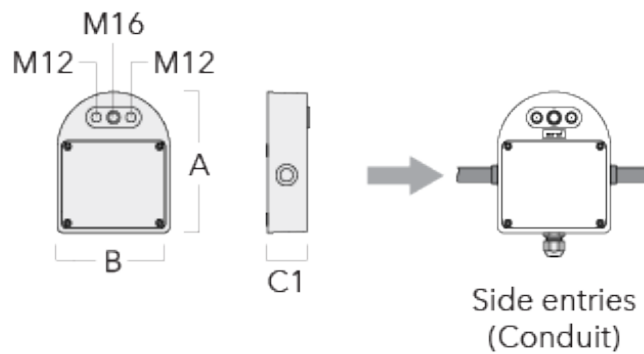

| Description                      | Part ID  | Additional information   | A   | B   | C1 | Weight (kg) |
|----------------------------------|----------|--|-----|-----|----|-------------|
| Junction box JB20 - Wall entries | 310-9018 | Junction boxes are made from marine-grade, die-cast aluminium alloy. IK10. IP66. For wall entries. | 180 | 143 | 51 | 1.02        |

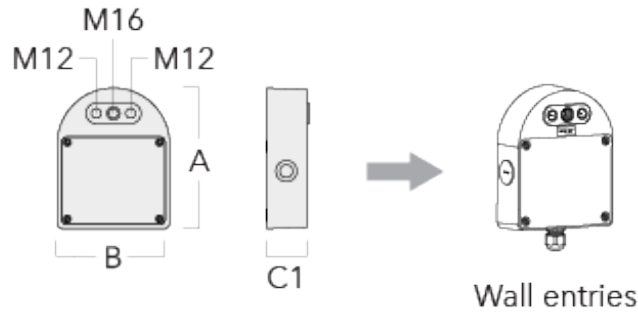

**Pole clamp PC - Rotatable**

| Description                               | Part ID  | D1    | Weight (kg) |
|---|----------|-------|-------------|
| PC2 76-89/60 Pole clamp, double (Ø 76-89) | 139-2703 | 76-89 | 1.00        |

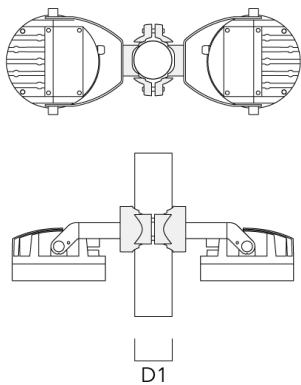

**FLC230 LED**

| Description                               | Part ID  | D1    | Weight (kg) |
|---|----------|-------|-------------|
| PC1 76-89/60 Pole clamp, single (Ø 76-89) | 139-2702 | 76-89 | 1.00        |



|   |          |         |      |
|---|----------|---------|------|
| PC2 102-114/60 Pole clamp, double (Ø 102-114) | 139-2707 | 102-114 | 1.20 |
|---|----------|---------|------|



**FLC230 LED**

| Description                                      | Part ID  | D1      | Weight (kg) |
|--|----------|---------|-------------|
| PC1 102-114/60 Pole clamp, single<br>(Ø 102-114) | 139-2706 | 102-114 | 1.20        |



|  |          |         |      |
|--|----------|---------|------|
| PC2 114-133/60 Pole clamp, double<br>(Ø 114-133) | 139-2709 | 114-133 | 1.40 |
|--|----------|---------|------|

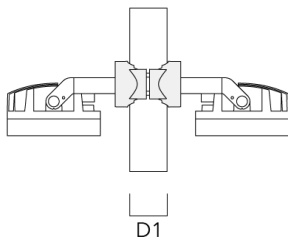

| Description                                      | Part ID  | D1      | Weight (kg) |
|--|----------|---------|-------------|
| PC1 114-133/60 Pole clamp, single<br>(Ø 114-133) | 139-2708 | 114-133 | 1.40        |



|  |          |        |      |
|--|----------|--------|------|
| PC2 82-109/60 Pole camp, double (Ø 82-109) | 139-2705 | 82-109 | 1.10 |
|--|----------|--------|------|

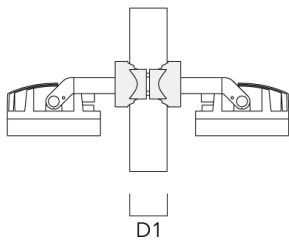
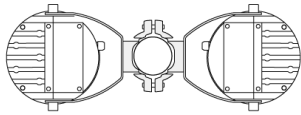

**139-1830**

**FLC230 LED**

**we-ef**

---

| Description                                | Part ID  | D1     | Weight (kg) |
|--|----------|--------|-------------|
| PC1 82-109/60 Pole camp, single (Ø 82-109) | 139-2704 | 82-109 | 1.10        |

---

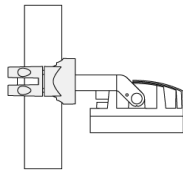
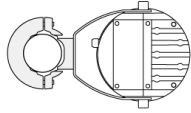

D1

**WE-EF LIGHTING (Thailand) Co., Ltd.**

57 Moo 5, Kingkaew Rd., Bangplee, 10540 Samutprakarn - Phone: +66 2 738 96 20 - Fax: +66 2 738 96 29

<https://we-ef.com/asia>

Subject to technical changes and errors. - Generated on 23/11/2024



**139-1830**

**FLC230 LED**

**we-ef**

## **Control**

### **1-10 V analogue dimming interface**

| Description                       | Part ID  | C  |
|-----------------------------------|----------|----|
| 1-10 V analogue dimming interface | 430-0011 | 90 |

## **R2C Ready to Connect**

| Description                | Part ID  |
|----------------------------|----------|
| R2C Ready to Connect (top) | 430-0019 |

**WE-EF LIGHTING (Thailand) Co., Ltd.**

57 Moo 5, Kingkaew Rd., Bangplee, 10540 Samutprakarn - Phone: +66 2 738 96 20 - Fax: +66 2 738 96 29

<https://we-ef.com/asia>

Subject to technical changes and errors. - Generated on 23/11/2024

139-1830

FLC230 LED

**we-ef**

## Optical Accessories

### Linear spread lens

| Description               | Part ID  | C1  |
|---------------------------|----------|-----|
| Linear spread lens IO-180 | 139-1849 | 199 |

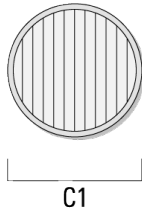

### Flood lens

| Description       | Part ID  | C1  |
|-------------------|----------|-----|
| Flood lens IO-360 | 139-1850 | 199 |



**WE-EF LIGHTING (Thailand) Co., Ltd.**

57 Moo 5, Kingkaew Rd., Bangplee, 10540 Samutprakarn - Phone: +66 2 738 96 20 - Fax: +66 2 738 96 29

<https://we-ef.com/asia>

Subject to technical changes and errors. - Generated on 23/11/2024

**Honeycomb louvre**

| Description         | Part ID  | C1  |
|---------------------|----------|-----|
| Honeycomb louvre IW | 139-1851 | 199 |

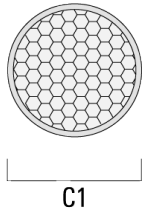
**Glare shield**

| Description     | Part ID  | A   | C1  |
|-----------------|----------|-----|-----|
| Glare shield ES | 139-1852 | 159 | 266 |



139-1830

FLC230 LED

**we-ef**

**Snoot**

---

| Description | Part ID  | A   | C1  |
|-------------|----------|-----|-----|
| Snoot ET    | 139-1853 | 160 | 266 |

---



---

**Wallwash lens**

---

| Description         | Part ID     | C1  |
|---------------------|-------------|-----|
| Wallwash lens IO-20 | 139-1848-AP | 199 |

---



---

**WE-EF LIGHTING (Thailand) Co., Ltd.**

57 Moo 5, Kingkaew Rd., Bangplee, 10540 Samutprakarn - Phone: +66 2 738 96 20 - Fax: +66 2 738 96 29

<https://we-ef.com/asia>

Subject to technical changes and errors. - Generated on 23/11/2024