

139-1831

FLC230 LED

we-ef



Description

IP66. Class I. IK07. Marine-grade, die-cast aluminum alloy. 5CE superior corrosion protection including PCS hardware. Silicone CCG® Controlled Compression Gasket. Safety glass lens. One cable gland, second gland for through wiring on request. CAD-optimized optics for superior illumination and glare control. Integral driver, thermally separated. OLC® One LED Concept. Factory-installed LED circuit board. 0-10V Dimming on request.

A maximum of one internal optical accessory.

Optional 2200K version available, except [VNS] version, to be specified at time of order.

Specify product with 7 Digit product code - Finish Color. Accessories, such as mounting, optical, and electrical, must be specified separately.

Example: XXX-XXXX-9004 (Black)
+ XXX-XXXX (Accessory 1)

| | |
|--------------------|------------------------------|
| Weight | 16.80 lb |
| Light distribution | symmetric, medium beam [M] |
| Light source | LED-12/24W / 700 mA - 4000 K |
| CRI | 80 |
| Power supply | electronic gear |
| LEDs | 12 |
| Rated input power | 27 W |

Nominal Lumen (lm)

| | |
|-------------|------|
| LED Lumen | 310 |
| Total Lumen | 3720 |
| Tj | 85 |

Rated lumens (lm)

| | |
|-------------|--------|
| LED Lumen | 280.8 |
| Total Lumen | 3369.7 |
| Ta | 25 |

WE-EF LIGHTING USA, LLC

410-D Keystone Drive, 15086 Warrendale, PA 15086 - Phone: +1 724 742 0030
customersupport.usa@we-ef.com - <https://we-ef.com/us>
Subject to technical changes and errors. - Generated on 11/23/2024

139-1831

FLC230 LED

we-ef

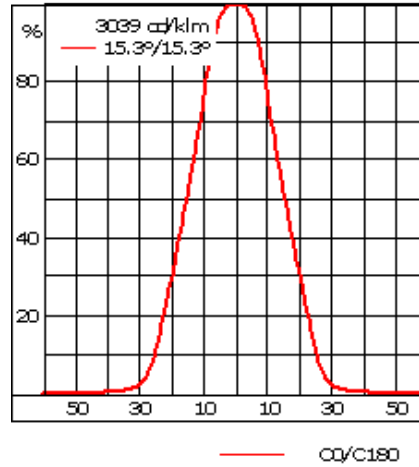
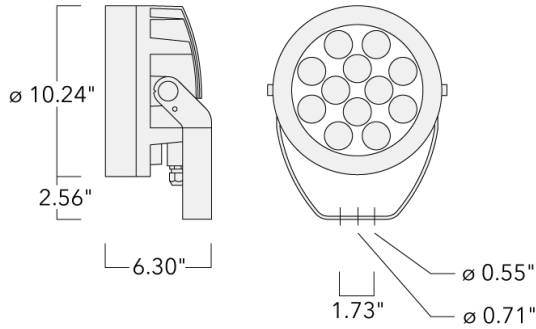

Specifications

Material description

| | |
|----------------------|---|
| Body | Marine-grade, die-cast aluminium alloy |
| Lens | Safety glass lens |
| Colors | <div style="display: flex; flex-direction: column; gap: 5px;"> <div> RAL9004 Black</div> <div> RAL9007 Grey Metallic</div> <div> RAL9016 White</div> <div> RAL8019 Dark Bronze</div> </div> |
| Gasket | Silicone CCG® Controlled Compression Gasket |
| Fasteners | PCS Polymer Coated Stainless Steel Hardware |
| Ingress protection | IP66 |
| Impact resistance | IK07 |
| Corrosion resistance | 5CE superior corrosion protection system |
| Windage | 0.684 |

WE-EF LIGHTING USA, LLC

410-D Keystone Drive, 15086 Warrendale, PA 15086 - Phone: +1 724 742 0030

customersupport.usa@we-ef.com - <https://we-ef.com/us>

Subject to technical changes and errors. - Generated on 11/23/2024

139-1831

FLC230 LED

we-ef

Electrical description

| | |
|------------------|---|
| Power supply | Integral [ECG] electronic driver 120V-277V. 0-10V dimmable, to be specified with order. |
| Driver / Ballast | Integral EC electronic converter in thermally-separated compartment |
| Power factor | > 0.9 |
| Surge protection | Integral 10kV Surge Protector |

Additional information

| | |
|----------|---|
| Lifetime | Ta=25°/40° L90B10 > 90000h |
| Listings | ETL, UL-1598, CSA-C22.2#250.0. Suitable for Wet Locations. Meets ANSI C136.31 - 3G Vibration Rating for Bridge and Overpass Applications. |

WE-EF LIGHTING USA, LLC

410-D Keystone Drive, 15086 Warrendale, PA 15086 - Phone: +1 724 742 0030
customersupport.usa@we-ef.com - <https://we-ef.com/us>
Subject to technical changes and errors. - Generated on 11/23/2024

139-1831

FLC230 LED

we-ef

Mounting Accessories

Short post EM

| Description | Part ID | D1 | D2 | H1 | M1 | Weight (lb) |
|---------------------------------|----------|-----|------|-------|-------|-------------|
| EM1-M16 AL - Single Cable Entry | 270-9038 | 6.3 | 5.12 | 7.87" | 0.35" | 4.85 lbs |



WE-EF LIGHTING USA, LLC

410-D Keystone Drive, 15086 Warrendale, PA 15086 - Phone: +1 724 742 0030
customersupport.usa@we-ef.com - <https://we-ef.com/us>

Subject to technical changes and errors. - Generated on 11/23/2024

Floodlight mounting bracket TA

| Description | Part ID | A | C1 | D × L1 | L | Weight (lb) | D × S |
|---|----------|---|------|----------|------|-------------|-----------|
| TA1 Mounting bracket, single (Ø 4.25 x 8) | 147-0096 | | 5.12 | 4.25 x 8 | 4.25 | 16.53 | 108 x 200 |

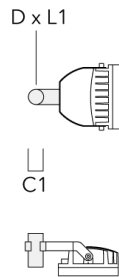

| | | | | | | | |
|---|----------|--|------|----------|------|-------|-----------|
| TA2 Mounting bracket, double (Ø 4.25 x 8) | 147-0097 | | 5.12 | 4.25 x 8 | 4.25 | 16.53 | 108 x 200 |
|---|----------|--|------|----------|------|-------|-----------|

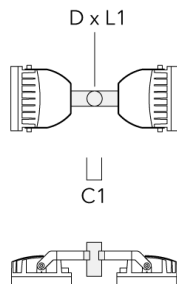

139-1831

FLC230 LED

we-ef

| Description | Part ID | A | C1 | D x L1 | L | Weight (lb) | D x S |
|---|----------|------|-------|----------|------|-------------|-----------|
| TA2-L Mounting bracket, double (Ø 4.25 x 8) | 147-0148 | ±90° | 16.54 | 4.25 x 8 | 4.25 | 44.53 | 108 x 200 |

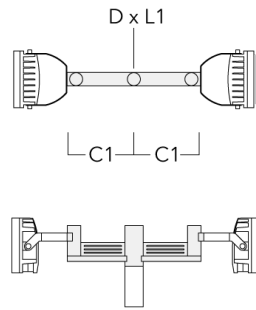

| | | | | | | | |
|--|----------|------|-------|-------|------|-------|----------|
| TA2-L Mounting bracket, double (Ø 3 x 8) | 147-0105 | ±90° | 16.54 | 3 x 8 | 2.99 | 35.49 | 76 x 200 |
|--|----------|------|-------|-------|------|-------|----------|

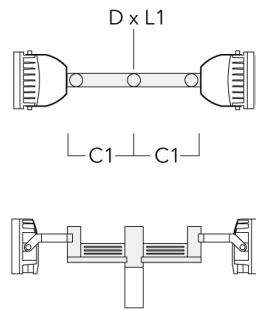

WE-EF LIGHTING USA, LLC

410-D Keystone Drive, 15086 Warrendale, PA 15086 - Phone: +1 724 742 0030
customersupport.usa@we-ef.com - <https://we-ef.com/us>

Subject to technical changes and errors. - Generated on 11/23/2024

139-1831

FLC230 LED

we-ef

| Description | Part ID | A | C1 | D x L1 | L | Weight (lb) | D x S |
|---|----------|------|-------|----------|-----|-------------|----------|
| TA3 Mounting bracket, triple (Ø 3.50 x 8) | 147-0025 | ±90° | 25.59 | 3.50 x 8 | 3.5 | 39.46 | 89 x 200 |

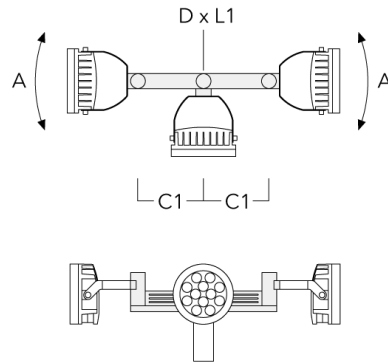

| | | | | | | | |
|---|----------|------|--------|----------|--|-----------|-----------|
| TA3 Mounting bracket, triple (Ø 4.25 x 8) | 147-0098 | ±90° | 25.59" | 4.25 x 8 | | 53.35 lbs | 108 x 200 |
|---|----------|------|--------|----------|--|-----------|-----------|

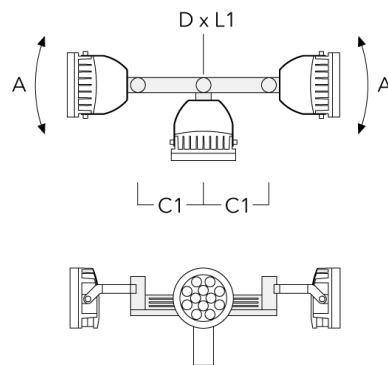

WE-EF LIGHTING USA, LLC

410-D Keystone Drive, 15086 Warrendale, PA 15086 - Phone: +1 724 742 0030
customersupport.usa@we-ef.com - <https://we-ef.com/us>

Subject to technical changes and errors. - Generated on 11/23/2024

139-1831

FLC230 LED

we-ef

| Description | Part ID | A | C1 | D x L1 | L | Weight (lb) | D x S |
|---|----------|------|-------|----------|---|-------------|----------|
| TA4 Mounting bracket, quad (Ø 3.50 x 8) | 147-0099 | ±90° | 25.59 | 3.50 x 8 | | 45.86 lbs | 89 x 200 |

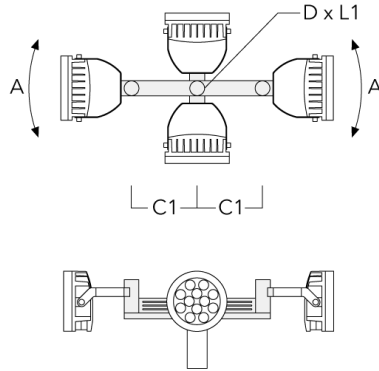

| | | | | | | | |
|---|----------|------|-------|----------|--|-------|-----------|
| TA4 Mounting bracket, quad (Ø 4.25 x 8) | 147-0100 | ±90° | 25.59 | 4.25 x 8 | | 53.00 | 108 x 200 |
|---|----------|------|-------|----------|--|-------|-----------|

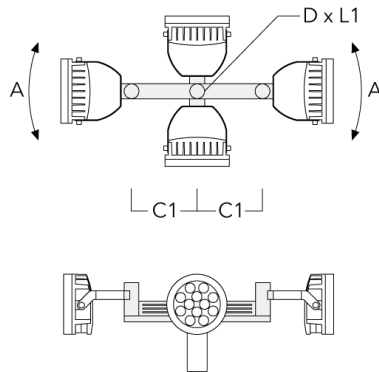

WE-EF LIGHTING USA, LLC

410-D Keystone Drive, 15086 Warrendale, PA 15086 - Phone: +1 724 742 0030
customersupport.usa@we-ef.com - <https://we-ef.com/us>

Subject to technical changes and errors. - Generated on 11/23/2024

139-1831

we-ef

FLC230 LED

| Description | Part ID | A | C1 | D × L1 | L | Weight (lb) | D × S |
|--|----------|---|------|--------|------|-------------|----------|
| TA2 Mounting bracket, double (Ø 3 x 8) | 147-0024 | | 5.12 | 3 x 8 | 2.99 | 4.2 lbs | 76 x 200 |

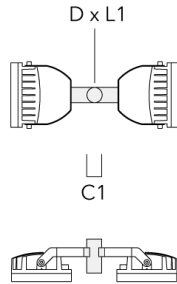

| | | | | | | | |
|--|----------|--|------|-------|------|------|----------|
| TA1 Mounting bracket, single (Ø 3 x 8) | 147-0023 | | 5.12 | 3 x 8 | 2.99 | 4.19 | 76 x 200 |
|--|----------|--|------|-------|------|------|----------|

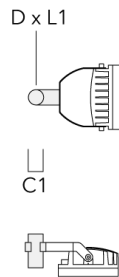

WE-EF LIGHTING USA, LLC

410-D Keystone Drive, 15086 Warrendale, PA 15086 - Phone: +1 724 742 0030
customersupport.usa@we-ef.com - <https://we-ef.com/us>

Subject to technical changes and errors. - Generated on 11/23/2024

139-1831

we-ef

FLC230 LED

Pole clamp TS

| Description | Part ID | D1 | Weight(lb) | D |
|--|----------|----------|------------|---------|
| TS1-2/M12 Pole clamp, single (Ø 4.0"-4.5") | 147-0526 | 4.0-4.50 | 3.53 | 102-114 |



| | | | | |
|---|----------|---------|------|---------|
| TS1-2/M12 Pole clamp, single (Ø 4.5"-5.25") | 147-0544 | 114-133 | 3.75 | 114-133 |
|---|----------|---------|------|---------|

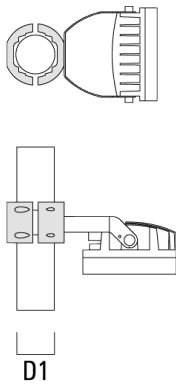

WE-EF LIGHTING USA, LLC

410-D Keystone Drive, 15086 Warrendale, PA 15086 - Phone: +1 724 742 0030
customersupport.usa@we-ef.com - <https://we-ef.com/us>
Subject to technical changes and errors. - Generated on 11/23/2024

139-1831

we-ef

FLC230 LED

| Description | Part ID | D1 | Weight (lb) | D |
|--|----------|----------|-------------|-------|
| TS1-2/M12 Pole clamp, single (Ø 3"-3.5") | 147-0543 | 3.0-3.50 | 3.31 | 76-89 |

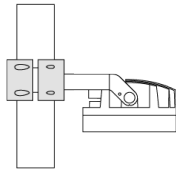
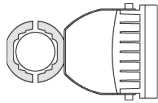

D1

| | | | | |
|--|----------|-----------|----------|-------|
| TS2-2/M12 Pole clamp, double (Ø 3"-3.5") | 147-0545 | 3.0"-3.5" | 3.09 lbs | 76-89 |
|--|----------|-----------|----------|-------|

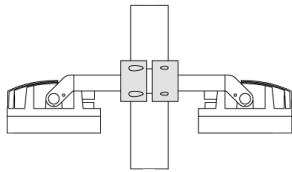
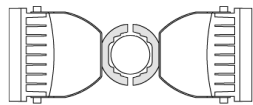

D1

WE-EF LIGHTING USA, LLC

410-D Keystone Drive, 15086 Warrendale, PA 15086 - Phone: +1 724 742 0030
customersupport.usa@we-ef.com - <https://we-ef.com/us>

Subject to technical changes and errors. - Generated on 11/23/2024

139-1831

we-ef

FLC230 LED

| Description | Part ID | D1 | Weight (lb) | D |
|---|----------|-----------|-------------|---------|
| TS2-2/M16 Pole clamp, double (Ø 4.5"-5.25") | 147-0546 | 4.50-5.25 | 3.53 | 114-133 |

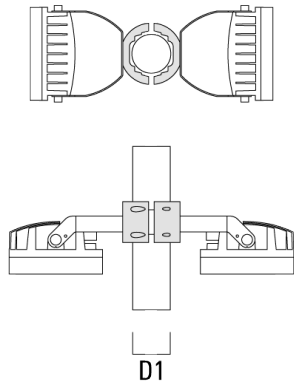

Planted root

| Description | Part ID | D1 | D2 | D3 | D4 | H1 | H2 | M1 | Weight (lb) |
|-------------------|----------|------|------|------|------|-------|-------|-----|-------------|
| Planted root ESV4 | 300-0461 | 5.71 | 5.12 | 4.01 | 4.25 | 15.75 | 13.78 | .31 | 15.54 |

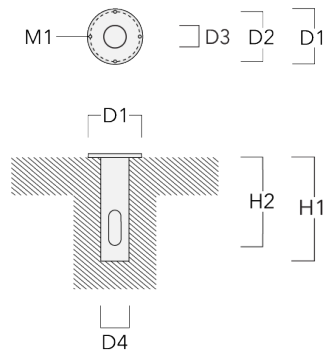

WE-EF LIGHTING USA, LLC

410-D Keystone Drive, 15086 Warrendale, PA 15086 - Phone: +1 724 742 0030
customersupport.usa@we-ef.com - <https://we-ef.com/us>

Subject to technical changes and errors. - Generated on 11/23/2024

139-1831

FLC230 LED

we-ef

Pole top caps KF

| Description | Part ID | D1 | D × L1 | Weight (lb) | D |
|----------------------------------|----------|------|----------|-------------|----------|
| KF16-60/M16 Spigot Cap (Ø 2.36") | 310-9120 | 2.36 | 2.36 x 4 | 4.4 lbs | 60 x 100 |

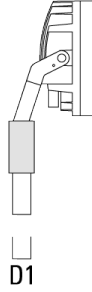

| | | | | | |
|---------------------------------|----------|---|-------|----------|----------|
| KF16-76/M16 Spigot Cap (Ø 3.0") | 310-9121 | 3 | 3 x 4 | 1.10 lbs | 76 x 100 |
|---------------------------------|----------|---|-------|----------|----------|



WE-EF LIGHTING USA, LLC

410-D Keystone Drive, 15086 Warrendale, PA 15086 - Phone: +1 724 742 0030
customersupport.usa@we-ef.com - <https://we-ef.com/us>

Subject to technical changes and errors. - Generated on 11/23/2024

139-1831

FLC230 LED

we-ef

| Description | Part ID | D1 | D × L1 | Weight (lb) | D |
|---------------------------------|----------|------|---------|-------------|----|
| KF16-89/M16 Spigot Cap (Ø 3.5") | 300-0734 | 3.50 | 3.5 x 3 | 1.10 lbs | 89 |



| | | | | | |
|-----------------------------------|----------|------|----------|---------|-----|
| KF16-108/M16 Spigot Cap (Ø 4.25") | 300-0735 | 4.25 | 4.25 x 3 | 4.4 lbs | 108 |
|-----------------------------------|----------|------|----------|---------|-----|



WE-EF LIGHTING USA, LLC

410-D Keystone Drive, 15086 Warrendale, PA 15086 - Phone: +1 724 742 0030
customersupport.usa@we-ef.com - <https://we-ef.com/us>

Subject to technical changes and errors. - Generated on 11/23/2024

Wall Mount Bracket WMB

| Description | Part ID | C1 | C2 | D1 | D2 | H1 | M1 | M2 | Weight (lb) |
|---------------------------|----------|-------|------|------|------|-------|------|------|-------------|
| WMB200 Wall mount bracket | 147-6015 | 20.28 | 4.72 | 9.25 | 7.88 | 11.34 | 1.05 | 0.47 | 20.0 lbs |

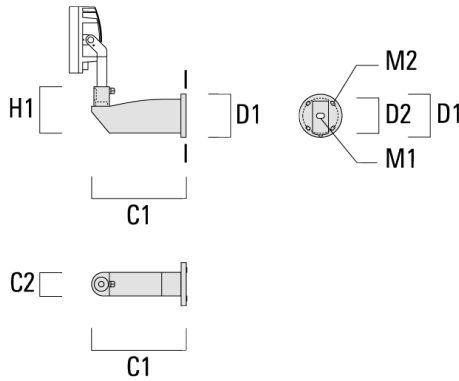

Surface Mount Canopy SMC

| Description | Part ID | D1 | D2 | Weight (lb) |
|-------------|----------|-------|------|-------------|
| SMC-200 | 147-6915 | 10.83 | 9.25 | 15.4 lbs |

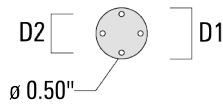

Junction box

| Description | Part ID | Additional information | A | B | C1 | Weight (lb) |
|--|----------|--|------|------|------|-------------|
| Junction box JB20 - Cable side entries | 310-9013 | Junction boxes are made from marine-grade, die-cast aluminium alloy. IK10. IP66. For side entries and suitable to be used with cable glands. | 7.09 | 5.63 | 2.01 | 2.25 |

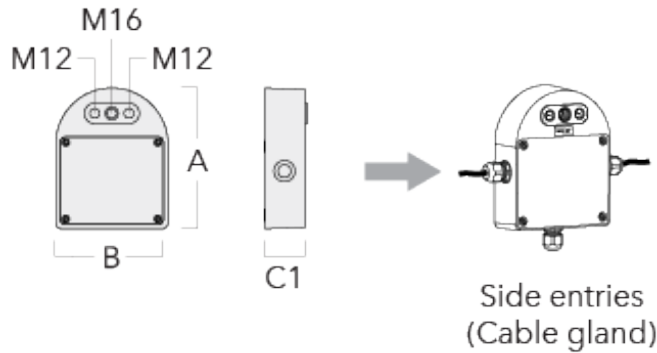

| | | | | | | |
|--|----------|--|------|------|------|------|
| Junction box JB20 - Conduit side entries | 310-9014 | Junction boxes are made from marine-grade, die-cast aluminium alloy. IK10. IP66. For side entries and suitable to be used with conduits. | 7.09 | 5.63 | 2.01 | 2.25 |
|--|----------|--|------|------|------|------|

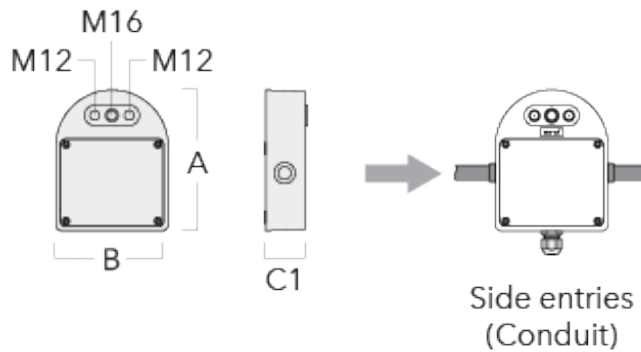

139-1831

we-ef

FLC230 LED

Pole clamp PC

| Description | Part ID | D1 | Weight (lb) |
|---|----------|----------|-------------|
| PC2 76-89/60 Pole clamp, double (Ø 3"-3.5") | 139-2703 | 3.0-3.50 | 2.20 |

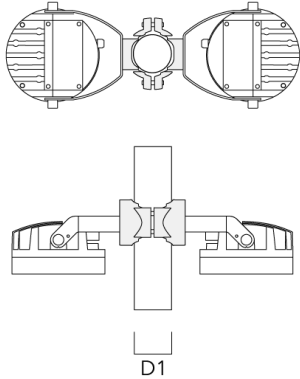

| | | | |
|---|----------|----------|------|
| PC1 76-89/60 Pole clamp, single (Ø 3"-3.5") | 139-2702 | 3.0-3.50 | 2.20 |
|---|----------|----------|------|

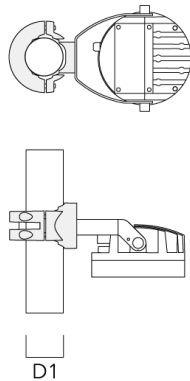

WE-EF LIGHTING USA, LLC

410-D Keystone Drive, 15086 Warrendale, PA 15086 - Phone: +1 724 742 0030
customersupport.usa@we-ef.com - <https://we-ef.com/us>
Subject to technical changes and errors. - Generated on 11/23/2024

139-1831

we-ef

FLC230 LED

| Description | Part ID | D1 | Weight (lb) |
|--|----------|----------|-------------|
| PC2 102-114/60 Pole clamp, double (Ø 4"-4.5") | 139-2707 | 4.0-4.50 | 2.65 |



| | | | |
|--|----------|----------|------|
| PC1 102-114/60 Pole clamp, single (Ø 4"-4,5") | 139-2706 | 4.0-4.50 | 2.65 |
|--|----------|----------|------|



WE-EF LIGHTING USA, LLC

410-D Keystone Drive, 15086 Warrendale, PA 15086 - Phone: +1 724 742 0030

customersupport.usa@we-ef.com - <https://we-ef.com/us>

Subject to technical changes and errors. - Generated on 11/23/2024

139-1831

we-ef

FLC230 LED

| Description | Part ID | D1 | Weight (lb) |
|---|----------|----------|-------------|
| PC2 114-133/60 Pole clamp, double (Ø 4.5"-5.25") | 139-2709 | 4.5-5.25 | 3.10 |



| | | | |
|---|----------|----------|------|
| PC1 114-133/60 Pole clamp, single (Ø 4.5"-5.25") | 139-2708 | 4.5-5.25 | 3.10 |
|---|----------|----------|------|



WE-EF LIGHTING USA, LLC

410-D Keystone Drive, 15086 Warrendale, PA 15086 - Phone: +1 724 742 0030
customersupport.usa@we-ef.com - <https://we-ef.com/us>

Subject to technical changes and errors. - Generated on 11/23/2024

139-1831

we-ef

FLC230 LED

| Description | Part ID | D1 | Weight (lb) |
|---|----------|-----------|-------------|
| PC2 82-109/60 Pole clamp, double (Ø 3.25"-4.25") | 139-2705 | 3.20-4.30 | 2.40 |

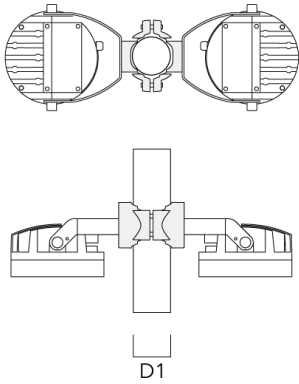

| | | | |
|--|----------|-----------|------|
| PC1 82-109/60 Pole camp, single (Ø 3.25"-4.3") | 139-2704 | 3.20-4.30 | 2.40 |
|--|----------|-----------|------|



WE-EF LIGHTING USA, LLC

410-D Keystone Drive, 15086 Warrendale, PA 15086 - Phone: +1 724 742 0030
customersupport.usa@we-ef.com - <https://we-ef.com/us>
Subject to technical changes and errors. - Generated on 11/23/2024

139-1831

FLC230 LED

we-ef

Optical Accessories

Linear spread lens

| Description | Part ID | C1 |
|-------------------|----------|------|
| 10-180-FLC230-LED | 139-1849 | 7.83 |

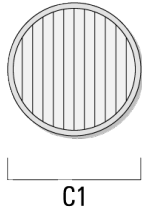

WE-EF LIGHTING USA, LLC

410-D Keystone Drive, 15086 Warrendale, PA 15086 - Phone: +1 724 742 0030
customersupport.usa@we-ef.com - <https://we-ef.com/us>

Subject to technical changes and errors. - Generated on 11/23/2024

139-1831

FLC230 LED

we-ef

Softening Lens

| Description | Part ID | C1 |
|-------------------|----------|------|
| IO-360-FLC230-LED | 139-1850 | 7.83 |

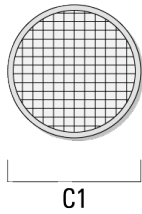

Honeycomb louvre

| Description | Part ID | C1 |
|---------------|----------|------|
| IW-FLC230-LED | 139-1851 | 7.83 |

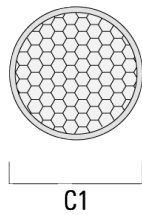

WE-EF LIGHTING USA, LLC

410-D Keystone Drive, 15086 Warrendale, PA 15086 - Phone: +1 724 742 0030
customersupport.usa@we-ef.com - <https://we-ef.com/us>

Subject to technical changes and errors. - Generated on 11/23/2024

Glare shield

| Description | Part ID | A | C1 |
|---------------|----------|------|-------|
| ES-FLC230-LED | 139-1852 | 6.26 | 10.47 |

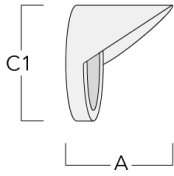

Snoot

| Description | Part ID | A | C1 |
|---------------|----------|-----|-------|
| ET-FLC230-LED | 139-1853 | 6.3 | 10.47 |

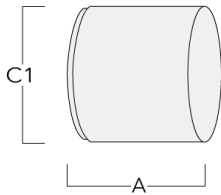

139-1831

FLC230 LED

we-ef

Wallwash lens

| Description | Part ID | C1 |
|------------------|----------|------|
| 10-20-FLC230-LED | 139-1848 | 7.83 |

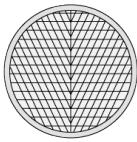

C1

WE-EF LIGHTING USA, LLC

410-D Keystone Drive, 15086 Warrendale, PA 15086 - Phone: +1 724 742 0030
customersupport.usa@we-ef.com - <https://we-ef.com/us>

Subject to technical changes and errors. - Generated on 11/23/2024