



Beschreibung

IP66, SKI. SKII auf Anfrage. IK07. Korrosionsbeständiger Aluminiumguss. PCS beschichtete Edelstahlschrauben. 5CE Korrosionsschutz. CCG® Controlled Compression Gasket Silikondichtung. Sicherheitsglas. Eine Kabelverschraubung, eine zweite Kabelverschraubung zur Durchverdrahtung auf Anfrage. Eingebaute elektronische Betriebsgeräte, thermisch getrennt. CAD-optimierte OLC® One LED Concept Technik zur Lichtlenkung und Entblendung. Eingebaute LED Platine. 1-10V, DALI Schnittstelle oder Eco Step Dim® auf Anfrage. Maximal ein internes Zubehörteil möglich. Variante mit 2200 K bis max. 1050 mA erhältlich, nicht für [EES] Version. Bei Bestellung bitte angeben.

Gewicht	7.60 kg
Lichtverteilung	symmetrisch extrem engstrahlend [EE]
Lichtquelle	LED-12/36W / 1050 mA - 4000 K
CRI	80
Netz	EVG
LEDs	12
Bemessungsleistung	41 W
Nominal Lichtstrom (lm)	
LED Lumen	450
Total Lumen	5400
Tj	85
Bemessungslichtstrom (lm)	
LED Lumen	403.5
Total Lumen	4842.2
Ta	25

WE-EF Switzerland AG

Himmelrichstrasse 6, 6003 Luzern - Tel: +41 41 210 49 95
info.switzerland@we-ef.com - https://we-ef.com/ch_de
Technische Änderungen und Irrtümer vorbehalten. - Erstellt am 23.11.2024



Spezifikationen

Materialbeschreibung

Gehäuse	Korrosionsbeständiger Aluminiumguss
Abdeckung	Sicherheitsglasscheibe
Farben	<div style="display: flex; align-items: center;"> <div style="width: 20px; height: 10px; background-color: black; margin-right: 5px;"></div> RAL9004 Signalschwarz </div> <div style="display: flex; align-items: center; margin-top: 5px;"> <div style="width: 20px; height: 10px; background-color: gray; margin-right: 5px;"></div> RAL9007 Graualuminium </div> <div style="display: flex; align-items: center; margin-top: 5px;"> <div style="width: 20px; height: 10px; background-color: darkgray; margin-right: 5px;"></div> RAL7016 Anthrazitgrau </div> <div style="display: flex; align-items: center; margin-top: 5px;"> <div style="width: 20px; height: 10px; background-color: lightgray; margin-right: 5px;"></div> RAL9016 Verkehrsweiß </div>
Dichtung	CCG® Silikondichtung
Schrauben	PCS beschichtete Edelstahlschrauben
Schutzart	IP66
Schlagfestigkeit	IK07
Korrosionsbeständigkeit	5CE
Windangriffsfläche	0.054 m ²

Elektrische Beschreibung

Netz	220-240V / 50-60 Hz
Netzgerät / Vorschaltgerät	Standard. Variante mit DALI erhältlich, bei Bestellung bitte angeben.
Leistungsfaktor	> 0.9
Überspannungsschutz	6/6 kV (optional SP10)

WE-EF Switzerland AG

139-1841

FLC230 LED

we-ef

Weitere Informationen

Lebensdauer Ta=25° L90B10 > 90000h

Energieeffizienzklasse C-D (Lichtquelle)

WE-EF Switzerland AG

Himmelrichstrasse 6, 6003 Luzern - Tel: +41 41 210 49 95

info.switzerland@we-ef.com - https://we-ef.com/ch_de

Technische Änderungen und Irrtümer vorbehalten. - Erstellt am 23.11.2024

139-1841

FLC230 LED

we-ef

Montagezubehör

Montagesockel EM

Beschreibung	Artikelnummer	D1	D2	H1	M1	Gewicht (kg)
EM1-M16 AL	270-9038	160	130	203	9	2

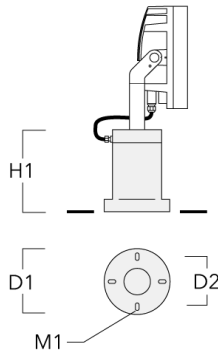

Mastaufsatztraverse TA

Beschreibung	Artikelnummer	A	C1	D x L1	Gewicht (kg)	D x S
TA1 Mastaufsatztraverse, einfach (Ø 108 x 200)	147-0096		130	108 x 200	7.50	108 x 200

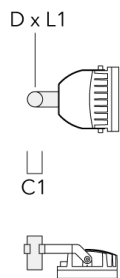

WE-EF Switzerland AG

Himmelrichstrasse 6, 6003 Luzern - Tel: +41 41 210 49 95

info.switzerland@we-ef.com - https://we-ef.com/ch_de

Technische Änderungen und Irrtümer vorbehalten. - Erstellt am 23.11.2024

Beschreibung	Artikelnummer	A	C1	D x L1	Gewicht (kg)	D x S
TA2 Mastaufsatztraverse, zweifach (Ø 108 x 200)	147-0097		130	108 x 200	7.50	108 x 200



TA2-L Mastaufsatztraverse, zweifach (Ø 108 x 200)	147-0148	±90°	420	108 x 200	20.20	108 x 200
---	----------	------	-----	-----------	-------	-----------



Beschreibung	Artikelnummer	A	C1	D x L1	Gewicht (kg)	D x S
TA2-L Mastaufsatztraverse, zweifach (Ø 76 x 200)	147-0105	±90°	420	76 x 200	16.10	76 x 200



TA3 Mastaufsatztraverse, dreifach (Ø 89 x 200)	147-0025	±90°	650	89 x 200	17.90	89 x 200
--	----------	------	-----	----------	-------	----------



Beschreibung	Artikelnummer	A	C1	D x L1	Gewicht (kg)	D x S
TA3 Mastaufsatztraverse, dreifach (Ø 108 x 200)	147-0098	±90°	650	108 x 200	24.20	108 x 200

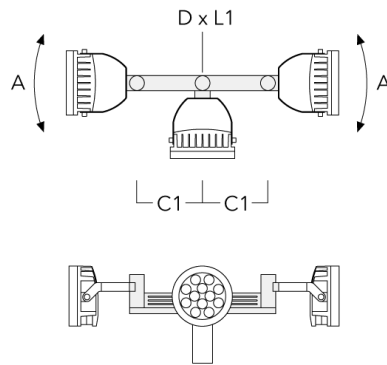

TA4 Mastaufsatztraverse, vierfach (Ø 89 x 200)	147-0099	±90°	650	89 x 200	20.80	89 x 200
--	----------	------	-----	----------	-------	----------

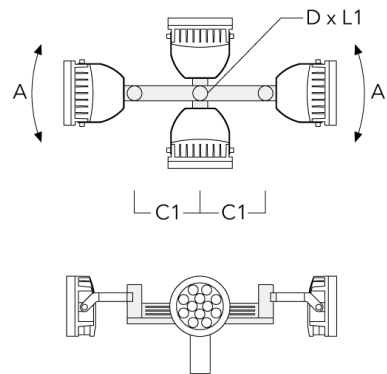

Beschreibung	Artikelnummer	A	C1	D x L1	Gewicht (kg)	D x S
TA4 Mastaufsatztraverse, vierfach (Ø 108 x 200)	147-0100	±90°	650	108 x 200	24.20	108 x 200



TA2 Mastaufsatztraverse, zweifach (Ø 76 x 200)	147-0024		130	76 x 200	1.90	76 x 200
--	----------	--	-----	----------	------	----------



Beschreibung	Artikelnummer	A	C1	D × L1	Gewicht (kg)	D × S
TA1 Mastaufsatztraverse, einfach* (Ø 76 x 200)	147-0023		130	76 x 200	1.50	76 x 200



Mastschelle TS

Beschreibung	Artikelnummer	D1	Gewicht (kg)	D
TS1-2/M12 Mastschelle, einfach (Ø 102-114)	147-0526	102-114	1.50	102-114

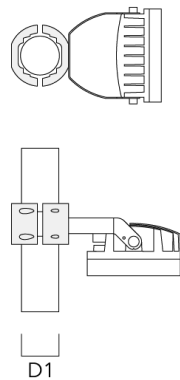

Beschreibung	Artikelnummer	D1	Gewicht (kg)	D
TS1-2/M12 Mastschelle, einfach (Ø 114-133)	147-0544	114-133	1.70	114-133

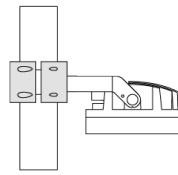

D1

TS1-2/M12 Mastschelle, einfach (Ø 76-89)	147-0543	76-89	1.40	76-89
--	----------	-------	------	-------

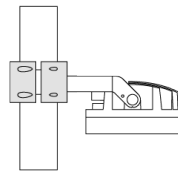
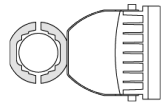

D1

139-1841

FLC230 LED

we-ef

Beschreibung	Artikelnummer	D1	Gewicht (kg)	D
TS2-2/M12 Mastschelle, zweifach (Ø 76-89)	147-0545	76-89	1.40	76-89



TS2-2/M12 Mastschelle, zweifach (Ø 114-133)	147-0546	114-133	1.60	114-133
---	----------	---------	------	---------



WE-EF Switzerland AG

Himmelrichstrasse 6, 6003 Luzern - Tel: +41 41 210 49 95
info.switzerland@we-ef.com - https://we-ef.com/ch_de
Technische Änderungen und Irrtümer vorbehalten. - Erstellt am 23.11.2024

Beschreibung	Artikelnummer	D1	Gewicht (kg)	D
TS2-2/M12 Mastschelle, zweifach (Ø 102-114)	147-0527	102-114	1.50	102-114

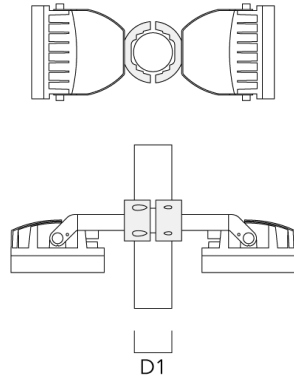

Erdstück

Beschreibung	Artikelnummer	D1	D2	D3	D4	H1	H2	M1	Gewicht (kg)
Erdstück ESV4	300-0461	145	130	102	108	400	350	8	7.05

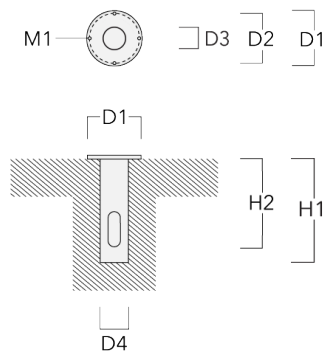

139-1841

FLC230 LED

we-ef

Mastschelle PC

Beschreibung	Artikelnummer	D1	Gewicht (kg)
PC2 76-89/60 Mastschelle, zweifach (Ø 76-89)	139-2703	76-89	1.00

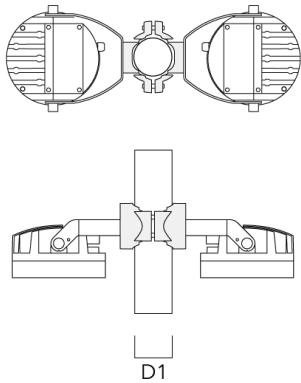

PC1 76-89/60 Mastschelle, einfach (Ø 76-89)	139-2702	76-89	1.00
--	----------	-------	------



WE-EF Switzerland AG

Himmelrichstrasse 6, 6003 Luzern - Tel: +41 41 210 49 95

info.switzerland@we-ef.com - https://we-ef.com/ch_de

Technische Änderungen und Irrtümer vorbehalten. - Erstellt am 23.11.2024

Beschreibung	Artikelnummer	D1	Gewicht (kg)
PC2 102-114/60 Mastschelle, zweifach (Ø 102-114)	139-2707	102-114	1.20



PC1 102-114/60 Mastschelle, einfach (Ø 102-114)	139-2706	102-114	1.20
--	----------	---------	------



Beschreibung	Artikelnummer	D1	Gewicht (kg)
PC2 114-133/60 Mastschelle, zweifach (Ø 114-133)	139-2709	114-133	1.40



PC1 114-133/60 Mastschelle, einfach (Ø 114-133)	139-2708	114-133	1.40
--	----------	---------	------

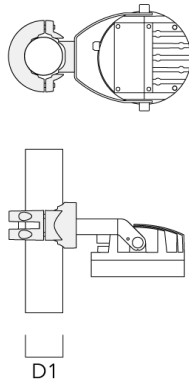

139-1841

FLC230 LED

we-ef

Beschreibung	Artikelnummer	D1	Gewicht (kg)
PC2 82-109/60 Mastschelle, zweifach (Ø 82-109)	139-2705	82-109	1.10



PC1 82-109/60 Mastschelle, einfach (Ø 82-109)	139-2704	82-109	1.10
--	----------	--------	------



WE-EF Switzerland AG

Himmelrichstrasse 6, 6003 Luzern - Tel: +41 41 210 49 95

info.switzerland@we-ef.com - https://we-ef.com/ch_de

Technische Änderungen und Irrtümer vorbehalten. - Erstellt am 23.11.2024

139-1841

FLC230 LED

we-ef

Steuerung

Eco Step Dim® Basic

Beschreibung	Artikelnummer
Eco Step Dim® Basic LED	430-0001

Eco Step Dim® Advanced

Beschreibung	Artikelnummer
Eco Step Dim® Advanced LED	430-0002

R2C Ready to Connect

Beschreibung	Artikelnummer
R2C Ready to Connect (oben)	430-0019

WE-EF Switzerland AG

Himmelrichstrasse 6, 6003 Luzern - Tel: +41 41 210 49 95

info.switzerland@we-ef.com - https://we-ef.com/ch_de

Technische Änderungen und Irrtümer vorbehalten. - Erstellt am 23.11.2024

139-1841

FLC230 LED

we-ef

Optisches Zubehör

Streulinse bandförmig

Beschreibung	Artikelnummer	C1
IO-180-FLC230-LED	139-1849	199

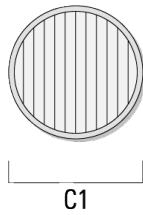

Streulinse allseitig

Beschreibung	Artikelnummer	C1
IO-360-FLC230-LED	139-1850	199

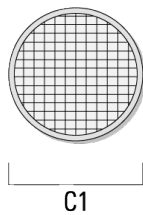

WE-EF Switzerland AG

Himmelrichstrasse 6, 6003 Luzern - Tel: +41 41 210 49 95

info.switzerland@we-ef.com - https://we-ef.com/ch_de

Technische Änderungen und Irrtümer vorbehalten. - Erstellt am 23.11.2024

Wabenblende

Beschreibung	Artikelnummer	C1
IW-FLC230-LED - [E][EE][EES]	139-1851	199

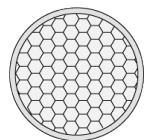

C1

Seitenblende

Beschreibung	Artikelnummer	A	C1
Seitenblende ES	139-1852	159	266

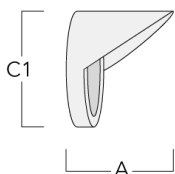

Abblendtubus

Beschreibung	Artikelnummer	A	C1
Abblendtubus ET	139-1853	160	266

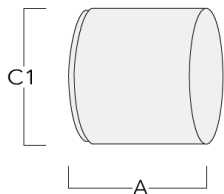
**Wallwash Linse**

Beschreibung	Artikelnummer	C1
IO-20-FLC230-LED	139-1848	199

