



### Description

IP66, Class I. Class II on request.

IK07. Marine-grade, die-cast aluminium alloy. 5CE superior corrosion protection including PCS hardware. Silicone CCG® Controlled Compression Gasket. Safety glass lens. One cable gland. Second gland for through wiring on request. Integral EC electronic converter, thermally separated. CAD-optimised optics for superior illumination and glare control. OLC® One LED Concept. Factory installed LED circuit board. 1-10V, DALI Interface or Eco Step Dim® on request. Maximum one internal optical accessory possible.

Optional 2200 K version up to max. 1050mA available, except version [EES]. To be specified at time of ordering.

Weight	7.60 kg
Light distribution	symmetric, very narrow beam [EE]
Light source	LED-12/52W / 1400 mA - 3000 K
CRI	80
Power supply	EC
LEDs	12
Rated input power	55 W
<b>Nominal Lumen (lm)</b>	
LED Lumen	550
Total Lumen	6600
Tj	85
<b>Rated lumens (lm)</b>	
LED Lumen	483.3
Total Lumen	5800
Ta	25

139-1846

FLC230 LED

we-ef

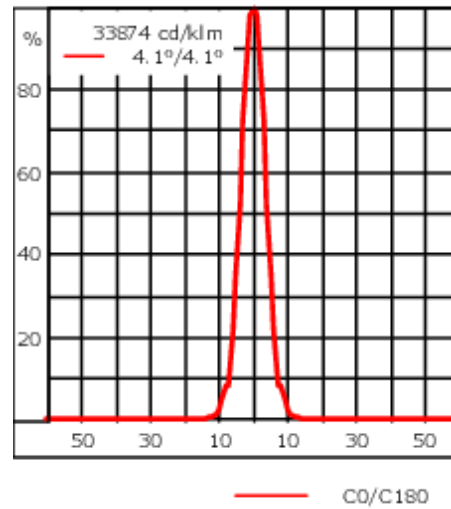
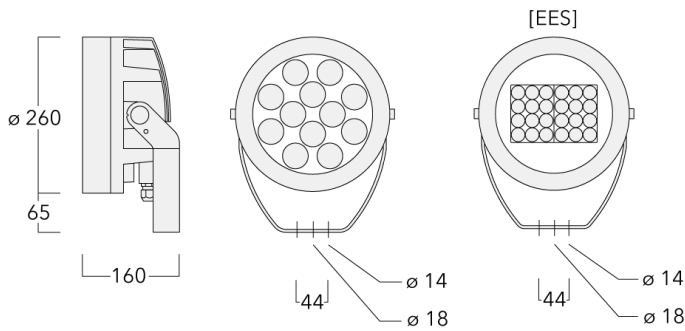

## Specifications

### Material description

Body	Marine-grade, die-cast aluminium alloy
Lens	Safety glass lens
Colours	<ul style="list-style-type: none"><li><span style="display: inline-block; width: 20px; height: 10px; background-color: black; margin-right: 5px;"></span> RAL9004 Signal black</li><li><span style="display: inline-block; width: 20px; height: 10px; background-color: #cccccc; margin-right: 5px;"></span> RAL9006 White aluminium</li><li><span style="display: inline-block; width: 20px; height: 10px; background-color: #808080; margin-right: 5px;"></span> RAL9007 Grey aluminium</li><li><span style="display: inline-block; width: 20px; height: 10px; background-color: #333333; margin-right: 5px;"></span> RAL7016 Anthracite grey</li><li><span style="display: inline-block; width: 20px; height: 10px; background-color: #e0e0e0; margin-right: 5px;"></span> RAL9016 Traffic white</li></ul>
Gasket	Silicone CCG® Controlled Compression Gasket
Fasteners	PCS Polymer Coated Stainless Steel Hardware
Ingress protection	IP66
Impact resistance	IK07
Corrosion resistance	5CE
Windage	0.054 m <sup>2</sup>

### Electrical description

Power supply	220-240V / 50-60 Hz
Driver / Ballast	Standard. Optional DALI version available. To be specified at time of ordering.
Power factor	> 0.9
Surge protection	6/6 kV (optional SP10)

#### WE-EF LEUCHTEN GmbH

Töpinger Straße 16, 29646 Bispingen, Germany - Phone: +49 5194 909-0  
info@we-ef.com - <https://we-ef.com>

Subject to technical changes and errors. - Generated on 23/11/2024

**139-1846**

**FLC230 LED**

**we-ef**

**Additional information**

---

Lifetime Ta=25° L90B10 > 90000h

Energy efficiency class C-D (Light source)

---

**WE-EF LEUCHTEN GmbH**

Töpinger Straße 16, 29646 Bispingen, Germany - Phone: +49 5194 909-0  
info@we-ef.com - <https://we-ef.com>

Subject to technical changes and errors. - Generated on 23/11/2024

**Mounting Accessories**

**Short post EM**

Description	Part ID	D1	D2	H1	M1	Weight (kg)
EM1-M16 AL	270-9038	160	130	203	9	2

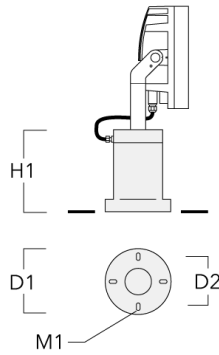

**Floodlight mounting bracket TA**

Description	Part ID	A	C1	D x L1	Weight (kg)	D x S
TA1 Mounting bracket, single (Ø 108 x 200)	147-0096		130	108 x 200	7.50	108 x 200



139-1846

FLC230 LED

**we-ef**

Description	Part ID	A	C1	D x L1	Weight (kg)	D x S
TA2 Mounting bracket, double (Ø 108 x 200)	147-0097		130	108 x 200	7.50	108 x 200



TA2-L Mounting bracket, double (Ø 108 x 200)	147-0148	±90°	420	108 x 200	20.20	108 x 200
--	----------	------	-----	-----------	-------	-----------

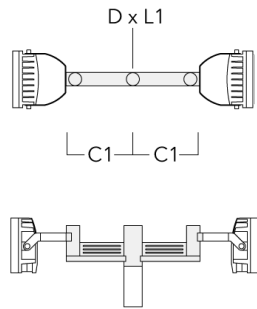

**WE-EF LEUCHTEN GmbH**

Töpinger Straße 16, 29646 Bispingen, Germany - Phone: +49 5194 909-0  
info@we-ef.com - <https://we-ef.com>

Subject to technical changes and errors. - Generated on 23/11/2024

**FLC230 LED**

Description	Part ID	A	C1	D x L1	Weight (kg)	D x S
TA2-L Mounting bracket, double (Ø 76 x 200)	147-0105	±90°	420	76 x 200	16.10	76 x 200

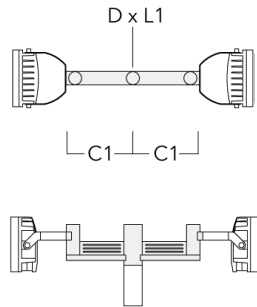

TA3 Mounting bracket, triple (Ø 89 x 200)	147-0025	±90°	650	89 x 200	17.90	89 x 200
---	----------	------	-----	----------	-------	----------

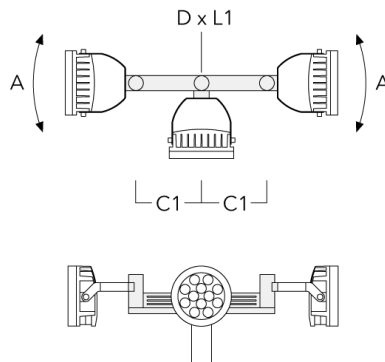

139-1846

FLC230 LED

**we-ef**

Description	Part ID	A	C1	D x L1	Weight (kg)	D x S
TA3 Mounting bracket, triple (Ø 108 x 200)	147-0098	±90°	650	108 x 200	24.20	108 x 200

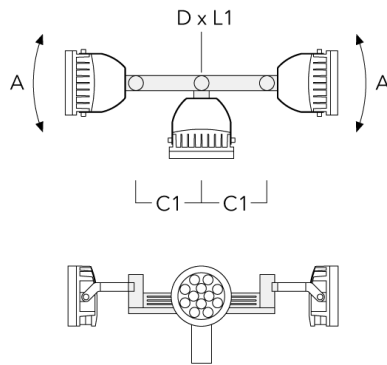

TA4 Mounting bracket, quad (Ø 89 x 200)	147-0099	±90°	650	89 x 200	20.80	89 x 200
---	----------	------	-----	----------	-------	----------

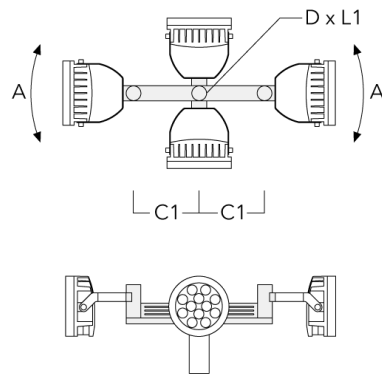

**WE-EF LEUCHTEN GmbH**

Töpinger Straße 16, 29646 Bispingen, Germany - Phone: +49 5194 909-0  
info@we-ef.com - <https://we-ef.com>

Subject to technical changes and errors. - Generated on 23/11/2024

**FLC230 LED**

Description	Part ID	A	C1	D x L1	Weight (kg)	D x S
TA4 Mounting bracket, quad (Ø 108 x 200)	147-0100	±90°	650	108 x 200	24.20	108 x 200



TA2 Mounting bracket, double* (Ø 76 x 200)	147-0024		130	76 x 200	1.90	76 x 200
--	----------	--	-----	----------	------	----------

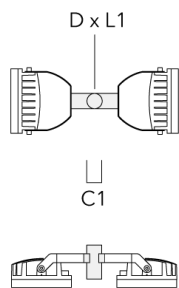



**FLC230 LED**

Description	Part ID	A	C1	D × L1	Weight (kg)	D × S
TA1 Mounting bracket, single* (Ø 76 x 200)	147-0023		130	76 x 200	1.50	76 x 200

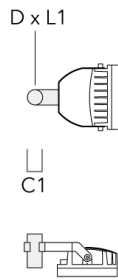

**Pole clamp TS**

Description	Part ID	D1	Weight (kg)	D
TS1-2/M12 Pole clamp, single (Ø 102-114)	147-0526	102-114	1.50	102-114

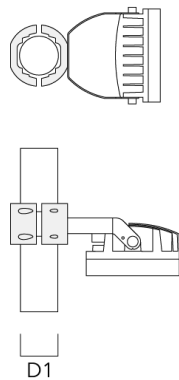

139-1846

FLC230 LED

**we-ef**

---

Description	Part ID	D1	Weight (kg)	D
TS1-2/M12 Pole clamp, single (Ø 114-133)	147-0544	114-133	1.70	114-133

---

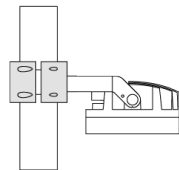
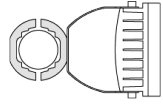

D1

---

TS1-2/M12 Pole clamp, single (Ø 76-89)	147-0543	76-89	1.40	76-89
--	----------	-------	------	-------

---

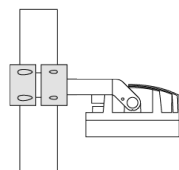
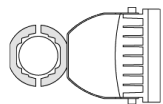

D1

**WE-EF LEUCHTEN GmbH**

Töpinger Straße 16, 29646 Bispingen, Germany - Phone: +49 5194 909-0  
info@we-ef.com - <https://we-ef.com>

Subject to technical changes and errors. - Generated on 23/11/2024

**FLC230 LED**

Description	Part ID	D1	Weight (kg)	D
TS2-2/M12 Pole clamp, double (Ø 76-89)	147-0545	76-89	1.40	76-89



TS2-2/M12 Pole clamp, double (Ø 114-133)	147-0546	114-133	1.60	114-133
--	----------	---------	------	---------

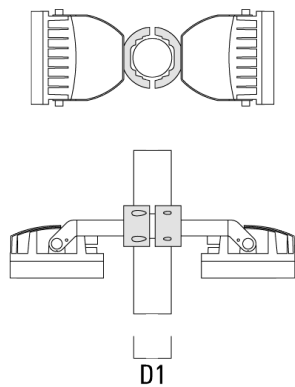

**FLC230 LED**

Description	Part ID	D1	Weight (kg)	D
TS2-2/M12 Pole clamp, double (Ø 102-114)	147-0527	102-114	1.50	102-114

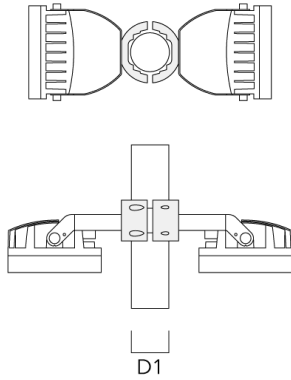

**Planted root**

Description	Part ID	D1	D2	D3	D4	H1	H2	M1	Weight (kg)
Planted root ESV4	300-0461	145	130	102	108	400	350	8	7.05

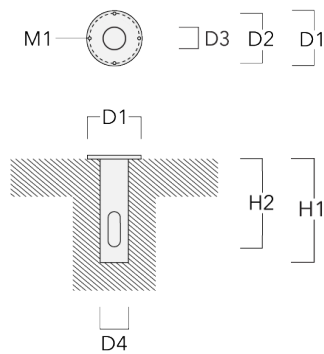

## Pole clamp PC

Description	Part ID	D1	Weight (kg)
PC2 76-89/60 Pole clamp, double (Ø 76-89)	139-2703	76-89	1.00

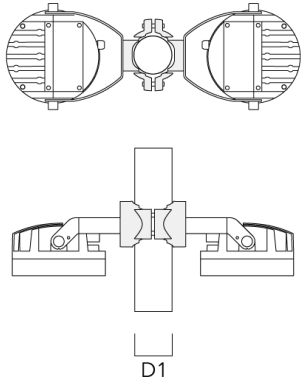

PC1 76-89/60 Pole clamp, single (Ø 76-89)	139-2702	76-89	1.00
---	----------	-------	------

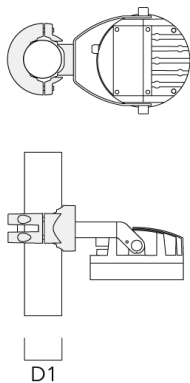

## FLC230 LED

Description	Part ID	D1	Weight (kg)
PC2 102-114/60 Pole clamp, double (Ø 102-114)	139-2707	102-114	1.20



PC1 102-114/60 Pole clamp, single (Ø 102-114)	139-2706	102-114	1.20
--	----------	---------	------



139-1846

FLC230 LED

**we-ef**

---

Description	Part ID	D1	Weight (kg)
PC2 114-133/60 Pole clamp, double (Ø 114-133)	139-2709	114-133	1.40

---



---

PC1 114-133/60 Pole clamp, single (Ø 114-133)	139-2708	114-133	1.40
--	----------	---------	------

---



**WE-EF LEUCHTEN GmbH**

Töpinger Straße 16, 29646 Bispingen, Germany - Phone: +49 5194 909-0  
info@we-ef.com - <https://we-ef.com>

Subject to technical changes and errors. - Generated on 23/11/2024

139-1846

FLC230 LED

**we-ef**

---

Description	Part ID	D1	Weight (kg)
PC2 82-109/60 Pole camp, double (Ø 82-109)	139-2705	82-109	1.10

---



---

PC1 82-109/60 Pole camp, single (Ø 82-109)	139-2704	82-109	1.10
--	----------	--------	------

---

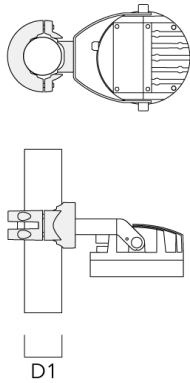

**WE-EF LEUCHTEN GmbH**

Töpinger Straße 16, 29646 Bispingen, Germany - Phone: +49 5194 909-0  
info@we-ef.com - <https://we-ef.com>

Subject to technical changes and errors. - Generated on 23/11/2024



**139-1846**

**FLC230 LED**

**we-ef**

## **Control**

### **Eco Step Dim® Basic**

Description	Part ID
Eco Step Dim® Basic LED	430-0001

### **Eco Step Dim® Advanced**

Description	Part ID
Eco Step Dim® Advanced LED	430-0002

### **R2C Ready to Connect**

Description	Part ID
R2C Ready to Connect (top)	430-0019

139-1846

FLC230 LED

**we-ef**

## Optical Accessories

### Linear spread lens

Description	Part ID	C1
IO-180-FLC230-LED	139-1849	199

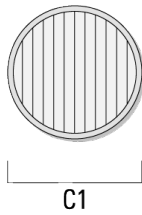

### Flood lens

Description	Part ID	C1
IO-360-FLC230-LED	139-1850	199

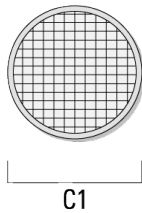

#### WE-EF LEUCHTEN GmbH

Töpinger Straße 16, 29646 Bispingen, Germany - Phone: +49 5194 909-0  
info@we-ef.com - <https://we-ef.com>

Subject to technical changes and errors. - Generated on 23/11/2024

**Honeycomb louvre**

Description	Part ID	C1
IW-FLC230-LED - [E][EE][EES]	139-1851	199

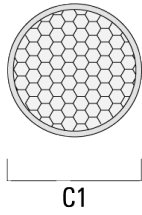

**Glare shield**

Description	Part ID	A	C1
ES-FLC230-LED	139-1852	159	266

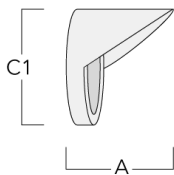

139-1846

FLC230 LED

**we-ef**

**Snoot**

---

Description	Part ID	A	C1
ET-FLC230-LED	139-1853	160	266

---

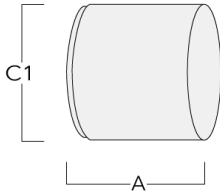

---

**Wallwash lens**

---

Description	Part ID	C1
IO-20-FLC230-LED	139-1848	199

---

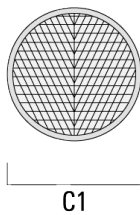

**WE-EF LEUCHTEN GmbH**

Töpinger Straße 16, 29646 Bispingen, Germany - Phone: +49 5194 909-0  
info@we-ef.com - <https://we-ef.com>

Subject to technical changes and errors. - Generated on 23/11/2024