

139-1813

FLC240 LED

**we-ef**



### Description

IP66, Class I. Class II on request. IK07. Marine-grade, die-cast aluminium alloy. 5CE superior corrosion protection including PCS hardware. Silicone CCG® Controlled Compression Gasket. Safety glass lens. One cable gland. Second gland for through wiring on request. Integral EC electronic converter, thermally separated. CAD-optimised optics for superior illumination and glare control. OLC® One LED Concept. Factory installed LED circuit board. 1-10V, DALI Interface or Eco Step Dim® on request. Maximum one internal optical accessory possible.

Optional 2200 K version up to max. 1050mA available, except version [EES]. To be specified at time of ordering.

|                    |                              |
|--------------------|------------------------------|
| Weight             | 12.60 kg                     |
| Light distribution | symmetric, medium beam [M]   |
| Light source       | LED-24/48W / 700 mA - 4000 K |
| CRI                | 80                           |
| Power supply       | EC                           |
| LEDs               | 24                           |
| Rated input power  | 54 W                         |

### Nominal Lumen (lm)

|             |      |
|-------------|------|
| LED Lumen   | 310  |
| Total Lumen | 7440 |
| Tj          | 85   |

### Rated lumens (lm)

|             |        |
|-------------|--------|
| LED Lumen   | 280.8  |
| Total Lumen | 6739.5 |
| Ta          | 25     |

### WE-EF LEUCHTEN GmbH

Töpinger Straße 16, 29646 Bispingen, Germany - Phone: +49 5194 909-0  
info@we-ef.com - <https://we-ef.com>

Subject to technical changes and errors. - Generated on 23/11/2024

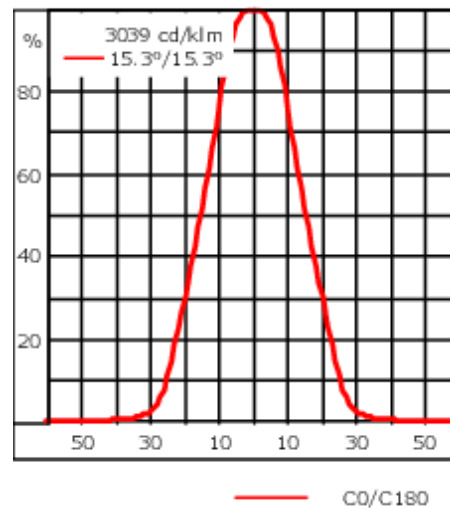
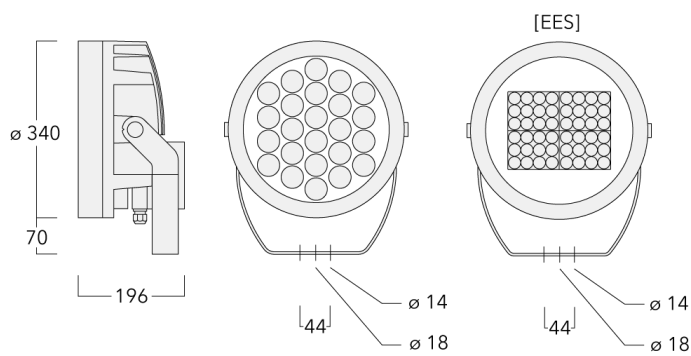

## Specifications

### Material description

|                      |  |
|----------------------|--|
| Body                 | Marine-grade, die-cast aluminium alloy   |
| Lens                 | Safety glass lens  |
| Colours              | <div style="display: flex; align-items: center; gap: 10px;"> <div style="width: 20px; height: 15px; background-color: black; margin-right: 5px;"></div> RAL9004 Signal black         </div> <div style="display: flex; align-items: center; gap: 10px; margin-top: 5px;"> <div style="width: 20px; height: 15px; background-color: #cccccc; margin-right: 5px;"></div> RAL9006 White aluminium         </div> <div style="display: flex; align-items: center; gap: 10px; margin-top: 5px;"> <div style="width: 20px; height: 15px; background-color: #808080; margin-right: 5px;"></div> RAL9007 Grey aluminium         </div> <div style="display: flex; align-items: center; gap: 10px; margin-top: 5px;"> <div style="width: 20px; height: 15px; background-color: #333333; margin-right: 5px;"></div> RAL7016 Anthracite grey         </div> <div style="display: flex; align-items: center; gap: 10px; margin-top: 5px;"> <div style="width: 20px; height: 15px; background-color: #e0e0e0; margin-right: 5px;"></div> RAL9016 Traffic white         </div> |
| Gasket               | Silicone rubber gasket   |
| Fasteners            | PCS Polymer Coated Stainless Steel Hardware  |
| Ingress protection   | IP66   |
| Impact resistance    | IK07   |
| Corrosion resistance | 5CE  |
| Windage              | 0.090 m <sup>2</sup>   |

### Electrical description

|                  |   |
|------------------|---|
| Power supply     | 220-240V / 50-60 Hz   |
| Driver / Ballast | Standard. Optional DALI version available. To be specified at time of ordering. |
| Power factor     | > 0.9   |
| Surge protection | 6/6 kV (optional SP10)  |

### Additional information

|          |                        |
|----------|------------------------|
| Lifetime | Ta=25° L90B10 > 90000h |
|----------|------------------------|

#### WE-EF LEUCHTEN GmbH

Töpinger Straße 16, 29646 Bispingen, Germany - Phone: +49 5194 909-0  
 info@we-ef.com - <https://we-ef.com>  
 Subject to technical changes and errors. - Generated on 23/11/2024

**Mounting Accessories**

**Short post EM**

| Description | Part ID  | D1  | D2  | H1  | M1 | Weight (kg) |
|-------------|----------|-----|-----|-----|----|-------------|
| EM1-M16 AL  | 270-9038 | 160 | 130 | 203 | 9  | 2           |



**Floodlight mounting bracket TA**

| Description                                | Part ID  | A | C1  | D x L1   | Weight (kg) | D x S    |
|--|----------|---|-----|----------|-------------|----------|
| TA1 Mounting bracket, single* (Ø 76 x 200) | 147-0023 |   | 130 | 76 x 200 | 1.90        | 76 x 200 |



| Description                                | Part ID  | A | C1  | D x L1   | Weight (kg) | D x S    |
|--|----------|---|-----|----------|-------------|----------|
| TA2 Mounting bracket, double* (Ø 76 x 200) | 147-0024 |   | 130 | 76 x 200 | 1.90        | 76 x 200 |



|   |          |      |     |          |       |          |
|---|----------|------|-----|----------|-------|----------|
| TA2-L Mounting bracket, double (Ø 76 x 200) | 147-0105 | ±90° | 420 | 76 x 200 | 16.10 | 76 x 200 |
|---|----------|------|-----|----------|-------|----------|



| Description                               | Part ID  | A    | C1  | D x L1   | Weight (kg) | D x S    |
|---|----------|------|-----|----------|-------------|----------|
| TA3 Mounting bracket, triple (Ø 89 x 200) | 147-0025 | ±90° | 650 | 89 x 200 | 17.90       | 89 x 200 |

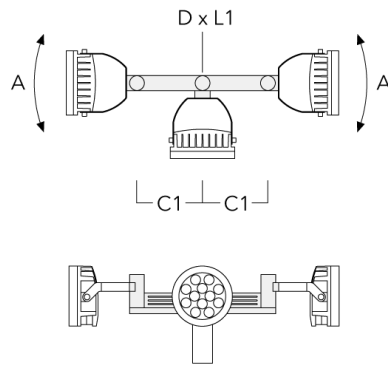

|   |          |      |     |          |       |          |
|---|----------|------|-----|----------|-------|----------|
| TA4 Mounting bracket, quad (Ø 89 x 200) | 147-0099 | ±90° | 650 | 89 x 200 | 20.80 | 89 x 200 |
|---|----------|------|-----|----------|-------|----------|

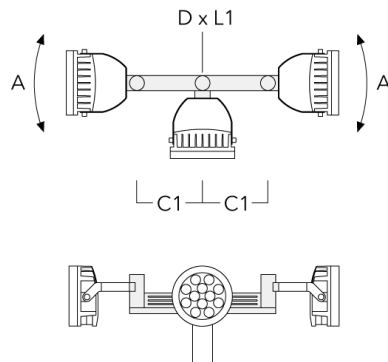

**FLC240 LED**

| Description                                | Part ID  | A | C1  | D × L1    | Weight (kg) | D × S     |
|--|----------|---|-----|-----------|-------------|-----------|
| TA1 Mounting bracket, single (Ø 108 x 200) | 147-0096 |   | 130 | 108 x 200 | 7.50        | 108 x 200 |



|  |          |  |     |           |      |           |
|--|----------|--|-----|-----------|------|-----------|
| TA2 Mounting bracket, double (Ø 108 x 200) | 147-0097 |  | 130 | 108 x 200 | 7.50 | 108 x 200 |
|--|----------|--|-----|-----------|------|-----------|

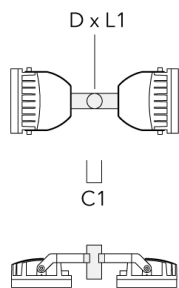

| Description                                  | Part ID  | A    | C1  | D x L1    | Weight (kg) | D x S     |
|--|----------|------|-----|-----------|-------------|-----------|
| TA2-L Mounting bracket, double (Ø 108 x 200) | 147-0148 | ±90° | 420 | 108 x 200 | 20.20       | 108 x 200 |

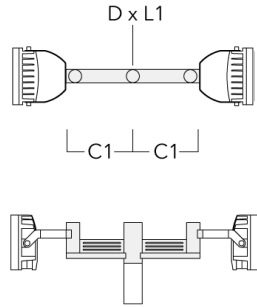

|  |          |      |     |           |       |           |
|--|----------|------|-----|-----------|-------|-----------|
| TA3 Mounting bracket, triple (Ø 108 x 200) | 147-0098 | ±90° | 650 | 108 x 200 | 24.20 | 108 x 200 |
|--|----------|------|-----|-----------|-------|-----------|

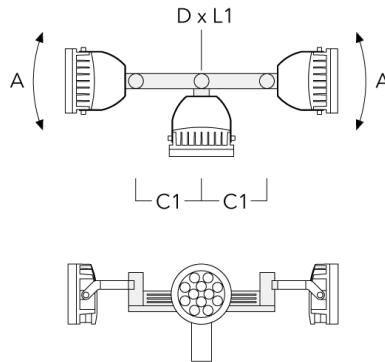

| Description                              | Part ID  | A    | C1  | D × L1    | Weight (kg) | D × S     |
|--|----------|------|-----|-----------|-------------|-----------|
| TA4 Mounting bracket, quad (Ø 108 x 200) | 147-0100 | ±90° | 650 | 108 x 200 | 24.20       | 108 x 200 |

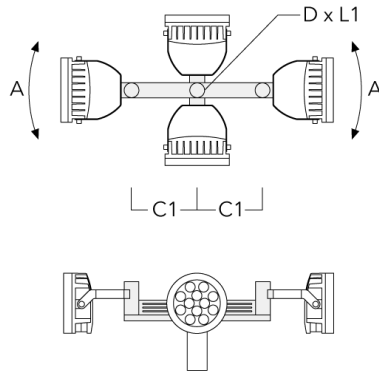

**Pole clamp TS**

| Description                            | Part ID  | D1    | Weight (kg) | D     |
|--|----------|-------|-------------|-------|
| TS1-2/M12 Pole clamp, single (Ø 76-89) | 147-0543 | 76-89 | 1.40        | 76-89 |

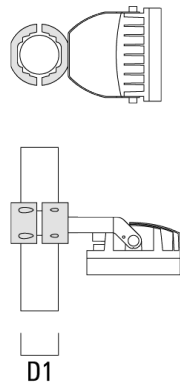



**FLC240 LED**

| Description                              | Part ID  | D1      | Weight (kg) | D       |
|--|----------|---------|-------------|---------|
| TS1-2/M12 Pole clamp, single (Ø 102-114) | 147-0526 | 102-114 | 1.50        | 102-114 |



|  |          |         |      |         |
|--|----------|---------|------|---------|
| TS1-2/M12 Pole clamp, single (Ø 114-133) | 147-0544 | 114-133 | 1.70 | 114-133 |
|--|----------|---------|------|---------|



**FLC240 LED**

| Description                            | Part ID  | D1    | Weight (kg) | D     |
|--|----------|-------|-------------|-------|
| TS2-2/M12 Pole clamp, double (Ø 76-89) | 147-0545 | 76-89 | 1.40        | 76-89 |



|  |          |         |      |         |
|--|----------|---------|------|---------|
| TS2-2/M12 Pole clamp, double (Ø 102-114) | 147-0527 | 102-114 | 1.50 | 102-114 |
|--|----------|---------|------|---------|



| Description                              | Part ID  | D1      | Weight (kg) | D       |
|--|----------|---------|-------------|---------|
| TS2-2/M12 Pole clamp, double (Ø 114-133) | 147-0546 | 114-133 | 1.60        | 114-133 |



**Planted root**

| Description       | Part ID  | D1  | D2  | D3  | D4  | H1  | H2  | M1 | Weight (kg) |
|-------------------|----------|-----|-----|-----|-----|-----|-----|----|-------------|
| Planted root ESV4 | 300-0461 | 145 | 130 | 102 | 108 | 400 | 350 | 8  | 7.05        |

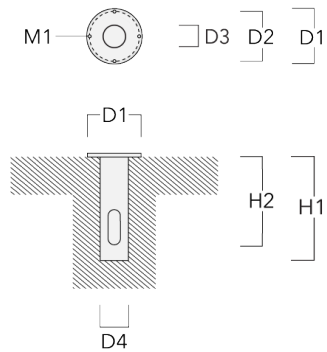

139-1813

FLC240 LED

**we-ef**

**Pole clamp PC**

| Description                               | Part ID  | D1    | Weight (kg) |
|---|----------|-------|-------------|
| PC2 76-89/60 Pole clamp, double (Ø 76-89) | 139-2703 | 76-89 | 1.00        |



|   |          |       |      |
|---|----------|-------|------|
| PC1 76-89/60 Pole clamp, single (Ø 76-89) | 139-2702 | 76-89 | 1.00 |
|---|----------|-------|------|



**WE-EF LEUCHTEN GmbH**

Töpinger Straße 16, 29646 Bispingen, Germany - Phone: +49 5194 909-0  
info@we-ef.com - <https://we-ef.com>

Subject to technical changes and errors. - Generated on 23/11/2024

| Description                                      | Part ID  | D1      | Weight (kg) |
|--|----------|---------|-------------|
| PC2 102-114/60 Pole clamp, double<br>(Ø 102-114) | 139-2707 | 102-114 | 1.20        |



|  |          |         |      |
|--|----------|---------|------|
| PC1 102-114/60 Pole clamp, single<br>(Ø 102-114) | 139-2706 | 102-114 | 1.20 |
|--|----------|---------|------|



139-1813

FLC240 LED

**we-ef**

---

| Description                                      | Part ID  | D1      | Weight (kg) |
|--|----------|---------|-------------|
| PC2 114-133/60 Pole clamp, double<br>(Ø 114-133) | 139-2709 | 114-133 | 1.40        |

---



---

|  |          |         |      |
|--|----------|---------|------|
| PC1 114-133/60 Pole clamp, single<br>(Ø 114-133) | 139-2708 | 114-133 | 1.40 |
|--|----------|---------|------|

---



**WE-EF LEUCHTEN GmbH**

Töpinger Straße 16, 29646 Bispingen, Germany - Phone: +49 5194 909-0  
info@we-ef.com - <https://we-ef.com>

Subject to technical changes and errors. - Generated on 23/11/2024

139-1813

FLC240 LED

**we-ef**

---

| Description                                | Part ID  | D1     | Weight (kg) |
|--|----------|--------|-------------|
| PC2 82-109/60 Pole camp, double (Ø 82-109) | 139-2705 | 82-109 | 1.10        |

---



**WE-EF LEUCHTEN GmbH**

Töpinger Straße 16, 29646 Bispingen, Germany - Phone: +49 5194 909-0  
info@we-ef.com - <https://we-ef.com>

Subject to technical changes and errors. - Generated on 23/11/2024

**139-1813**

**FLC240 LED**

**we-ef**

## **Control**

### **Eco Step Dim® Basic**

| Description             | Part ID  |
|-------------------------|----------|
| Eco Step Dim® Basic LED | 430-0001 |

### **Eco Step Dim® Advanced**

| Description                | Part ID  |
|----------------------------|----------|
| Eco Step Dim® Advanced LED | 430-0002 |

### **R2C Ready to Connect**

| Description                | Part ID  |
|----------------------------|----------|
| R2C Ready to Connect (top) | 430-0019 |



**139-1813**

**FLC240 LED**

**we-ef**

## Optical Accessories

### Flood lens

| Description       | Part ID  | C1  |
|-------------------|----------|-----|
| IO-360-FLC240-LED | 139-1856 | 289 |



### Honeycomb louvre

| Description         | Part ID  | C1  |
|---------------------|----------|-----|
| Honeycomb Louvre IW | 139-1857 | 279 |

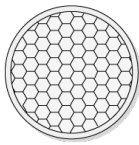

#### WE-EF LEUCHTEN GmbH

Töpinger Straße 16, 29646 Bispingen, Germany - Phone: +49 5194 909-0  
info@we-ef.com - <https://we-ef.com>

Subject to technical changes and errors. - Generated on 23/11/2024

139-1813

FLC240 LED

**we-ef**

### Snoot

| Description   | Part ID  | A   | C1  |
|---------------|----------|-----|-----|
| ET-FLC240-LED | 139-1859 | 200 | 346 |



### Glare shield

| Description   | Part ID  | A   | C1  |
|---------------|----------|-----|-----|
| ES-FLC240-LED | 139-1858 | 200 | 346 |



**WE-EF LEUCHTEN GmbH**

Töpinger Straße 16, 29646 Bispingen, Germany - Phone: +49 5194 909-0  
info@we-ef.com - <https://we-ef.com>

Subject to technical changes and errors. - Generated on 23/11/2024

139-1813

FLC240 LED

**we-ef**

### Wallwash lens

| Description      | Part ID  | Additional information                       | C1  |
|------------------|----------|--|-----|
| IO-20-FLC240-LED | 139-1854 | for symmetric [M] medium beam luminaire only | 289 |



### Linear spread lens

| Description               | Part ID  | C1  |
|---------------------------|----------|-----|
| Linear spread lens IO-180 | 139-1855 | 289 |

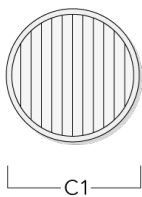

#### WE-EF LEUCHTEN GmbH

Töpinger Straße 16, 29646 Bispingen, Germany - Phone: +49 5194 909-0  
info@we-ef.com - <https://we-ef.com>

Subject to technical changes and errors. - Generated on 23/11/2024