

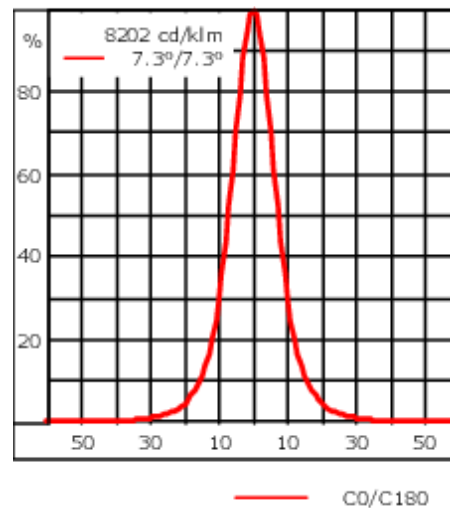

**Description**

IP66, Class I. IK07. Marine-grade, die-cast aluminium alloy. 5CE superior corrosion protection + primer including PCS hardware. Silicone CCG® Controlled Compression Gasket. Safety glass lens. Two cable glands for improved wiring flexibility. Integral EC electronic converter, thermally separated. CAD-optimised optics for superior illumination and glare control. OLC® One LED Concept. Factory installed LED circuit board. 1-10V, DALI Interface or Eco Step Dim\_R\_ on request. Maximum one internal optical accessory possible. Optional 2200 K version available, except version [EES]. To be specified at time of ordering.

Weight	12.60 kg
Light distribution	symmetric, narrow beam [E]
Light source	LED-24/72W / 1050 mA - 3000 K
CRI	80
Power supply	EC
LEDs	24
Rated input power	81 W
<b>Nominal Lumen (lm)</b>	
LED Lumen	430
Total Lumen	10320
Tj	85
<b>Rated lumens (lm)</b>	
LED Lumen	366.4
Total Lumen	8794.3
Ta	25

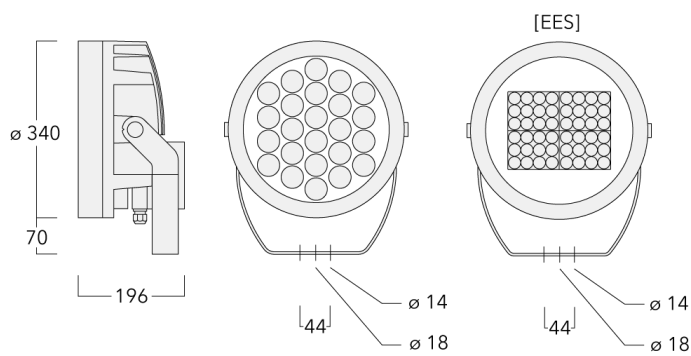

## Specifications

### Material description

Body	Marine-grade, die-cast aluminium alloy
Lens	Safety glass lens
Colours	<div style="display: flex; align-items: center;"> <div style="width: 20px; height: 15px; background-color: black; margin-right: 5px;"></div> <span>RAL9004 Signal black</span> </div> <div style="display: flex; align-items: center; margin-top: 5px;"> <div style="width: 20px; height: 15px; background-color: #cccccc; margin-right: 5px;"></div> <span>RAL9006 White aluminium</span> </div> <div style="display: flex; align-items: center; margin-top: 5px;"> <div style="width: 20px; height: 15px; background-color: #808080; margin-right: 5px;"></div> <span>RAL9007 Grey aluminium</span> </div>
Gasket	Silicone rubber gasket
Fasteners	PCS Polymer Coated Stainless Steel Hardware (unpainted)
Ingress protection	IP66
Impact resistance	IK07
Corrosion resistance	5CE+Primer
Windage	0.090 m <sup>2</sup>

### Electrical description

Power supply	230V / 50 Hz
Driver / Ballast	Integral EC electronic convertor in thermally-separated compartment
Power factor	> 0.9
Surge protection	6/6 kV (optional SP10)

### Additional information

Lifetime	Ta=40° L90B10 > 90000h
Warranty	The product is supplied with 10-year warranty. Please refer to the LED Warranty Statement located on <a href="http://www.we-ef.com">www.we-ef.com</a> for further details.

**Mounting Accessories**

**Short post EM**

Description	Part ID	D1	D2	H1	M1	Weight (kg)
EM1-M16 AL	270-9038	160	130	203	9	2.10



**Floodlight mounting bracket TA**

Description	Part ID	A	C1	D x L1	Weight (kg)	D x S
TA1 Mounting bracket, single* (Ø 76 x 200)	147-0023		130	76 x 200	1.90	76 x 200



Description	Part ID	A	C1	D x L1	Weight (kg)	D x S
TA2 Mounting bracket, double* (Ø 76 x 200)	147-0024		130	76 x 200	1.90	76 x 200



TA2-L Mounting bracket, double (Ø 76 x 200)	147-0105	±90°	420	76 x 200	16.10	76 x 200
---	----------	------	-----	----------	-------	----------



139-1820

FLC240 LED

**we-ef**

Description	Part ID	A	C1	D x L1	Weight (kg)	D x S
TA3 Mounting bracket, triple (Ø 89 x 200)	147-0025	±90°	650	89 x 200	17.90	89 x 200



TA4 Mounting bracket, quad (Ø 89 x 200)	147-0099	±90°	650	89 x 200	20.80	89 x 200
---	----------	------	-----	----------	-------	----------



**WE-EF LIGHTING Pty Ltd**

6/13 Downard Street, 3195 Braeside, Victoria - Phone: +61 3 8587 0444 - Fax: +61 3 8587 0499

info.australia@we-ef.com - <https://we-ef.com/aus>

Subject to technical changes and errors. - Generated on 23/11/2024

**FLC240 LED**

Description	Part ID	A	C1	D × L1	Weight (kg)	D × S
TA1 Mounting bracket, single (Ø 108 x 200)	147-0096		130	108 x 200	7.50	108 x 200



TA2 Mounting bracket, double (Ø 108 x 200)	147-0097		130	108 x 200	7.50	108 x 200
--	----------	--	-----	-----------	------	-----------



Description	Part ID	A	C1	D x L1	Weight (kg)	D x S
TA2-L Mounting bracket, double (Ø 108 x 200)	147-0148	±90°	420	108 x 200	20.20	108 x 200

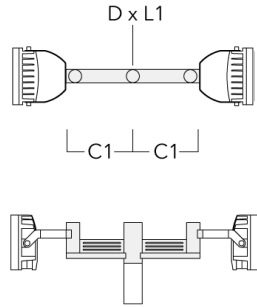

TA3 Mounting bracket, triple (Ø 108 x 200)	147-0098	±90°	650	108 x 200	24.20	108 x 200
--	----------	------	-----	-----------	-------	-----------



Description	Part ID	A	C1	D × L1	Weight (kg)	D × S
TA4 Mounting bracket, quad (Ø 108 x 200)	147-0100	±90°	650	108 x 200	24.20	108 x 200

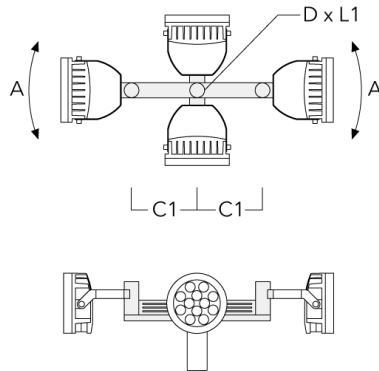

**Planted root**

Description	Part ID	D1	D2	D3	D4	H1	H2	M1	T1	T2	Weight (kg)
Planted root ESV4	300-0461-AP	150	130	60	89	400	350	8	200	50 x 100	3.85





139-1820

FLC240 LED

**we-ef**

**Spigot cap KF**

Description	Part ID	D1	Weight (kg)
KF1-M16 Spigot Cap (ø 60 x 100)	310-9120	60 x 100	1.40



KF1-M16 Spigot Cap (ø 76 x 100)	310-9121	76 x 100	2.2
---------------------------------	----------	----------	-----



139-1820

FLC240 LED

**we-ef**

**Pole clamp PC - Rotatable**

Description	Part ID	D1	Weight (kg)
PC2 76-89/60 Pole clamp, double (Ø 76-89)	139-2703	76-89	1.00



PC1 76-89/60 Pole clamp, single (Ø 76-89)	139-2702	76-89	1.00
---	----------	-------	------

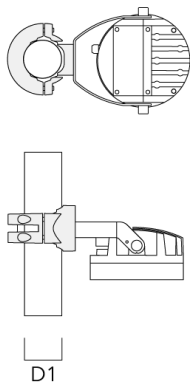

**WE-EF LIGHTING Pty Ltd**

6/13 Downard Street, 3195 Braeside, Victoria - Phone: +61 3 8587 0444 - Fax: +61 3 8587 0499

info.australia@we-ef.com - <https://we-ef.com/aus>

Subject to technical changes and errors. - Generated on 23/11/2024

139-1820

FLC240 LED

**we-ef**

---

Description	Part ID	D1	Weight (kg)
PC2 102-114/60 Pole clamp, double (Ø 102-114)	139-2707	102-114	1.20

---



---

PC1 102-114/60 Pole clamp, single (Ø 102-114)	139-2706	102-114	1.20
--	----------	---------	------

---



139-1820

FLC240 LED

**we-ef**

---

Description	Part ID	D1	Weight (kg)
PC2 114-133/60 Pole clamp, double (Ø 114-133)	139-2709	114-133	1.40

---



---

PC1 114-133/60 Pole clamp, single (Ø 114-133)	139-2708	114-133	1.40
--	----------	---------	------

---



**WE-EF LIGHTING Pty Ltd**

6/13 Downard Street, 3195 Braeside, Victoria - Phone: +61 3 8587 0444 - Fax: +61 3 8587 0499

info.australia@we-ef.com - <https://we-ef.com/aus>

Subject to technical changes and errors. - Generated on 23/11/2024

**139-1820**

**FLC240 LED**

**we-ef**

---

Description	Part ID	D1	Weight (kg)
PC2 82-109/60 Pole camp, double (Ø 82-109)	139-2705	82-109	1.10

---



**WE-EF LIGHTING Pty Ltd**

6/13 Downard Street, 3195 Braeside, Victoria - Phone: +61 3 8587 0444 - Fax: +61 3 8587 0499

info.australia@we-ef.com - <https://we-ef.com/aus>

Subject to technical changes and errors. - Generated on 23/11/2024

**139-1820**

**FLC240 LED**

**we-ef**

## **Control**

### **Eco Step Dim® Basic**

Description	Part ID
Eco Step Dim® Basic LED	430-0001

### **Eco Step Dim® Advanced**

Description	Part ID
Eco Step Dim® Advanced LED	430-0002

### **1-10 V analogue dimming interface**

Description	Part ID	C
1-10 V analogue dimming interface	430-0011	90

---

### **R2C Ready to Connect**

Description	Part ID
R2C Ready to Connect (top)	430-0019

**WE-EF LIGHTING Pty Ltd**

6/13 Downard Street, 3195 Braeside, Victoria - Phone: +61 3 8587 0444 - Fax: +61 3 8587 0499

info.australia@we-ef.com - <https://we-ef.com/aus>

Subject to technical changes and errors. - Generated on 23/11/2024

139-1820

FLC240 LED

**we-ef**

## Optical Accessories

### Surface wash lens

Description	Part ID	C1
IO-360-FLC240-LED	139-1856	289

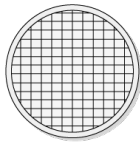

### Honeycomb louvre

Description	Part ID	C1
Honeycomb Louvre IW	139-1857	279



#### WE-EF LIGHTING Pty Ltd

6/13 Downard Street, 3195 Braeside, Victoria - Phone: +61 3 8587 0444 - Fax: +61 3 8587 0499

info.australia@we-ef.com - <https://we-ef.com/aus>

Subject to technical changes and errors. - Generated on 23/11/2024

139-1820

FLC240 LED

**we-ef**

**Snoot**

---

Description	Part ID	A	C1
ET-FLC240-LED	139-1859	200	346

---



---

**Glare shield**

---

Description	Part ID	A	C1
ES-FLC240-LED	139-1858	200	346

---



**WE-EF LIGHTING Pty Ltd**

6/13 Downard Street, 3195 Braeside, Victoria - Phone: +61 3 8587 0444 - Fax: +61 3 8587 0499

info.australia@we-ef.com - <https://we-ef.com/aus>

Subject to technical changes and errors. - Generated on 23/11/2024



139-1820

FLC240 LED

**we-ef**

### Wallwash lens

Description	Part ID	Additional information	C1
IO-20-FLC240-LED	139-1854	for symmetric [M] medium beam luminaire only	289

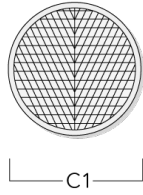

### Linear spread lens

Description	Part ID	C1
Linear spread lens IO-180	139-1855	289

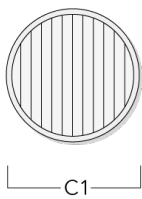

**WE-EF LIGHTING Pty Ltd**

6/13 Downard Street, 3195 Braeside, Victoria - Phone: +61 3 8587 0444 - Fax: +61 3 8587 0499

info.australia@we-ef.com - <https://we-ef.com/aus>

Subject to technical changes and errors. - Generated on 23/11/2024